

RIOT  
CONTROL



**Stock Photo:** Masked protester with clenched fist, holding a blank placard for you to add your own text  
**Image ID:** 6401509

**Release information:** Signed model release filed with Shutterstock Images LLC

**Keywords:** activist, amnesty, anarchist, anarchy, anger, anti, background, banner, campaigner, civil, demand, demo, democracy, democratic, demonstration, demonstrator, disguise, eco, face, hooligan, hostile, isolated, man, mask, masked, movement, notice, opinion, peace, people, person, placard, political, politics, protester, rally, rebel, rights, rioter, sign, social, socialist, statement, strike, uprising, violence, war, warrior, white, yob

*shatter-proof swim goggles  
with good seal*

*bandana soaked in  
apple cider vinegar*

*hat to protect hair from  
chemicals and face/  
eyes from sun*

*comfortable backpack or  
fanny pack filled with food,  
extra clothes, hygiene  
products, hand warmers,  
band-aids, & lots of water*

*mittens or gloves  
(because we can't  
draw hands)*

## **the Proper Protestor**

*long sleeves and long pants*

*closed-toed shoes or  
steel-toed boots*

***Out in the streets, style  
takes a back seat to  
utility. When the state is  
breathing down your neck  
with an arsenal of chemical  
and other "less lethal"  
weaponry, looking good  
means being dressed for  
safety. Paul(ine) models the  
latest Spring protest  
fashions.***

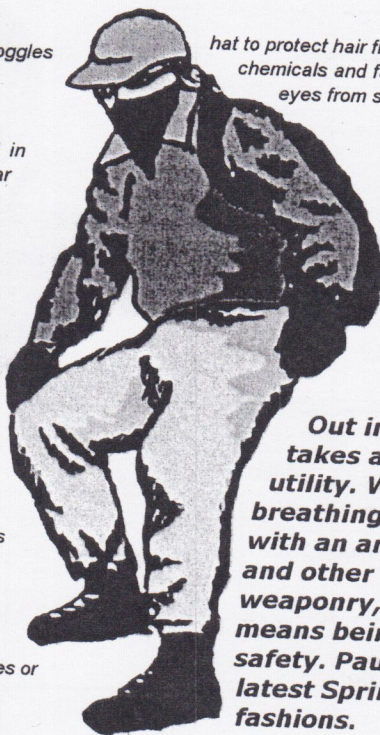



## ANTI RIOT SUIT

Helmet with ballistic

Screen laminated  
ballistic

Mittens barrier moves,  
armor and flak.  
Protection: main (outer  
side) wrist  
Performance level: IIIA NIJ  
0101.04  
Weight: 0.83 kg  
Sizes: S, M, L, XL

Protects shoulders barrier moves,  
armor and flak.  
Lacing on the sides support belt  
performance level: IIIA NIJ 0101.04  
Weight: 2.32 kg L / XL  
Sizes: S / M, L / XL, XXL / XXXL

Cuff shield blows, armor and flak  
Performance level: IIIA NIJ 0101.04  
Weight: 2.28 kg in size L  
Sizes: S, M, L, XL

Barrier protects thighs shots, armor and flak.  
Mountings and settings: velcro straps.  
Performance level: IIIA NIJ 0101.04  
Weight: 2.24 kg in size L / XL  
Sizes: S / M, L / XL

Leggings barrier moves, armor and flak.  
Mountings and settings: velcro straps  
Performance level: IIIA NIJ 0101.04  
Weight: 3.36 kg in size L  
Sizes: XS, S, M, L, XL

Body armor

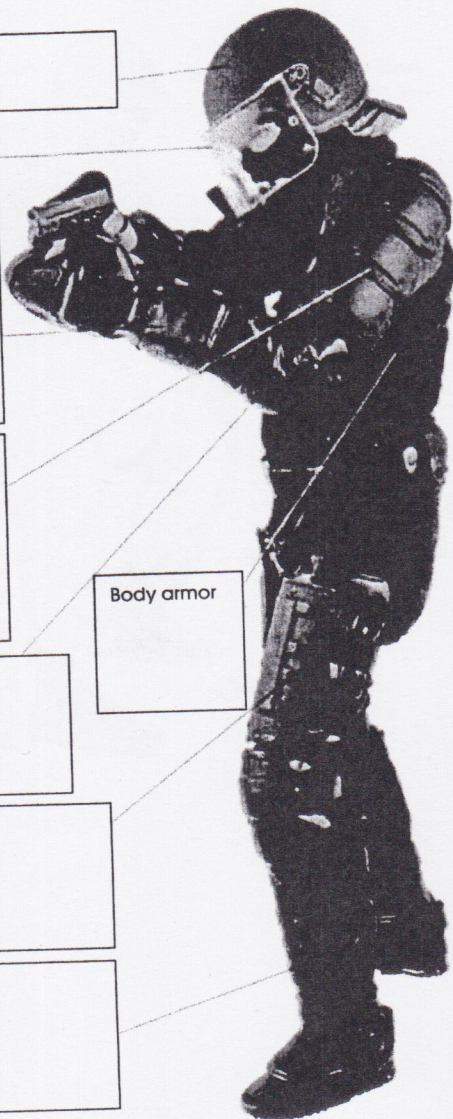

# Necessary Clothing and Accessories

Sweatshirt or leather jacket with a hood.  
This helps shield your face from tear gas.

The lid of a pot: you can use  
this shield when the State Security  
beats you or shoots rubber  
bullets.

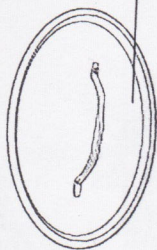

Thick rubber gloves in order  
to protect your hands from  
the heat of tear gas containers



Protective glasses  
(Can be bought at any  
metalworking or paint shop)



Scarf to protect your  
mouth and lungs  
from tear gas



A rose so we can show that  
we can do as we ought to and  
join together in the most  
peaceful way possible

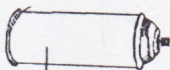

Spray Paint so that if the authorities  
attack us, we can spray paint the  
visors of their helmets and the  
windshields of the armored trucks,  
blocking their vision and hindering  
their movement



Shoes that make it easy to run  
and move quickly.

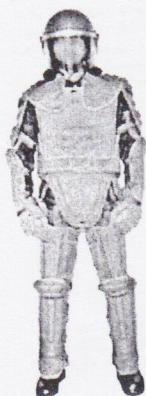
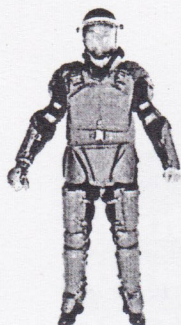



## Fashion Tips for the Brave

Do you desire to be an autonomous individual rather than a faceless, mass-produced cog in the machine? Great! That is, unless you are marching in a bloc—where conformity is a weapon that you can use to smash the machine itself.

The goal of the bloc as a tactic is to have everyone look as similar as possible, so that, ideally, no single individual can be identified within the anonymous mass. This helps to keep everybody safer. If only some people within a bloc take these precautions, the cops can more easily spot and target individuals and groups, which is dangerous both for those who are acting within the bloc and for those who are not. Those who make the effort to stay anonymous can draw extra police attention; those who don't can be more easily identified, which can make them easier targets. Neither of these situations is desirable.

Take this stuff seriously! If you're setting out to accomplish something risky, taking these precautions is crucial. If you're not, you can help to protect your comrades and avoid making yourself a target.

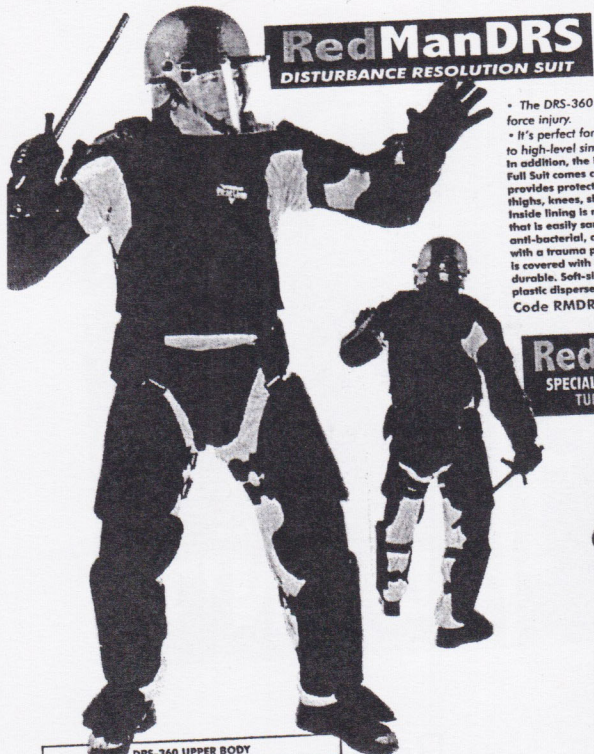

# RedMan DRS

## DISTURBANCE RESOLUTION SUIT

• The DRS-360 Suit is designed with full body coverage to protect against blunt force injury.  
 • It's perfect for cell extractions, riot and crowd control, subject control tactics, low to high-level simulation and other force on force training.  
 In addition, the DRS line is modular, allowing custom configurations. The DRS-360 Full Suit comes complete with the DRS-360 Upper Body and Lower Body. The full suit provides protection and coverage for the chest, back, shoulders, arms, rear, groin, hips, thighs, knees, shins and instep. 3-layer construction.  
 Inside lining is made of Dartex, a patented, waterproof polyurethane-coated nylon that is easily sanitized and dried. Lining is impervious to bloodborne pathogens, with anti-bacterial, antifungal properties. Inner layers feature closed-cell foam construction with a trauma plate sandwiched between the foam for added protection. Outside layer is covered with Nomex™, making it flame resistant, water resistant and extremely durable. Soft-sided interior and exterior protects both officer and inmate. Inner layer of plastic disperses impact and adds a level of protection. FOR SIZES SEE CHARTS.  
 Code RMDRS360

# RedMan TRAINING

## SPECIALIST SIMULATION TRAINING COURSES

TURN TO NITON TRAINING SECTION

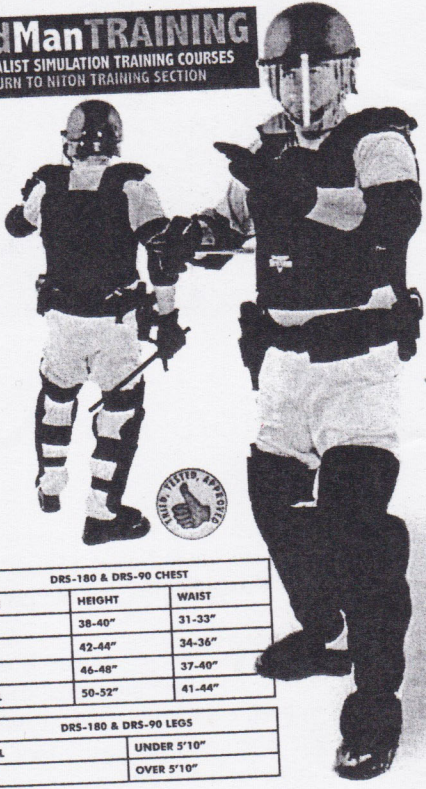

DRS-360 UPPER BODY		
SIZE	HEIGHT	WEIGHT
L	UP TO 5'10"	UP TO 180lbs
XL	5'10"-6'2"	180lbs-220lbs
XXL	OVER 6'-2"	OVER 220lbs

DRS-360 LOWER BODY		
ONE SIZE FITS ALL - ADJUSTABLE STRAPS FOR LENGTH		

DRS-180 & DRS-90 CHEST		
SIZE	HEIGHT	WAIST
M	38-40"	31-33"
L	42-44"	34-36"
XL	46-48"	37-40"
XXL	50-52"	41-44"

DRS-180 & DRS-90 LEGS	
M/L	UNDER 5'10"
XL	OVER 5'10"

**FOR LAW ENFORCEMENT,  
PUBLIC ORDER & PRISONS  
OPERATIONS & TRAINING**

### DRS-90 FULL SUIT

• The DRS-90 is the most economical option in front-line duty and training gear.  
 • It provides top-of-the-line protection for the most vulnerable areas of the legs and torso without the need for costly enhanced fabrics and materials that are best suited for front-line duty environments requiring flame resistance. Features multi-layered blunt trauma protection with durable Cadura fabric to resist abrasions. Access to duty belt, with ability to shoulder stock weapon and wear load-bearing vest. DRS-90 comes complete with the DRS-90 Chest and DRS-90 Legs. DRS-90 covers your chest, back, shoulders, lower thigh, knee, shin and foot.  
 NOTE: DRS-90 is not flame resistant. USE DRS-180 FOR SIZES.  
 Code DRS90

### DRS-180

• The DRS-180 provides critical coverage to torso, legs and elbows against blunt force injury.  
 • The DRS-180 features flame resistant Nomex™ exterior with Dartex™ inner lining that can be cleaned and disinfected to protect from sweat, odour, blood-borne and other pathogens.  
 The DRS Torso offers maximum blunt trauma protection to the chest and back. It can be worn with ballistic or stab resistant vests. Contoured design makes it easy to move while the inner foam layer makes it more comfortable.  
 The DRS Elbows protect and Support the Elbow Joint of Officers  
 The DRS 180 Legs protect the front portion of the upper thighs, knees and shins. The DRS 180 Legs protect the front portion of the upper thighs, knees and shins. Protect the legs from rocks, stones and other objects that can be thrown at an officer during a protest.  
 Designed to be worn over ballistic or stab resistant vest and allows for clear access to duty belt. Enables officer to shoulder stock a weapon and wear a load-bearing vest. FOR SIZES SEE CHARTS.  
 Code DRS180

## Protective Measures:

- **Gloves:** in order of usefulness: **nitrile** (recommended) > vinyl > latex. Nitrile gloves are recommended because they offer the best chemical protection and do not cause latex allergy in the wearer or patients. Latex offers no protection against solvents such as methylene chloride. Butyl gloves (5mm or greater) have the absolute best protection against all chemical agents, but are awkward and not disposable. All of these gloves will melt, so avoid contact with hot tear gas canisters, etc.
- **Safety Glasses:** For biohazard & ballistic protection. OSHA Spec.# "Z87" or "Z87.1" must be stamped somewhere on the glasses. Lab-, machinist'- or EMT-style. US Army makes cheap "sand/dust" goggles costing about \$4 with an optional hard polycarbonate ballistic lens (engraved:"ballistic," sold in a cloth baggie), and if you duct tape/plug the air vents, you've got basic all-round protection. The highest military specification is MIL V-43511C
- **Respiratory Protection:**
  - Level 1:** Bandana & Vinegar (kept wet in a ziplock bag until needed), Surgical/dust mask (US: **N95**, EU: **FFP2**; ~\$2/€2 each). This is not enough if you're planning direct action, are going to be doing video work on the frontlines, want to run with a medical team, etc.
  - Level 2:** Toxic Particulate Respirator — looks like a thick, baggy surgical mask with avale (US: **P100**; EU: **FFP3**, ~\$8/€12).
  - Level 3:** Gas Masks (*see below*)

[brand names, nations, and organizations not meant as endorsements — steal the shit wherever possible!]

**Commercial:** Mine Safety Appliances, North, 3M, Scott, Dräger, etc.

### Military:

US: M40-series [\$60]

MCU-2/P (single large flexible lens; comfortable; use only with hard polycarbonate ballistic lens cover) [\$\$\$] are produced and issued for US imperial quagmires.

M17-series (use with hard polycarbonate ballistic lens covers; filters are hard to change) [\$30]

NATO: Canada, Germany, Britain, all produce very good gas masks [\$-\$\$].

Israel: *Civil Model:* the round, glass eyepieces are NOT shatterproof, as people learned at N30 when police targeted and shot through their eyepieces with rubber bullets [\$20].

*Army Model* (large triangular lenses): as good as US/NATO masks [\$60 new/surplus].

Russian: Avoid USSR masks! They can contain unsafe filter materials (e.g. asbestos), are uncomfortable, & lenses can shatter. They're the gray-green Aardvark-masks in the photo below.

Former East Germany: M10M mask (clone of US M17, so filters are hard to change) and a better mask with 40mm filter. [as cheap as 7€!]

Other Former East Bloc: Case by case, some good, some terrible.

WW2 SURPLUS = JUNK!! — leave 'em on the mannequin at the store...

**NOTE:** Wash newly obtained surplus gas masks before use in warm, soapy water (remove filters beforehand!). You never know what they were used for before they got to the surplus store. Also wash them after returning home from an action if you've been exposed.



**Mask Clearance:** 1. Hold your breath. 2. Put mask on. 3. Pull straps tight. 4. Cover the filter air inlet with your hand and exhale. This forces any contaminated air in the mask out through the outlet valve. 5. Check the mask's seal on your face by inhaling with the inlet valve still covered. A properly fitting mask should be sucked onto your face if you cover the inlet valve, and you should feel no air rushing in around your hairline, chin, etc.



### *Riot Training Suit With Accessories*

**Manufacturer:** Fist, Inc.  
**Vendor:** Aardvark Tactical, Inc.  
**Approximate Cost:** \$638.50

**Participating Services:** Army, Marines, Air Force

**Description:** The Fist 333 riot training suit is the most comprehensive defense tactics suit available. It weighs only 15 pounds and is capable of receiving full-force blows from real-impact weapons, such as the Monadnock 23/36 riot baton. The Fist 333 comes equipped with protection for the chest, back, shoulders, biceps, forearms, groin, buttocks, thighs, and shins; a helmet; and a carrying bag. Glove attachments are not included but should be added for greater protection.

**Operational Capabilities/Use:** This suit provides full-body protection to those engaged in close combat training. It is designed to absorb blows inflicted by a riot baton.

---

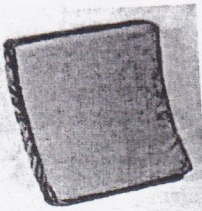

### *Riot Training Bag*

**Manufacturer:** Monadnock  
**Vendor:** Aardvark Tactical, Inc.  
**Approximate Cost:** \$80.00

**Participating Services:** Army, Marines, Air Force

**Description:** The Monadnock riot training bag is designed to meet the needs of defensive tactics instruction for unarmed strikes and baton training.

**Operational Capabilities/Use:** This punch/striking bag is used for training purposes.

---



## Dress for Success

First, take out all *piercings* – they let your flesh get easily torn. Remove contacts and replace with glasses, since if any form of pepper-spray is used your contacts will trap it inside and you might lose your vision forever. Don't dress in sweaters or fleece either – that traps chemicals also. Wash your clothes several times in detergent-free soap (detergents enhance the police's chemical weapons effects), like *Castille Soap*, and the "Original" Dr. Bronner's works. Wash your body with Castille soap, and do not use chemical-trapping oils, moisturizers, Vaseline, makeup or sunscreen. If you have long-hair, tie in back in a pony tail or braid, so it can't be grabbed by an attacker. Always wear light clothing, synthetic and water-repellant if possible – since that will also deflect chemicals. You should also be able to run in your shoes, and reinforced shoes such as steel-toe boots that protect your feet from being run-over are best. Write the *legal number* (where to call when you get arrested) in permanent black marker a few places on your body where sweat won't make it disappear!

To protect your eyes and lungs from tear gas, get a *gas mask* with shatter-proof lenses. US M17 masks are good. Less obvious and cheaper than a gas mask is a *bandana soaked in vinegar* – or even carrying around a fresh lime with a hole in it so you can re-soak your banana in lime juice! Always have back-up and pre-soaked bandanas in a zip-lock bag. Just apply it to your mouth to breathe through when tear-gas starts coming at you.



*"Be Prepared" - armor can come in very useful*

If you want to have armor of some type for defense, you can do-it-yourself. An outer hard layer of cardboard or plastic with a soft inner shell of foam works well, bonded with duct-tape. However, it most important to cover your most easily damaged parts – your joints and neck. Joints can be covered in foam and then duck tape, and padded gloves will protect your fingers. A rubber glove over the top of that will allow you to pick up hot tear gas canisters and throw them back. Your neck can be protected in the back by some hard shell that is connected to a helmet, or a scarf.

Your head is definitely the part of your body that needs the most defense. Bicycle helmets are light but don't protect the back of your head or face, so something like a football helmet (mask removed) or motorcycle helmet works well. Hardhats and hockey masks are cheaper – just make sure to attach with sturdy elastic.



**SENTINEL**  
TACTICAL GEAR



## XTAC UPPER BODY PROTECTION SYSTEM

An improved version of the EVA upper body protection system. The XTAC offer hard shell shoulder and upper arm protection, improved contour design that fits the body like a glove as well as an integrated Hydration Bladder pocket.



- ✦ Hard shell shoulder protector for increased Blunt force protection
- ✦ Supplied with adjustable shoulder straps and waist Velcro straps resulting in a tight, secure fit
- ✦ Hydration Bladder pocket (sold separately)
- ✦ Adjustable, removable groin protector
- ✦ Lower back extension protects tailbone
- ✦ Utility pocket



WARNING: To be used only by authorized and trained Law Enforcement, Corrections, Military and Police Personnel

ALL SPECIFICATIONS ARE SUBJECT TO CHANGE WITHOUT PRIOR NOTICE

January 2010

- Don't just cover your face! Bandanas are popular and convenient, but they don't conceal enough. Cover your head completely so your hair cannot be seen—especially if it's distinctive. In a black bloc, you can do this by wearing a ski mask or making a mask out of a T-shirt—stretch the neck hole across your eyes and tie the sleeves behind your head, with the rest of the shirt covering your head and shoulders. In other circumstances, you could try a wig, if that fits the aesthetic of your action.
- If possible, cover your eyes. Goggles can do this while serving the dual purpose of protecting your eyes from chemical weapons; nondescript sunglasses could also work in a pinch. Both of these can be obtained in prescription form and are better to use than your regular glasses, particularly if your regular glasses are distinctive. Contact lenses are not recommended in situations where you may come into contact with chemical weapons.
- Be careful not to leave fingerprints and DNA evidence! Wear cloth gloves—leather and latex can retain fingerprints and even pass them on to objects you touch. Wipe down tools and other items with alcohol in advance, to clean fingerprints off them—→ you never know what might get lost in the chaos. Don't forget about the batteries inside flashlights!
- Practice at home! Don't go out in a bulky outfit you've never worn before expecting to pull off cop-shocking feats of dexterity. You need to be familiar with your outfit and comfortable moving in it; it's important that your vision isn't compromised, too.
- Do not let any of this give you a false sense of security. Be careful! Assess your relationship to risk honestly; don't do anything if you're not sure you could live with the worst possible consequences. Stay aware of your surroundings and listen to your instincts. Make sure you know and trust the people you're working with, especially when it comes to high-risk activities. Practice proper security culture at all times. Know and assert your legal rights, especially in stressful situations. Doing so may not make things better, but failing to do so will certainly make them worse!

Don't get caught! Stay safe(r), and smash the state!



## CENTURION™ SOFT SHELL RIOT CONTROL SYSTEM

This protective piece is a must for riot control and cell extractions, effectively protecting the torso and shoulders from blunt force trauma. The lightweight, cellular pad design provides ample protection and allows excellent mobility. Includes attachment points for our HUEX100 Hydration System.



### Sizing

Sizing measurements for the Centurion System can be found in chart form on page 49.

### REFLECTIVE LABELS

**POLICE**

6595 Police

**SHERIFF**

6596 Sheriff

**CORRECTIONS**

6597 Corrections

• Hook and loop compatible

• 3" W x 8 11/16" L x 1/8" D

• Not shown: State (6772)

### CPX2500 Centurion™ Upper Body and Shoulder Protection

- Torso protection consists of durable EVA foam with 7 mm sponge foam on the interior for comfort
- Shoulder pads feature hard-shell plastic plates with durable foam padding
- The neck roll consists of 40 mm high-density sponge foam
- All padding is encased in black polyester mesh rigging. The interior is coated with polyester brushed tricot for comfort
- Adjustable shoulder straps, waist straps and contoured design allow a secure fit comfortable enough for long-term wear
- Will safely absorb blows delivered from blunt objects, but does not provide ballistic protection
- Adjustable hook and loop closures and fasteners
- Weighs approximately 2 lbs. (.9 kg) and packaged in a nylon drawstring bag for convenient storage
- Reflective POLICE, SHERIFF, or CORRECTIONS labels are available and can be affixed to the front or rear of the system
  - 8 11/16" L x 3" W x 1/8" H (22.06625 cm x 7.62 cm x 0.3175 cm)
- Sizes S, M, L, XL



**HATCH**

Clothing is the one essential feature of the bloc tactic, and the rock upon which it rests or founders. Far away from the action itself, you may want to practice moving and acting freely in your bloc gear, so you won't still be getting used to it when it's too late. The whole idea of a bloc is to look indistinguishable from each other, so make sure whatever your bloc theme is, everyone is on the same page about it, and that your own clothing doesn't bear any features that distinguish it. In a worst-case scenario, you can make a t-shirt into a mask: use the neck hole for your eyes, and tie the sleeves behind your head.

Your clothing should protect you from the hazards you expect, while not weighing you down unnecessarily; it should be adaptable should unexpected situations arise. Layers are key: if possible, wear an outer layer in which to travel to the bloc action, a layer of bloc clothing, and then another layer of getaway clothing beneath this—without risking heat stroke, of course. In some situations, it may be more sensible to carry the outer layer of your getaway layer in a sealed bag, in case you are covered in paint or tear gas by the time you need to use it. Consult the *Health Care* recipe (pg. 275) for information on how to handle chemical weapons attacks, if you risk incurring them. I've read that ear plugs can offer some protection against concussion grenades, but how one is supposed to know when to put them in and when to have them out so as to be appropriately attentive is beyond me. If you expect to risk receiving blows or projectile fire, wear body armor of some kind (protective sports gear can suffice) and foam or padding, and a bicycle or motorcycle helmet.

Slapstick as it is, it often happens that comrades who discussed and prepared together will not be able to recognize each other in their bloc gear on the day of the action. You may want to identify yourselves to each other early on, especially people from different cities and affinity groups who intend to work together, so it will be easier to keep up with each other in the chaos.

The moment the bloc forms can be pivotal. Where and when to mask up is a hard question. If you do it too late, once you've joined the bloc, you risk being identified; if you do it too early, before you've joined the bloc, you risk being nabbed by the police. Little masked groups walking around before or after events are perfect targets for their enemies. At a big demonstration, one of the best options is to get in your gear in the midst of a large crowd that is not yet under much surveillance, with people around you that you trust, and to move in the body of the crowd to a meeting point with your fellows in the bloc. Wearing layers is important here, too: if you can start in a disposable outermost layer that makes you look like a civilian or liberal activist (if perhaps one overdressed for the weather), masking up will simply mean discarding it and simultaneously pulling up your mask. At an action in which you have the benefit of surprise, you can always pick a safe, quiet place near your convergence point and mask up there.

You can carry umbrellas to make it more difficult for cameras or overhead observers to monitor the activities of your group.

# RedManXP

Defensive Tactics Training Suit



FOR OUR  
LATEST  
DEALS & OFFERS  
visit  
NITON999  
COM

### XP INSTRUCTOR SUIT

- Its mobility and form-fitting design enable you to engage in a wide range of training activities, with the confidence of being covered by the industry's premiere blunt trauma training gear.
  - Gaps are minimized and coverage is maximized - with the right training, knowledge and gear, you can take strike after strike.
  - What's more, if you need to change instructors, you can do so easily and provide a clean, dry, disinfected suit in 5 minutes. The easy Velcro® strapping design makes it a one-person operation. RedMan is the only gear that offers safety from blunt trauma and from bloodborne (HIV/AIDS, Hepatitis) and other pathogens.
- Code RMXP1 XP4 Body L/XL Head L  
Code RMXP1 XP5 Body L/XL Head XL

XP INSTRUCTOR BODY GUARD		
SIZE	HEIGHT	WEIGHT
S/M	UP TO 5'10"	UP TO 180lbs
L/XL	OVER 5'10"	OVER 180lbs

**RedMan TRAINING**  
SPECIALIST SIMULATION TRAINING COURSES  
TURN TO NITON TRAINING SECTION

### WHY REDMAN?

RedMan is the only gear on the market today that is quickly and easily cleaned, spray disinfected, and dried after each user. No one wants to share sweat, blood, and disease-causing micro-organisms. Used according to instructions, RedMan keeps officers safer from blunt trauma and from bloodborne (HIV/AIDS, Hepatitis) and other pathogens. Ask the competition if they can do that!



XP STUDENT BODY GUARD		
SIZE	HEIGHT	WEIGHT
S/M	UP TO 5'10"	UP TO 180lbs
L/XL	OVER 5'10"	OVER 180lbs

XP STUDENT HEADGEAR BY CIRCUMFERENCE	
MEDIUM	21"-22"
LARGE	22.5"-23"
X LARGE	23.5"-24"

### XP STUDENT SUIT

- The Student Suit is an important part of the total simulation program, enabling officers to do more than just walk through light contact scenarios. Officers can participate in safe, reality-based training, improving their defensive tactics skills to take back on duty.
  - The fit and comfort of the Student Suit allows students to get the most out of their training experience. Trauma protection is immediately evident - with maximum protection to the vital areas of the head, and chest. The elbows and knees are flexible, for ease of movement.
  - Students can also share equipment because it's easy to put on and take off in just minutes using Velcro® strapping. It can be cleaned, spray-disinfected and dried for the next person in minutes - plus the closed cell dipped polyethylene foam creates a barrier that provides safety from blunt trauma and from bloodborne (HIV/AIDS, Hepatitis) and other pathogens. Strapping design makes it a one-person operation.
- Code RMXP2 XP4 Body L/XL Head L  
Code RMXP2 XP5 Body L/XL Head XL

CALL FOR LATEST PRICES

# FORE-ARM GUARDS

FUKY R. BATONS

Sick of getting wailed over the head with police batons while engaging in your favorite pastime? These fore-arm guards may just help you out....

They're pretty simple to make, materials are cheap (or free if stolen or dumpstered), they go through metal detectors, and depending on how you put them together they can be extremely low profile.

## What you need:

**Fabric:** Whatever color/type is your favorite, but you should be able to sew through it easily, and it should be able to take a beating without disintegrating. You'll need a yard or two of a normal bolt of fabric.

**Sewing supplies** (needle, thread, pins, scissors, tape measure)

2 yards of nylon or cotton strap material (1" wide)

4 strap fasteners (like on the straps on backpacks)—they usually come in packs of two

3" diameter PVC pipe—this can be picked up at your local hardware store—they may think you're making a potato cannon, but they should let you pick some up. You'll need somewhere between two and three feet

**PVC** A cross cut saw (normal wood saw) without massive teeth—this is for cutting the

Sandpaper (fairly fine grit) or a sharp utility knife

**Foam:** Open cell foam can be bought at fabric/craft stores. 1/2" foam is enough to cut the pain of a hard crack across the arm to nearly nothing. For people with smaller arms, however, this can be rather cumbersome and high-profile—1/4" might be better in that case. Even with no foam, the guards will still prevent broken arms and severe bruises, but foam makes the whole experience far more comfortable.

First thing to do is saw the PVC into the correct length. Measure from your elbow to your wrist and subtract two inches. This is the length for your two pieces. The cutting is best done outside, as the smell created isn't real great. After sawing your PVC into two pieces, each pipe piece needs to be split into six pieces (like splitting wood—you don't end up with six cylinders, you end up with six strips). The easiest way to split it in six is to saw across the entire piece (so as to make two cuts) at evenly spaced intervals. It doesn't matter too much if they aren't all exactly the same width, mine sure as hell weren't. Also, six is just the number I used.... I wouldn't recommend any less, but more might be okay. This is a fairly physically intense process...so take your time and wear work gloves... Keep the two sets of pieces separate, as mixing the 12 pieces might give you some weird looking (though probably still useful) guards. After sawing, the pieces will be pretty rough so sand them down or smooth the edges with the utility knife. They don't have to be real smooth, but remove the sharp edges.

Next comes the fabric. The first piece you'll need to cut is as such: The width should be the length from elbow to wrist plus four inches. The length should be the circumference (distance around) your arm at the fattest part near the elbow, plus 6-10 inches. As these vary widely for different-shaped people, some will find that you won't use all the PVC, while others might need to cut some extra slats to get all the way around the arm... The second piece of fabric you need is the same width as the PVC is long and the same length as the first piece of fabric. The rest of the directions will assume that the pieces are longer than they are wide, so if that isn't the case, then switch it around in your head.

Hem the sides of both pieces (fold the edge over and sew it down so that the fabric doesn't unravel), then lay the second piece on top of the first, centered with regards to width, and sew them together along one of the shorter edges. This is now the top.

Slide a piece of PVC between the two pieces of fabric and against the top seam. Pin the fabric layers together to create a sort of sleeve for the PVC slat. Make it as tight as you can, then sew a seam along the pins to make the sleeve permanent. Repeat this with each piece of PVC until you either run out of fabric or run out of PVC. You should now be able to wrap the guard around your arm for a fairly close fit.

Next wrap the sides of piece 1 (as in top, sides, and bottom) around the end of the semi-exposed PVC. Sew these down to piece #2 to keep the PVC from sliding out of the sleeves. Sew the straps on as you like, but make sure that you can pull them tight (as in make sure that the buckle and the beginning of the strap don't hit other when you cinch in)

Cut a piece of foam that will entirely wrap around your forearm, and you have the option of sewing it to the guard or just leaving it free (I just left mine free. Less hassle that way and when it counts the foam should be cinched tight to your arm and not going anywhere).

These took me about two hours per guard, sewing everything by hand.

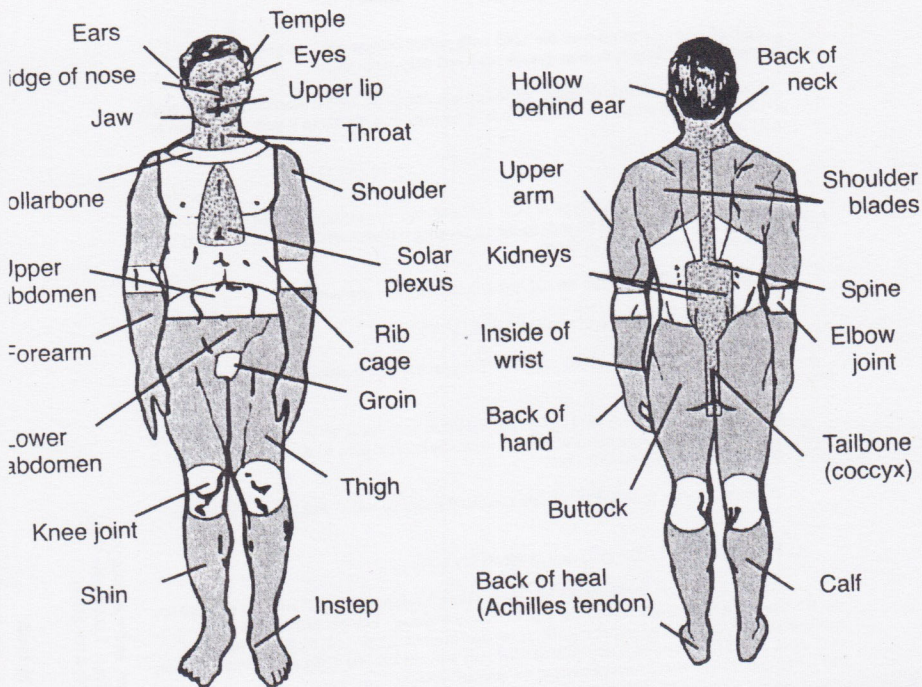

**Green (lowest level of trauma)**

**Primary-target areas:**

**Reasoning:** Minimum level of resultant trauma. Injury tends to be temporary rather than permanent; however, exceptions can occur when applying as a restraint technique.

**NOTE:** When performing a block with a riot baton, the whole body is a green area, except for the head, neck, and spine.

**Yellow (moderate level of trauma)**

**Secondary-target areas:**

**Reasoning:** Moderate level of resultant trauma. Injury tends to be more permanent, but may also be temporary when applying as a striking technique.

**Red (deadly force)**  
**Final-target areas:**

**Reasoning:** Highest level of resultant trauma. Injury tends to be permanent rather than temporary and may include unconsciousness, serious bodily injury, shock, or death.

Figure 4-4. Escalation of Trauma Chart

## guide to radical self-defense: how to make padding and armor for street actions

Here are some simple ways to make dependable, DIY armor and padding from readily available components. As armorer for the now-defunct NYC Ya Basta! Collective 2000-2002, I can say these designs were tested and found to work best on the streets.

### LIGHT WEIGHT, POLICE BATON PROOF FOREARM GUARDS

- 1) Go to a sporting goods store or second-hand store that has/sells soccer protective equipment.
- 2) Secure 1 pair of hard plastic shin guard sock inserts and 1 pair of hard or soft stirrup style shin guards.
- 3) Superglue or epoxy the hard inserts onto the front shin pads of the stirrup shin guards, adding protection.
- 4) Let dry.
- 5) For use, wear as forearm pads with the hard plastic guards positioned on the exterior of the forearm and the stirrup loop placed between the thumb and index finger. These fit well under hoodie sleeves and may be worn with gloves for added protection/clandestinity.

### \*\*\*\*\* FIVE LITTLE BLACK STARS \*\*\*\*\*

Very light weight, very concealable, very sturdy and can definitely withstand a full force baton whack.

### ALTERNATE FOREARM PROTECTION

- 1) Find hard, thick (at least 1/2 inch) shipping cardboard tubing. Saw into piece approx. 1 foot in length or the length of your forearm. Saw down the middle to create two half pipes.
- 2) Find sheets of small bubble wrap or carpet padding. Line the inside curve of cardboard half-pipe with bubble wrap/carpet padding. Duct tape together.
- 3) For use, duct tape the whole thing onto your forearm.

### \*\*\* THREE LITTLE BLACK STARS \*\*\*

If you are in serious need, these are OK, but are very bulky and not concealable. Good if you travel safely in large groups.

### DIY SHOULDER PADS

- 1) This is the classic European Ya Basta/Tute Bianchi style shoulder padding... first, find a large sheet or sheets of cardboard, styrofoam, carpet padding and duct tape.
- 2) Cut cardboard in a pattern that fits over your head and shoulders in slices. Lay down carpet padding as a lining on inside of pattern, like a sandwich. Put squares of styrofoam into the sandwich over shoulder areas. Sandwich together. Duct tape.
- 3) For use, duct tape it to yourself!

### \* ONE LITTLE BLACK STAR \*

I don't know what Luca Casarini was fucking thinking... This was so bulky and cumbersome, most people ditched it in favor of other padding. It often fell apart... when police whacked at it.

### 2 LITER SODA BOTTLE CHEST PLATE

- 1) Get three empty 2 liter soda bottles. Make sure caps are tight and air is trapped inside nicely. Get cardboard and carpet padding.
- 2) Make a 2 liter soda bottle sandwich with padding and c-board.
- 3) Duct tape together!
- 4) For use, duct tape it to yourself!

### \*\*\* THREE LITTLE BLACK STARS \*\*\*

Amazing, near perfect protection, but over a very limited area of the body and incredibly cumbersome. Did I mention it is free???

### LACROSSE PAD STOMACH / CHEST PLATE

- 1) Find pair of lacrosse kidney/side torso pads.
- 2) Position one above the other so that the bottom edge of the top pad overlaps the top edge of the bottom pad slightly.
- 3) Sew the straps together so that they form one piece that fits vertically the front of your torso.
- 4) Sew additional straps onto the sides of both lacrosse pad, and additional ones at the top edge of the top pad, so that the whole double pad can be strapped onto your body. Can be worn under clothes.

### \*\*\*\* FOUR LITTLE BLACK STARS \*\*\*\*

These are good if you can find them. Even then, they are only slightly concealable and often slip out of position if the straps are not tight enough to hold in place, but stand up very well to repeated police baton lunges.

### TOILET SEAT BREAST PLATE

- 1) I shit you not, get an old (or new) toilet seat.
- 2) Duct tape it shut.
- 3) Add carpet padding to the bottom of the seat until it can be comfortably strapped to your stomach/chest.
- 4) For use, duct tape it to yourself or hang it around your neck (duct tape is suggested with or without neck strap).
- 5) Can be worn under clothes.

### \*\*\* THREE LITTLE BLACK STARS \*\*\*

This held up surprisingly well, was very lightweight and the hard plastic shell was very defensive. A bit odd to have a toilet seat strapped around you, there were some problems with keeping it in place and uncomfortable to move in. All around positive.

### TRAFFIC BARREL TOWER SHIELDS

- 1) Find orange traffic barrels. (Garbage cans/lids have been used, but are not suggested - too flimsy.)
- 2) Saw traffic barrel down the middle to create two half-pipes.
- 3) Get two handles of some sort, like trowel handles, but other stuff will do, and screw them into place in the curve of the shield where it is most comfortable to hold them.
- 4) Spray paint them however and you are ready.
- 5) For another tactic, drill holes in the right and left side of each shield. Loop metal carabiners through holes. For a shield wall tactic, hook carabiners from one shield to those of the one right next to it; the shields are now connected and provide a sturdier line of defence. (Requires lots of team work though.)

### \*\*\*\* FOUR LITTLE BLACK STARS \*\*\*\*

These work really well, but only when used by an entire affinity group who knows what they are doing. Can be adapted in other ways to be used as street propaganda as well, by depicting images on front of shields. Easy to acquire, easy to make, hard to conceal. This tactic has never been successfully used in NYC, but has in DC.

### HELMETS

The use of makeshift or DIY helmets is extremely discouraged... those would only give you a false sense of noggin protection. Use only, in order from best to worst: full or open face motorcycle or police riot/swat helmets with or without visors, off-road bicycle helmets, other bicycle helmets, construction hard hats.

LBA Ballistic Shields are produced from the latest state-of-the-art composite armour technology. All products offer the highest level of ballistic protection, while retaining as much mobility as is practical.

LBA produces 4 standard flat shields which meet current police operational requirements. Designed to provide the maximum protection while being easily carried and deployed.

### BALLISTIC CLIPBOARD (BC)

Introduced for use by 'road block' officers in Northern Ireland, the Ballistic Clipboard enjoys continued international success. It appears to be a standard issue clipboard but the NIJ Level IIIA armour level has saved many lives in the past 22 years.

The LBA clipboard also provides the best possible protection to police officers involved in traffic operations. The unit is fitted with a rigid handle.

Max weight: 1.35kg Size: 390 x 310mm



### MINI SHIELD

This unit provides the same high level of protection as all LBA shields. Designed to protect the full upper body area. The mini shield can be comfortably carried on one arm.

Max weight: 2.60kg  
Height: 0.56m  
Width: 0.51m

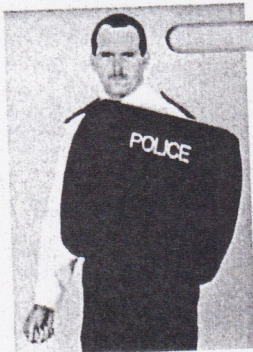

# BALLISTIC FLAT SHIELDS

### SIEGE SHIELD

A full body length shield fitted with fully adjustable carrying handles which provides officers with the best possible protection in siege, hostage or riot control situations. The shield is fitted with an anti ballistic window. An articulated centre hinge enables the unit to be folded and stored easily in the boot of a police vehicle.

Max weight: 14.00kg  
Height 1.83m extended,  
1.15m folded  
Width 0.58m

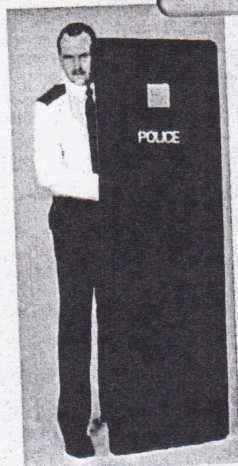

### MIDI SHIELD

A half body length shield with all the advantages of the full length unit including the anti ballistic window. The midi shield is excellent in restricted space operations.

Max weight: 9.50kg  
Height 1.22m  
Width: 0.51m



### SIZES AVAILABLE FOR CURVED SHIELDS

Size	Height	Width	Ballistic Window
Small	660mm (26")	565mm (22")	N/A
Medium	1000mm (39")	565mm (22")	100mm x 250mm (4" x 10")
Large	1300mm (51")	565mm (22")	100mm x 250mm (4" x 10")

### SIZES AVAILABLE FOR FLAT SHIELDS

Size	Height	Width	Ballistic Window
Mini	560mm (22")	510mm (20")	N/A
Midi	1220mm (48")	510mm (20")	100mm x 100mm (4" x 4")
Siege	1830mm (71")	580mm (23")	100mm x 100mm (4" x 4")

## Shield varieties, their construction and other equipment

### Garbage can/barrel shields:

The easiest shield to make is often one that is mostly pre-made for you. Found street items can often work wonderfully making construction quick and easy. Plastic garbage cans are the easiest with lids turning into instant shields and the cans themselves requiring little more than being cut in half. Orange construction barrels are a little bit more difficult to obtain, but can similarly be used - however they tend to be much more rounded and hence difficult to grip in a one-armed style.



### Construction:

With a can lid, you should be all set. That is unless you don't want the awkward to use handle, which is not optimal for protecting yourself or advancing, but will do fine if you aren't particular. If you desire a better grip, follow the above instructions. Furthermore, keep in mind that the handle is on the opposite side of what you might prefer. It should be attached so that the concave rounded side is what points outward.

Ideal for tower shields, the body portion of a plastic trash can be used for two or three shields depending on the size of the can and the desired width. Larger, industrial trash containers or barrels tend to be taller and will cover more area. With a saw, remove the bottom of the can and any handles on the side. Then cut the can into the desired portions. Size it up against your own body to find the desired width. Since the can is rounded, applying one-armed handles on the inside of the shield will be a little bit trickier. While it works fine in that manner, trashcan shields are also perfect for the two-handed grip style. If you are using it in this manner and plan on being in the front line of a Tortoise formation, consider using a hot knife to cut a small slit a few inches from the top to peer through.

### Inflatable shields:

**Tip:** Do not forget for all shields about the need to place foam or another material along the part of the shield which you arm will reside behind. This should run from your knuckles at the grip down to your elbow on a one-armed shield.

Quick to construct, easy to transport, inconspicuous and adding an extra bounce, inflatable shields are a very clever variant. On the opposite extreme of an imposing shield wall, using inflatable shields gives the disarming appearance that the police are busting up a beach party.

There are two main variants of inflatable shields - rounded life-saver style and the tall, flat pool raft. The life-saver style is basically a round shield with some added thickness, whereas the pool raft can provide full body protection, although they tend not to be very thick.

Given what you will find, there are two variants of the life-saver style. The slightly smaller and lightweight option is to purchase a small, inflatable personal pool flotation device. These are made from plastic and are easier to puncture plus have thinner walls, but are much easier to wield. Doubling up of two of these light tubes is also an option. The heavy and strong choice are large inner-tubes, often used for sitting in. These are thick, bouncy but quite heavy. Given



Innertube shields on the move in Cancun, Mexico.



## Objective

Gain new understanding and skills relative to the Riot Shield as deployed by an officer as part of a team in situations of mass demonstrations, riots, and gatherings of hostile crowds.

## Background

The Riot Shield is typically viewed as a passive defense tool. While it can serve in such capacity, it is important to examine and study the work of individual officer, small cell (2 or 3 officers) and large riot control/suppression team deploying riot shields in given situation in more proactive manner.

The basic riot shield offers an array of possibilities to be deployed in a proactive manner against the aggressive elements in hostile crowd/riot situations. In many cases the need to deploy impact weapons (batons, sticks, etc.) to defend against, control and subdue the subjects will be minimized once the use of the shield is mastered.

This mastery requires that an officer remains relatively calm, maintains situational awareness and thinks in situations that often could be extremely chaotic and stressful.

This approach has number of benefits.

- Quick, efficient and less visually aggressive apprehension/neutralization of the subjects
- less use of impact tools that potentially can cause severe trauma/death of the subject
- lower risk to the officers

The natural consequence of this is the reduction of liability and better management of public relations issues associated with the modern LE environment.

While visually less aggressive, work with the riot shield can be escalated by trained operator in situations requiring such course of action. Through understanding of the basic principles involved, knowledge of biomechanics and use of specific methods taught, the operator gains ability to work with the shield throughout the spectrum of the force continuum.

This ability extended to all officers of the riot control team in combination with specific methods of small team work (2 and 3 man cells), large team tactics, solid management by commanding officers and effective communications will make riot control/suppression operations much more efficient and effective.

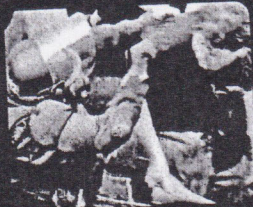

their weight, they make considerably better options as a two-handed shield, providing for strong shoving action.

The pool raft variant provides for a sort of tower shield, quite possibly one that is larger than your own body. If available, purchase rafts of the smallest variety, although due to their lightweight, an overly tall raft should not be too obtrusive. Because such cheap pool rafts are rather thin and not very rigid, it is recommended that you try to affix two of them together. Thicker, heavier and much sturdier rafts also exist for about four times the cost of a cheap one.

#### Construction:

Inflatable shields have the enormous advantage of being quick to construct just before a demonstration kicks off. With hard effort, it should take no more than 30 minutes to construct any of the variants in any style. Remember that while uninflated rafts are easy to explain to inquisitive officers, some of the other materials needed might not be.

Option 1: The first option simply requires an awful lot of tape. Packaging tape or duct tape will work just fine. They key here is to strengthen the center area of the shield with tape so that it can sustain blows without puncturing. Of course this is especially critical with life-saver rafts that have an open center. Second of all, the tape is then used to fashion handles. This is where you decide if your shield will be a one- or two-handed variety. Follow the patterns for determining handle position and angle as universally described above. The tape is wrapped around and given slack in these areas and the slack portion is wadded so as to provide a thin grip. Make several passes to ensure strength. For raft shields that would require excessive amounts of tape when wrapped vertically, make the handles from small strips, place them in position and then secure them down at the top and bottom of the handles by wrapping tape horizontally.

Option 2: Option two utilizes some sort of thick plastic wrap such as a tarp, or failing that, a strong bedsheet or other large fabric. The intention here is to substitute the massive amounts of tape in option one with a basic covering that can sustain blows while maintaining the bounce effect of the rafts. Either a small section of the tarp or fabric can be cut out to cover the needed area, or a much larger amount can be used to wrap the entire shield. Then use strong tape to tightly secure the material and make sure it is taut enough to maintain the bounce factor. Be aware that packaging tape does not stick well to fabrics and that duct tape should be used in this case. Finally, fashion handles in the same manner as in option one.

#### Plexiglass shields

Plexiglass is a highly versatile material since it can be cut and manipulated, and is fairly lightweight. Home improvement stores sell plexiglass in a variety of sizes. One could cut anything from a small one-armed shield, to a massive multi-person shield wall. The only draw back is the lack of flexibility means that not only are rounded shapes near impossible, but that the material can snap easily. In order to sustain baton or projectile blows the shield would have to be at least a 1/2" in thickness. If the material does not come that way, it can



Two giant plexiglass shields envelop police in Italy, March 17, 2001.

be layered and glued with a mixed epoxy, super glue or glue gun.

Some protesters that have seen this shield employed maintain that it also has a disarming affect on police psychology. The police officers who are unable to see an individual in front of them seem to lose their sense of personal rage against individuals.

#### Construction:

Plexiglass can be roughly cut with a hand-saw, but a band saw is much preferred. If you lack an electric saw, consider drilling multiple holes in a line and snapping off the excess. Hopefully you can acquire the size you want right away though.

A good idea for added reinforcement, especially if your shield is extremely large, is to affix planks of wood along the oblong sides. A full frame of wood will help that much more. Just remember that wood adds a great deal more weight. Wood can be affixed either by

## RIOT SHIELD

4-3. In the hands of a properly trained soldier, the riot shield has proven to be the first line of defense for a formation. The riot shield may be used as an offensive weapon when in contact with an aggressive crowd.

4-4. The riot shield may be held with one arm. It is secured to the weak side arm with a self-sticking strap system and a handle. This system is designed to make the riot shield an extension of the soldier's arm. The riot shield is held at a slightly inward angle. This allows for debris thrown at the soldier to fall harmlessly to the ground (see *Figure 4-1*).

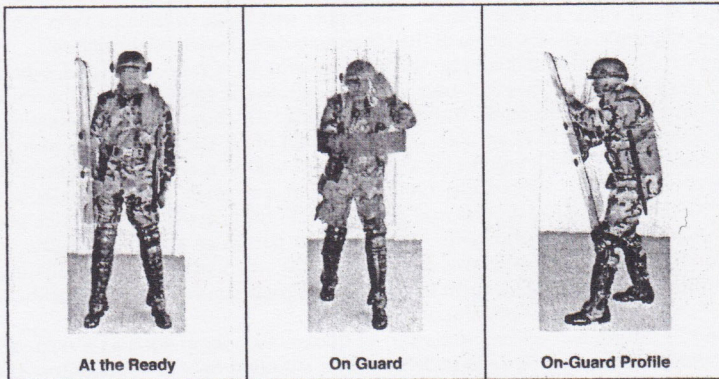

Figure 4-1. Riot Shield Positions

## DEFENSE

4-7. The first line of defense for the formation is the riot shield. It is designed to withstand strikes from objects thrown by the crowd. In addition to protecting the riot shield bearer, it also protects other members of the formation from thrown objects.

## RETENTION

4-8. When the control force is in contact with the crowd, the crowd will attempt to strip the riot shield from the bearer. When a subject grabs the top of the riot shield (see *Figure 4-2*), the riot shield holder slaps the riot shield with his strong hand near the subject's hands and gives the following commands (while continuing to slap the riot shield until the subject releases it):

- "Get back."
- "Get away."
- "Stop."



Figure 4-2. Riot Shield Retention Technique (Top Attempt)

strong wood glue, or more easily, screws or bolts.

For the handles, remember that plexiglass is a hard surface and you will want padding under the place where your arm will go. Leather straps or ropes can be easily affixed by tying them through holes made with a drill. Again, wood helps to add stability on the points where your handles connect to the plexiglass.

#### *Improvised backpack shield:*

In a pinch, simply placing a flat piece of plywood, layered cardboard or tagboard in an otherwise empty backpack can make a small sized two-handed shield. The idea is to maximize the surface area, which should garner you something approximating 15" x 12" given an average backpack size. You will have to remember to cut the board(s) down to a size that fits before the day of action.

The added advantage of this is its complete concealability. Apart from the rough corners, it would be hard to judge what your backpack is truly going to be used for to an outside observer. The downsides are pretty clear though. Not only is the shield of small size, the straps are too large to be very practical to use in a one-handed manner. One way to remedy this is to use a piece of soft rope or another non-chaffing material and wrap your forearm in place on the backpack strap. Otherwise, use the backpack in a two-handed manner.

#### *Banner shields:*

Banner shields are group shields which are used to maintain marching cohesion and can be the frontline for a push forward if need be. Otherwise, they serve as fantastic med-age boards.

A banner shield requires only ample cloth or a tarp and hard plastic tubing to maintain to provide the skeleton. The banner should be wide enough to go from chin to ankle. The banner is wrapped along top and bottom and then stapled or taped over the tubes. Then to prevent the lower portion from swining into shins, epoxy other tubes or cut wood to give it a stronger frame. This is all optional however, as only the top bar is really critical, but consider a rigid full frame and using tarp if you expect projectiles to be fired.

The length of the banner should be no more than half of a street length. This allows a hinge in the middle of the formation to create a wedge if need be. Banner shields carried on the sides encourage tight cohesion and can be swung up front if they are needed. Remember though that such a hinge in the middle also makes it the weakest point and emphasis should be placed on having people crowding behind to cover that.

#### *Other shield concepts:*

**Tip:** Is your found-object shield too small? A garbage can tower shield might not fully extend down your legs - a choice place for police to fire and bounce projectiles at. A small one or two foot extension of plexiglass can be screwed into the bottom of your shield. To make sure that the plexiglass doesn't snap at first impact, consider bolting pieces of 2x2 wood down the sides for added durability.

All in all, most anything can easily become a shield so long as you adapt it to your liking. There are some materials you would wish to avoid, such as wood due to its weight. Also metal, specifically lightweight aluminum seems like an immediate choice, it is expensive, very difficult to work with and can be painful to the bearer should it wind up jabbed back into your face.

Yet anything you think that will be lightweight, firm and easy to affix handles to will work fine. An old thumbtack board or plastic tabletop you might find in the trash would do fine. Shield construction is all just a matter of the time you are willing to put in it, or dumb luck as per what you might find.

# NIJ STANDARD FOR RIOT HELMETS AND FACE SHIELDS

## 1. PURPOSE AND SCOPE

The purpose of this standard is to establish requirements and methods of test for helmets and face shields to be worn by law enforcement officers during civil disturbances, riots, or other situations that pose a threat of injury from blows to the head. This standard is a revision of and supersedes NIJ Standard-0104.01 dated August 1980. This revision of the standard changes the impact attenuation requirement, deletes the requirement for wet testing of helmets, modifies the requirement and test method for peripheral vision limits, and clarifies test methods and test equipment requirements. The scope of the standard is limited to riot helmets and face shields. It should be noted that they are not designed to offer protection against gunfire. Ballistic helmets and crash helmets are covered by other NIJ standards [1,2].\*

## 2. CLASSIFICATION

### 2.1 Face Shields

Face shields covered by this standard are of one class.

### 2.2 Riot Helmets

Riot helmets covered by this standard are of one class.

## 3. DEFINITIONS

### 3.1 Basic Plane

The plane through the centers of the external ear openings and the lower edges of the eye sockets (see fig. 1).

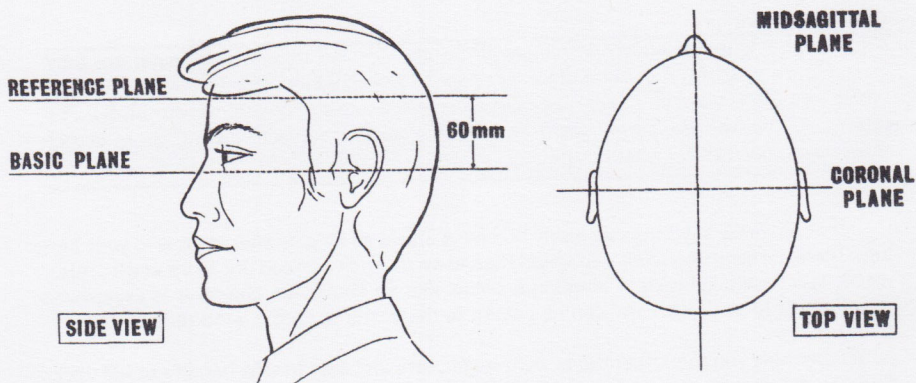

FIGURE 1. Head planes.

## Helmets:

Helmets are a critical part of any defensive tactic, be it a shield wall or a simple and open direct action where attack is a major risk. As police forces have regularly demonstrated that they do not follow their own guidelines of avoiding blows to the head, a helmet is an important piece of protection.

Unfortunately a helmet is too tricky a piece of equipment to make appropriately, that you will have to acquire something pre-made.

The most basic helmet with the minimal amount of protection is a construction hat. These can usually most simply be found in a toy store, provided they are large enough. Wadded newspaper inside will help soften blows. The next easiest helmets to acquire are bike or motorcycle ones. Thrift stores should have a selection of these, but otherwise they are a little expensive.

The ultimate option, although quite conspicuous in transporting are military helmets. Modern helmets are made from Kevlar meant to stop a bullet. These are extremely costly and not necessary. What can be acquired quite cheaply are surplus steel helmets, often of foreign make, that are sold in military surplus catalogs. Do a web search for military surplus or militaria, or otherwise ask a local army surplus store for catalogs.



Helmets, cardboard and life-jackets make up the body armor in this Italian march.

For personal protection a solid helmet is probably the most important thing one can bring to a demonstration after a gas mask.

- 1. Helmet.** A helmet is worn to protect your head from projectiles & batons. Helmet can be military surplus, motorcycle, mountain climbing, or hockey. Other than military helmet, all civilian versions should be spray-painted matt black. If gas masks are to be worn, helmets must not have face or mouth guards that will prohibit use of gas masks.

## 1.2 Coronal Plane

The plane, perpendicular to the basic and midsagittal planes, which passes through the centers of the external ear openings (see fig. 1).

## 3.3 Edging

The edge, rim, or rim trim around a helmet.

## 3.4 Headform

A test device that simulates the configuration of the human head.

## 3.5 Impact Attenuation

A measure of the extent to which impact energy delivered to a helmeted head is reduced by the helmet intervention. For the purpose of this standard, impact attenuation is evaluated through the measurement of the peak acceleration of a headform secured within a helmet when subjected to an impact energy of 108 J (80 lbf-ft) at a velocity of 6.6 m/s (21.7 ft/s). The peak acceleration of the headform decreases with increasing impact attenuation.

## 3.6 Midsagittal Plane

The plane, perpendicular to the basic and coronal planes, which symmetrically bisects the head (see fig. 1).

## 3.7 Primary Visual Area

The face shield area that is bounded at the top by a line 12 mm inside the top edge of the face shield, is 85 mm from top to bottom, and is bounded at the sides by the arcs of a circle of 90 mm radius with its center located at the intersection of the midsagittal plane, the front surface of the face shield, and the plane that is 15 mm above and parallel to the basic plane (see fig. 2).

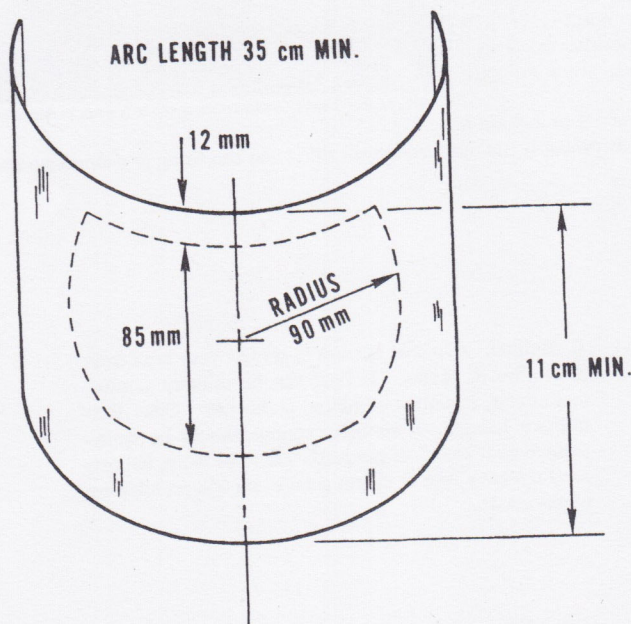
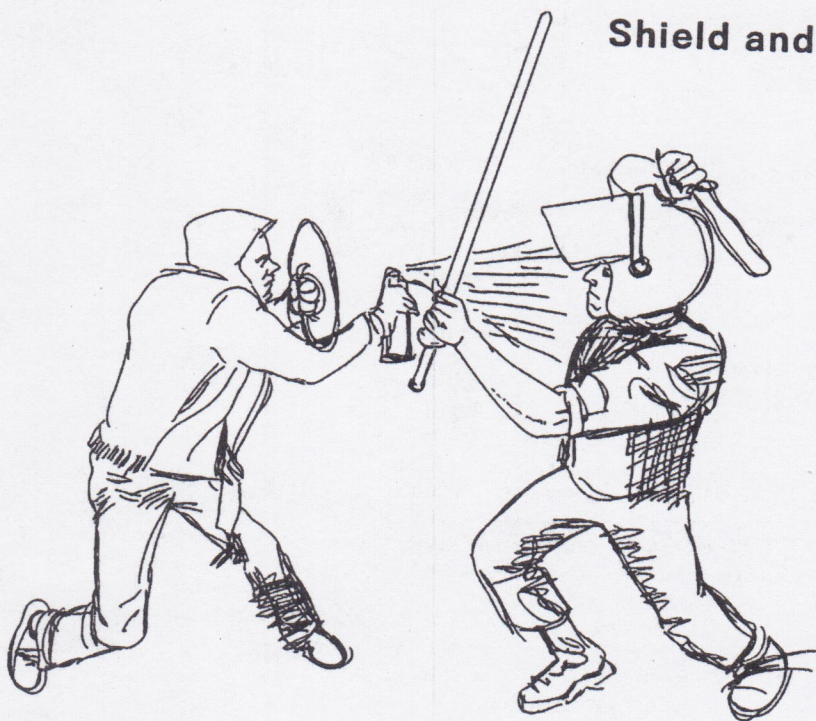

FIGURE 2. Face shield configuration. The primary visual area is outlined with dashed lines.

## Shield and Spray



**HOLD YOUR GROUND, EGYPTIAN!**  
Block the truncheon with your shield  
as you're spraying them in the face.



## Advantage® 1000 Riot Control Agent Gas Mask

- NIOSH-approved for protection against CN and CS tear gas.
- One-piece polyurethane lens provides wide, unobstructed field - of - vision and extended wearing comfort.
- Dual-canister mount eases weapon sighting, using either eye.
- Effective against OC tear gas.
- NIOSH approved for protection against many Meth-Lab hazards.

MSA's Advantage 1000 Riot Control Agent (RCA) Gas Mask is specifically designed for law enforcement and homeland security applications. The gas mask is NIOSH-approved (No.TC-14G-0235) for protection against chloroacetphenone (CN), chlorobenzylidene (CS), P100 particulate efficiency level, and particulates. The gas mask is effective against, but does not have NIOSH approval for oleoresin capsicum, the "active" ingredient of OC Tear Gas. The Advantage 1000 RCA Canister provides up to eight hours service time against CN, CS, and OC agents.

The Advantage 1000 Riot Control Gas Mask features a clean, simplified respirator design with a single low-profile canister. It delivers high performance, customized fit, comfort, economy and user acceptance. The super-soft Hycar facepiece (based on a proven design developed for the U.S. Armed Forces) is up to 40% lighter than conventional full-face respirators.

Molded of black Hycar - a specially formulated combination of natural rubber and synthetic materials - the Advantage 1000 Riot Control Agent Gas Mask resists chemical attack and temperature extremes, can withstand rugged daily use and still give a snug, comfortable fit. The fully elastic, 6-point head harness dons, doffs, and adjusts easily, with no hair pulling.

A flexible, one-piece polyurethane lens bonded to the facepiece eliminates the need for a rigid lens and lens ring that can cause uncomfortable pressure points. Wrap-around lens design provides excellent peripheral vision. Low profile design minimizes dead-air space and permits easy integration with most visored police helmets.

The facepiece has canister inlet ports on either side of the facepiece. The canister position (bayonet mount) can be switched to enable the user to sight a weapon from either shoulder.

Standard equipment includes a speaking diaphragm for clear, short-range communications, or add MSA's optional ESP II Communication System. The facepiece also features a nosecup to reduce lens fogging in low temperatures or high humidity conditions.



Swing the bayonet mount canister on either the left or right inlet port to enable weapon sighting with either eye.

## HOW TO MAKE A HOMEMADE TEAR-GAS MASK



Transparent 2 Litre Soda Bottle

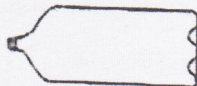

Cut as follows

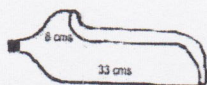

Glue a strip of rubber foam on the inside edge of the bottle

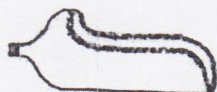

Glue and sew a strip of cloth over the foam rubber



put a clinical mouth-cover in the neck of the bottle and elastic to secure it to your head

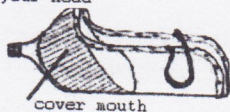

Carry a bottle of vinegar to soak the mouth cover before putting on the mask.

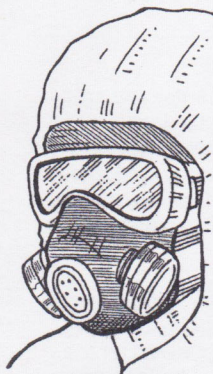

Eye Goggles  
w/ Filter Mask



BACK-UP BANDANA  
Soaked in Vinegar &  
Carried in Zip-Loc Bag

### A FEW HOT TIPS ABOUT GAS MASKS, & OTHER GEAR

The best protection against chemical weapons is a gas mask. Prices range from \$10-50. Any kind of mask should be tried on and sized before you're in the streets fumbling with unfamiliar straps. When paired with goggles, respirators make an excellent alternative to gas masks. It is necessary to do some homework beforehand and find goggles that are shatterproof, don't fog up, and that fit tightly on your face with the respirator. Respirators can be purchased at safety supply or welding supply stores. Ask for filters for particulates and organic chemicals and tell the clerk what you're filtering to double check. Costs range between \$18-24.

A bandanna soaked in water or vinegar and tied tightly around the nose and mouth is a last resort. It is far better than nothing, but remember that it is merely a barrier and not a filter and so won't do much for long-term protection. You can keep it soaking in a plastic bag until ready to use. Bring several, as multiple uses will render a bandanna as gassy as the air around you.

For protecting your eyes, swim goggles work well as they have a tight seal. Shatter-resistance is very important (a rubber bullet to the eye can be disastrous). Most goggles have air holes to prevent fogging—fill these with epoxy. Covering these holes with duct tape can work in a pinch against an initial attack, though not for long term protection. Try them on with your respirator or bandanna to ensure that they are compatible and that both will provide a tight seal.



## V. RESPIRATOR SELECTION

Agencies shall maintain records on the type of equipment provided to employees and under what circumstances the equipment is to be used.

### Recommended Equipment Use Chart

Respirator Use	Respirator Type	Manufacturer/model
Escape from chem/bio/nuclear incidents	CBRN approved escape hood (not yet available)	
Perimeter hazmat incidents with specific industrial chemicals	Full facepiece (NIOSH approval TC 14G) combination cartridge or as specified by the hazmat incident commander	
Perimeter chem/bio/nuclear incident	Full facepiece (gas mask) with CBRN approval (not yet available)	
Perimeter crowd control (CS or CN tear gas)	Full facepiece (gas mask), TC 14G chloracetophenone cartridge or canister (combination organic vapor/particulate)	
Activation within crowd control area (CS or CN tear gas)	Full facepiece (gas mask) TC 14G chloracetophenone cartridge or canister (combination organic vapor/particulate)	
Respiratory illness (TB, SARS, etc)	N-95 particulate respirator TC - 84A	

**Entry:** Respirators issued under this program shall not be used to enter any area that is designated as the exclusion ("hot" or "red") zone, or the contaminant reduction ("warm" or "yellow") zone of a hazardous materials incident. They also should not be used to enter any areas that are known or suspected to be oxygen deficient, or that contain concentrations of hazardous substances that are unknown or are immediately dangerous to life or health (IDLH). Respirator use shall not conflict with the agency's emergency response plan.

**Continuous duty:** For continuous duty in maintaining the perimeter of hazardous materials or crowd control incidents, approved gas masks and other air-purifying respirators shall be used. Respirators shall be selected that are approved for the contaminants that are believed to be present, and wearers shall not be located in atmospheres in which concentrations exceed the protection factor of the respirator. The program administrator or incident commander shall determine a cartridge change schedule.

**Breakthrough:** If an officer detects breakthrough, the officer shall exit the area immediately, or as soon as safety conditions permit, remove the respirator and perform decontamination procedures. Breakthrough shall be reported to the incident commander or officer in charge. The incident commander or officer in charge shall re-evaluate potential exposures and determine whether it is necessary to redefine the incident perimeter.

### Military Filters:

"NATO" C2 (Standard) or C2A2 (Chromium-free): Nuclear, Biological, Chemical ("NBC") & Riot Agent. 40mm (NATO) threading: interchangeable with all NATO-country masks, masks from many other nations (Israel), and some commercial masks. These filters contain a near-P100 quality filter against riot agents and biological agents, as well as zinc-catalyst impregnated activated charcoal (ASZ) to neutralize CW agents, as well as many other organic chemicals. They sometimes also contain additional agents to neutralize CW agents, such as chromium VI (classified as a carcinogen by the CDC) in the older C2 filters, but it is unclear if this enters the airstream you breath. Substances not filtered include ammonia, carbon monoxide, nitric oxide, and carbon dioxide. Phosgene rapidly degrades all filters. M13A2 Filters with green/dark rings (for M17-series mask only): Similar (slightly lower) protection as C2-series. Also contain chromium VI. Much harder to replace in contaminated environment. Not NATO compatible. East German M10M filters (marked "VSK") are not M17 compatible, even though they look similar.

### Commercial Filters:

3M FR64: Recommended filter for any NATO-threaded mask, appears to have the highest and broadest protective indices. \$47.

Scott NBC22, CF32, M95, and M98: Similar to FR64. \$30

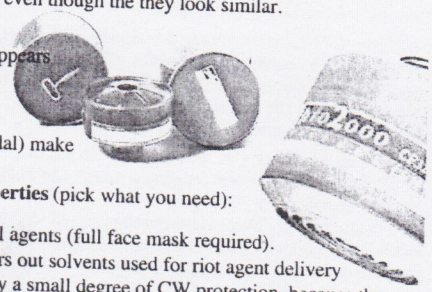

Numerous Manufacturers (MSA, North, 3M, Scott, Dräger, Laerdal) make filters, but they often only work on that manufacturer's masks.

Combination filter "stacks" are available with the following properties (pick what you need):

Sufficient for Rioting Agents & their Solvents

- **P100/HEPA [FFP3 in Europe]:** Riot agents, biological agents (full face mask required).
- **Activated Charcoal (Organic Vapor-Pesticide):** Filters out solvents used for riot agent delivery (methylene chloride, *etc.*), and theoretically provides only a small degree of CW protection, because the activated charcoal is sometimes not impregnated with a metal such as zinc, unless the filters are specifically rated for pesticides or "NBC."
- **Radionuclide:** Only if filters are rated to remove radioactive particles will they also provide coverage for some possible nuclear contaminants (For peace activists working in Iraq, Afghanistan, Yugoslavia & Kosovo, *etc.*: DU dust is several microns in size and so should be easily filtered out by all P100 masks).
- **"NBC" printed on the filter** indicates that a filter meets military, NIOSH, or OSHA specifications for nuclear, biological, chemical exposures. Consists of special kinds of activated carbon (*e.g.*, ASZ).

NOTE: Filters degrade in effectiveness once exposed to air. They are usually packaged air tight (in bags or with sealed caps in the case of canister filters). The main problem is that the activated charcoal absorbs organic molecules from normal room air, thus using up its filtering capacity. Break the sealed caps the day before an action (but not AT THE ACTION, because they can sometimes be tricky). Once open, the life of filters varies. READ ALL ENCLOSED INSTRUCTIONS.

NOTE: All filters lose effectiveness as they absorb agents!! Chemicals, biological agents, and normal dust and pollen will result in increased resistance to breathing. As with all equipment (climbing gear, *etc.*), it is a judgment call when to replace yours. P100/HEPA/FFP3 filters can probably be used as long as you can easily breathe through them. When they've absorbed a lot of Rioting Agents or dust, they slowly clog, and it will become gradually harder to breathe through them. They do not let Rioting Agents through as they clog. P100/HEPA/FFP3 "half-masks" should be replaced if they are sprayed at directly, since solvents may break down the filtering material.

Chemical agents will also affect the activated charcoal component of a filter canister, which is NOT easy to recognize. Users may start to smell chemicals after the activated carbon is depleted, at which time it may be too late considering the lethality of some chemical agents (G agents, *etc.*). Change filter immediately if breakthrough is noticed! Essential oils can also be used to test the seal of the mask and as a rough test for effectiveness of filters: the military uses a cotton swab dipped in isoamyl acetate (banana essence) held near the seals with the skin and briefly near the filters. If you smell banana, either your mask fits poorly or your filters are dead. Users must keep track of time of exposure to deadly chemicals to judge whether the filter will still provide protection. The FR-64 canister, for example, filters a sarin testing surrogate (DMMP) for 59 minutes, phosgene for only 25 minutes, and CS/CN for at least 480 minutes (see 3M Tech Data Bulletin 153 - FR64). During the US military siege against a religious sect at Waco, Texas, gallons (possibly hundreds) of CS gas (and solvent!) were pumped into an inhabited enclosed space, which would overload filters sooner than 480 minutes. Activists could face similar situations in this rapidly deteriorating world.

## The Craft of Tear Gas

Tear gas has been around for some time and many of our customers have had the distinct opportunity of actually experiencing it first hand. Producing quality grenades and projectiles can be very challenging, especially when it requires customization. The manufacturing staff pays close attention to detail, retraining on a regular basis, maintains adequate inventories of materials and components and stays disciplined on their procedures and keeping a work environment decontaminated. Otherwise it would end up with a big mess!

Each year DT/FL manufactures thousands of grenades and projectiles in over one hundred configurations of CS, CN and a variety of smokes. The unique line of products ends up in officers' hands all over the world. So, we thought you might like to know what goes into building something like a colored smoke grenade.

**Step 1** - It all begins on the "gas side" where the raw materials, including acids, are mixed and blended creating a dough like mixture. The doughy mixture is allowed to dry into solid chunks and when it is granulated. It's dubbed the "gas side" because of the odor of CS and CN can become quite pungent during the process. Everyone working in this area wears level C protective equipment.

**Step 2** - The dry granulated formulation then goes to a press where it is pelletized to conform to the grenade or projectile where it is intended to reside. Several of the pellets are then stacked in a grenade canister with spacer rings.

**Step 3** - An igniter formulation is made and poured into the grenade canister with the pellets. After the igniter formulation dries out and forms a solid, a lid is rolled onto the top. The grenade is then sent next door to the "assembly side."

**Step 4** - The assembly side is an area that is cleaned meticulously at the end of every manufacturing day. Working here does not require level C protection. All the grenades will be cleaned, identified by lot number, inspected, and packaged. Afterwards, the grenades will leave the chemical manufacturing facility and be transferred to the silk screen department where the part number, logo and warnings appear. Fuzes will be applied in the final production step.

At any given time during the year, there may be as many as fifteen employees working in the tear gas plant. A core group has been working together building tear gas for 5 years, managed by Ron Lesko, a 13 year veteran of tear gas manufacturing. "We enjoy the challenge, and manufacturing chemical agents is somewhat of a craft," says Lesko. He goes on to state, "mostly it's about the people who work here and their commitment to making a quality product that others can depend on."



Dried smoke formulation is pressed into pellets and put into grenade canisters.

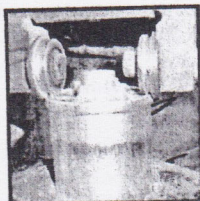

The igniter formulation is added and a lid is securely rolled on top of the canister.

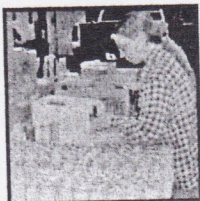

On the assembly side, grenades are cleaned, inspected and identified by lot number.

## DT/FL People

A close up of the people behind the products

### Customer Service

**Darcy Wood** - Central Region Customer Service Representative. Darcy was born and raised in Wheatland, Wyoming. After obtaining her



Associates degrees in Theatre and Office Administration, she relocated to Oregon and worked in Customer Service for Sanipac. She came back to Wyoming and began in Customer Service at Defense Technology in 2001. Darcy is a mother of two girls, ages 8 and 4, and instructs a water aerobics class in her free time.

**Tena Romero** - Western Region Customer Service Representative. Tena was born in Torrance, California. She came to Wyoming in 1993 and began at Defense



Technology in 1994. In her tenure at Def-Tech, Tena has held positions in accounts payable and receivable, aerosol manufacturing, purchasing, and as shipping manager. She came to Customer Service in 2003 and also coordinates all ATF transfers for Defense Technology. Tena enjoys hiking and swimming with her husband of 12 years when she is not working.

**Sherry Lesko** - Eastern Region Customer Service Representative. Sherry was born in Geneva, Ohio and raised in Jefferson, Ohio. She has worked for



Defense Technology for 8 years. After working in Research & Development and Product Liability for several years, Sherry came to Customer Service in 2001. She enjoys cooking, camping and fishing with her husband, and spending time with her pets.

# Smoke Bombs

## Smoke In Their Eyes!

Many times the object of an act of ecotage is to disrupt or delay an activity. A very useful tool in the monkeywrencher's bag of tricks is the smoke bomb or smoke grenade. A wide variety of these are available to the public with no legal restrictions on their purchase. These devices are safe to use and offer the imaginative monkeywrencher many options for upsetting the activities of the greedheads who damage Earth for fun and profit.

Although it's possible to make your own smoke bombs at home, this is not recommended for two reasons: 1) if you do it wrong the things won't work, and 2) if you really do it wrong you blow yourself up. A wide variety of smoke bombs and grenades can be bought by mail with no record or legal hassles. The commercially-produced devices come in two basic types. The first type is designed to be ignited by lighting the fuse. The second type is designed to function like a hand grenade. The user pulls a pin and the device self-ignites several seconds later. These devices generate very large amounts of smoke (anywhere from 3,000 to 115,000 cubic feet), and will make smoke for up to ten minutes. These smoke bombs and grenades even come in a variety of smoke colors. White, gray, red, green, yellow, and violet are available. To give you an idea of the quality of smoke produced, burning crude oil has a TOP (Total Obscuring Power) rating of 200; some of these devices have a TOP of 2100.

### How To Use Them

The most effective use of these devices is in booby traps and ambushes. Both of these uses allow the monkeywrencher to be safely away when the crap hits the fan. Examples: R.J. Hardhead calmly seats himself in the driver's seat of his dozer ready for another day of tree trashing. He is unaware of a fine piece of fishing line running from his dozer blade to the smoke grenade taped securely under the dozer. As R.J. starts up and lifts the blade, the grenade pin is pulled loose and the dozer and a very confused driver are swallowed in a large cloud of green smoke. After the smoke clears, he and his buddies waste even more time figuring out what happened.

A. Motorhead, ace cross-country motorbike racer, surges into the lead at the Annual Dirt Maniac Race. He doesn't notice the thin nylon line running from a firmly-planted stake to the pin on a smoke grenade taped to another stake a few yards away. As he and dozens of others yank the pins from these scattered grenades, clouds of multicolored smoke fill the air, forcing those behind them to stop short or risk kissing an unseen cactus or rock.

The smoke bombs with fuses can be used as in the first example but the fuse needs to be taped to a part of the machine which gets hot enough to ignite the fuse (exhaust pipe or manifold).

These devices aren't cheap but when used well they're worth a lot. Besides after you've gotten R.J. and his buddies paranoid, think what a beer can painted the color of your smoke bombs (and hooked-up to make them think it's real) will do. By the time they get the bomb squad out there to collect the evidence, they'll have wasted an hour or more. Then when they start up something else; POOF! goes the real one. Be creative. Rig the porta-john door. Use them for early warning devices on protests to slow the bad guys down and to let the protesters know where they are.

Keeping a couple of smoke grenades on hand to toss out the window while fleeing the scene of an act of ecotage is a good idea too.

The use of smoke bombs and grenades is a very easy and effective method of ecotage that poses little risk of injury to either man or machine. Other than causing panic and high blood pressure, the smoke does not hurt people. Care

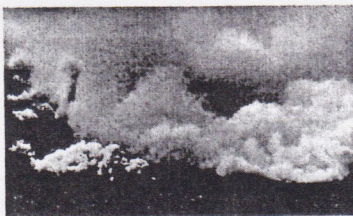

# CHEMICAL

When crowd resistance elevates, our chemical grenades and projectiles offer solutions for both indoor and outdoor situations. Alternatives such as OC, CN, CS, and Smoke provide coverage in pyrotechnic and non-burning carriers. These grenades and munitions offer the maximum force option in the management of crowds and the control of civil and correctional disorder.



## NON-PYROTECHNIC CHEMICAL DEVICES

- Muzzle blast deploys agent directly on suspect or to area
- Heavy concentrations of payload
- High contamination factor
- Instantaneous blast dumps agent from grenade without a pyrotechnic charge
- Muzzle blast can be used to fill in weak areas of a release line

1042 CS Instantaneous Blast Powder Grenade (Not Shown)

1043 Inert Instantaneous Blast Powder Grenade (Not Shown)



**1040**  
OC Instantaneous  
Blast Powder  
Grenade



**1141**  
37 mm CN Muzzle  
Blast Powder

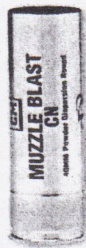

**6041**  
40 mm CN Muzzle  
Blast Powder



**1026**  
CS Triple-Chaser®



**1082**  
CS Riot Control



**1026**  
CN Riot Control



**1016**  
CS Pocket Tactical



## PYROTECHNIC OUTDOOR CHEMICAL DEVICES

- High volume pyrotechnical grenades
- Delivers large plumes of smoke and agent
- Ideal for release line deployment for chemical agents
- Pocket Tactical delivers over 30 seconds of agent from a small device
- Utilizes standard fuze

1072 CS Spede-Heat™ (Not Shown)

1017 Smoke Pocket Tactical (Not Shown)

NEW!

**X2™**

## The Next Logical Step

First Defense® is the most widely used, safest, and most-trusted brand of pepper spray in the world. First Defense X2™ has all the attributes of First Defense®. The only difference is a higher level of capsaicinoids. First Defense X2™ is based on the foundation of First Defense® in that it is all food grade ingredients, water soluble, non-toxic, non-flammable and environmentally friendly.

The OC manufactured for First Defense X2™ also uses an environmentally safe propellant, nitrogen, to project a stream 12 feet. For those of you who think it's time for something a little extra spicy, there is now First Defense X2™ - The next logical step.

Call your Armor Holdings Sales Representative for more information today.

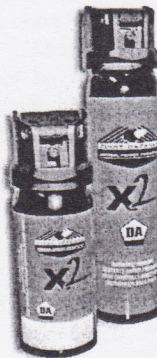

5239

5249

should be taken with these devices, though. There is no point in saving a forest from the bulldozer by accidentally burning it down. A number of available military handbooks detail the uses of these devices. Check your local military surplus shop or a paramilitary mail order store for copies.

—Mooncrow

### FIELD NOTES

\* As always, be extremely careful when mail ordering anything used for monkeywrenching. Leave no paper trail.

\* All fur shops are equipped with smoke detectors and sprinkler systems. A smoke bomb set off in a fur shop will set off the sprinklers and cause expensive damage.

You can make a harmless noise bomb by sealing a piece of dry ice in a plastic soda bottle with a little bit of water; for a distraction, try throwing these away in garbage cans a block or two from police activity.

To apply paint from a distance, **YOU CAN** also fill up light bulbs or Christmas tree ornaments with it, and throw. On an entirely different subject—has it occurred to you that the Achilles' heel of riot gear is that the wearers need to be able to see out?

You can buy professionally made smoke bombs from fireworks vendors; they might even work better than homemade ones. But making them yourself is cheaper, can leave less of a trail, and involves you in the process, so you can manufacture them according to your needs.

SALTPETER

SPOON

CIGARETTE LIGHTER

SUGAR

STOVE

OLD COOKING POT

BOWLS OR ICE CUBE TRAY

Mix two parts sugar to three parts saltpeter in the cooking pot. Heat this over a *low* flame, stirring constantly until it melts; this will take several minutes. Pour the mixture into an ice cube tray, or into bowls, depending on the size you want to make the smoke bombs. Allow them to cool and harden, and remove them from your molds. Once dried, they may get sticky in warm, humid weather—they're partly sugar, after all—but they will still work.

To apply one, light it with a cigarette lighter; this may take up to fifteen seconds. We don't recommend using matches to light them, as it is difficult to keep matches burning this long unless there is no wind. These smoke bombs burn like sparklers, rather than exploding suddenly. Once lit, they can be thrown without going out. A smoke bomb the size of an ice cube will burn for perhaps twenty seconds. We made one the size of a fist, and when we tested it outside we were sure the fire department was going to come. One source recommends embedding matchsticks in them before they have dried, to aid in the lighting process; there are bound to be ways to arrange a delayed ignition, as well.

# R.C. Weapons & Ammunition

## 37/38mm Launcher

RC13  
Tactical Launcher.



## Tactical Launcher 37/38mm

RC14  
Designed and built for law enforcement. 2 grips for more control and better handling of the weapon. Chambered for 3738/mm shells.



## Multi Launcher

RC15  
Type of action:

- Double action trigger
- Safety: Trigger lock
- Caliber: 3738/mm OR 40mm
- Capacity: 6 shots OR 8 shots
- Ammunition: 37mm OR 40mm



## Gas Projectile CS/OC 37-38/40mm

RC16  
Contains 13- separate sub-munitions that release a CS smoke agent. The multiple sub munitions provide a wide area of coverage for quick dispersal and control of crowd.



## 12ga Impact Munitions

RC17  
12ga: Impact Munitions, Ballistic Bag, Distraction Round, Flash & Bang.

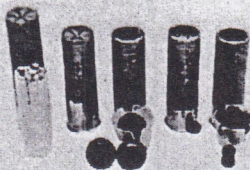

## Rubber Balls

RC18



## 40mm Sponge Grenade

RC19  
The non-lethal 40mm crowd dispersal round is intended to be a direct fire, low hazard, non-shrapnel-producing device which will produce non-lethal effect upon impact.



## Single-Use Gas Launcher

RC20  
Single use, manual launcher. Launches 24 payloads of CS/CN gas to a distance of 5070-meters and 25 meters radius.





## Fun With Slingshots

This versatile tool, available at large discount houses for a few dollars, can be used to knock out office windows from the relative safety of a passing car. In the illustration you will see the conventional type (a) and the more compact and easily concealed folding variety (b). Missiles must be small, dense and relatively round (c). Avoid irregularly shaped objects (d), as they don't fly true. Small rocks, steel bearings, and large nuts (e) are good. In illustration (f) you can see how one or two slingshoters can hit a target from a passing car. The hand holding the slingshot must not extend outside the vehicle (f). The driver must signal when it is safe, ensuring that the hit cannot be observed by nearby drivers. Avoid using your brake lights or deliberately slowing down and then making a fast getaway. Try a couple of practice sessions on a remote country road first. To a passerby, the hit must be indistinguishable from the actions and movements of a typical passing car.

Accuracy with a slingshot comes only through practice. Shooting into an empty cardboard box from gradually increasing ranges is good practice. Do this in a remote area, rather than leave your backyard littered with the same type of ammunition found at the scene of the hit.

—William Tell

### FIELD NOTE

\* Round ice (the kind sold in machines) is an excellent pellet for slingshots involved in night actions. They can be shot through windows, breaking the window, but then melt, leaving no evidence. They do not break plate glass, but are fine for thin glass.

\* Paint pellets (used in CO<sub>2</sub> air splat guns for war games) can be fired from slingshots. They are water-based paint in gelatin. This means they are politically-correct—biodegradable—but the paint splat does not last long on your target. Unfortunately, some break with the initial pull of the slingshot.



### 12-Gauge Area Round

**Manufacturer:** Defense Technology Corp.

**Vendor:** Defense Technology Corp.

**Approximate Cost:** \$2.80

**Participating Services:** Army, Air Force

**Description:** Eighteen rubber ball projectiles with a total weight of approximately 0.2 ounces are contained in a 12-gauge shotgun shell that is approximately 2.5 inches long. The round is prominently marked to be physically and visually identifiable during daylight hours and under conditions of reduced visibility.

**Operational Capability/Use:** The projectiles deliver strong blows to the body and provide the capability to stun or deter several people without penetrating the body. The round is designed to be fired at the center mass of an adult subject at distances between 10 and 20 meters. In crowd control situations, this munition gives soldiers or law enforcement officers a multishot, nonlethal capability to break contact or to enforce a buffer zone.

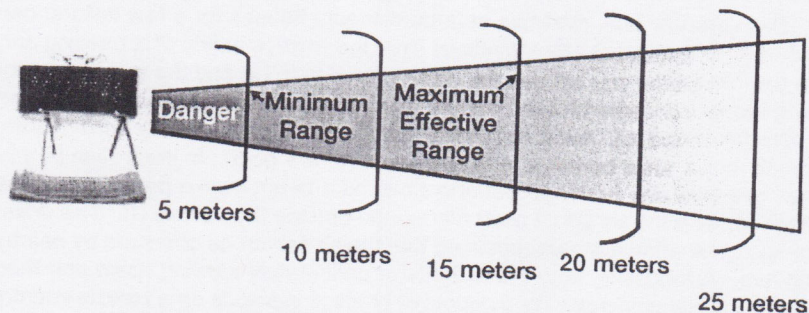
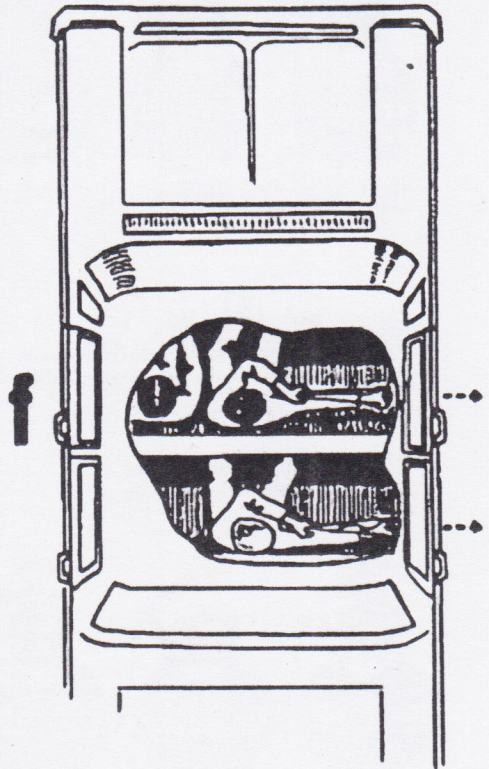
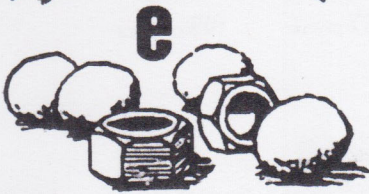
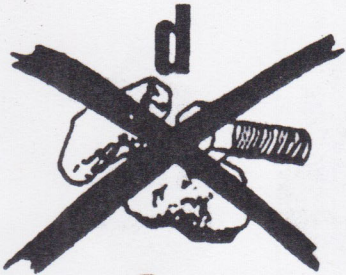
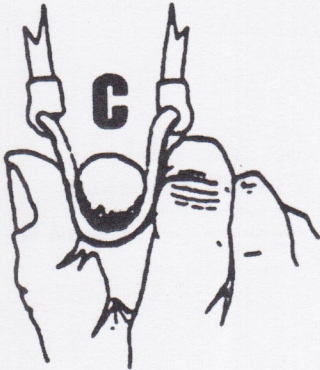
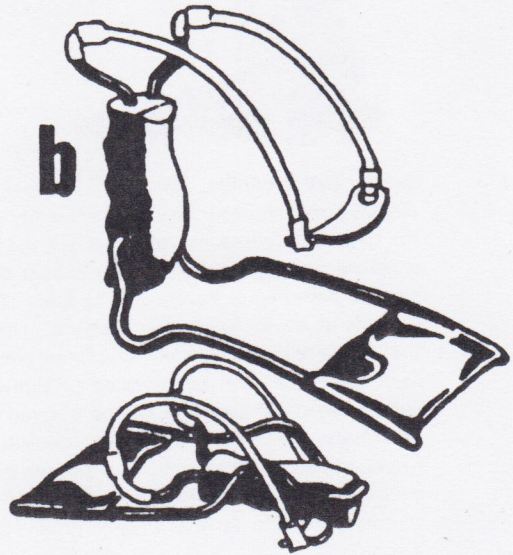
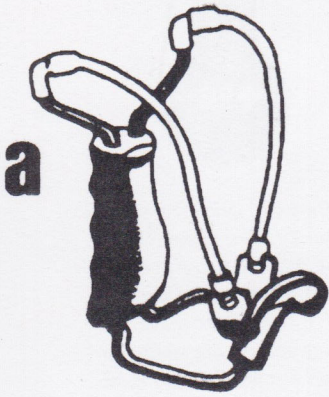
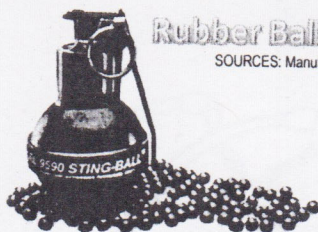

Figure A-42. MCCM-GE Range Chart

#### 4. 66-mm Vehicle Mounted Nonlethal Grenade Launcher (VMNLGL):

The VMNLGL is a nonlethal grenade-launching device mounted on high mobility multi-purpose wheeled vehicle (HMMWV). It is an indirect fire-support system that can deliver a 66-mm distraction device (flash-bang), CS, or blunt trauma (sting ball) payload. The distraction grenade uses a pyrotechnic charge for crowd control through audio and visual stimuli. The blunt trauma grenade uses a pyrotechnic charge to discharge 140, .32 caliber (cal.), rubber balls to achieve crowd control through audio, visual, and physical stimuli. The force uses VMNLGL to enhance the ability of friendly forces to conduct force protection without direct contact with hostile or threatening crowds. It enforces standoff distances and deters potential threats. It can disperse or subdue crowds, keep personnel from surrounding or climbing on patrol vehicles, slow or stop threatening personnel or vehicles by confusing, disorienting, and/or temporarily incapacitating individuals for capture. The grenade is fired from the grenade launchers traditionally found on tracked vehicles. Vehicle-launched grenades have three submunitions designed to ground burst. Effective range is 50 to 100 meters. An adjustable bracket allows engagement at ranges of 50 meters, 75 meters, and 100 meters. (Figure A-44)





## Rubber Ball Grenades

SOURCES: Manufacturer Literature



**Rubber Ball Grenades.** This grenade is hand-thrown. Once the safety pin has been removed the grenade is ready to be thrown. Once thrown, the spoon is released and, after a delay, the fuse detonates the grenade expelling one hundred .25 caliber rubber balls from the grenade in a circular pattern out to about fifty feet. The rubber balls leave the grenade at about 700 feet per second. These grenades are unique in that they are the only kinetic less-lethal weapon not limited to line-of-sight use – they can be launched or thrown beyond an obstruction. Some rubber ball grenades can be ordered with OC or CS payloads. Considerations include location of fellow officers with respect to the thrown grenade and vulnerability of eyes. Additionally, a launched rubber ball grenade will have a fuse assembly falling to earth at an uncontrolled location.<sup>10</sup>



**1090**  
Rubber Pellet Only



**1088** CS



**1089** OC



### STINGER<sup>®</sup> Rubber Ball Grenade

- Area deployment device
- Maximum stimulus overload via light, sound, impact and agent delivery
- Launcher-deliverable device



### RUBBER BALL BLAST Grenade

- Distraction / delivery device can be used in close proximity of people
- Area deployment device
- 1.5 second fuze

**1096** CN Blast (Not Shown)

**1098** Practice (Not Shown)



**1097** CS Blast



**1095** OC Blast



**1092** CS



**1091** CN



**1093** Saf-Smoke<sup>™</sup>



### HAN-BALL<sup>™</sup> Pyrotechnic Outdoor Chemical Grenades

- Pyrotechnical device in a rubber ball
- High volume of agent delivered in 15 seconds
- High body temperature hampers it from being picked up / thrown back



**C. Spray-Paint.** If there is no time to make paint bombs, cans of spray paint can be used to blind riot police. This requires standing within arms reach and spraying facial

area and/or shield.

**5. Projectiles.** Thrown or fired objects can injure, slow down, and have a psychological impact on riot cops (even if protective armour limits potential damage). Whenever a barricade or position is established, the gathering of projectiles should be ongoing. Common projectiles include:

**A. Rocks.** Fist-sized rocks can be thrown with some force & accuracy a distance of 40-50 feet. Aim at head, upper body, arms or legs. Although common, rocks should be gathered and stashed at certain points and/or carried in pack.

**B. Concrete/Bricks.** In urban or suburban areas, pavement & bricks can be dug up and used as projectiles. Large concrete chunks & bricks should be smashed up to make smaller throwing pieces.

**C. Slingshot.** As noted, slingshots can be used against riot police face area, as well as windows.

**D. Paint-bomb.** Can be used to blind riot cops (see above).

**E. Molotov.** Can be used against riot cops to injure or stop advance, to disable vehicles and set fire to barricades.

**F. Flares.** Flares that shoot out can be used to fire on police formations, causing panic, confusion, and possible injuries. The best are pen-type flare launchers.

**G. Fireworks.** Roman candles & other shooting fireworks can be used to fire on police formations. Some fireworks, such as 'Screecheros', can be modified to make flash-bang grenades.

**H. Bottles.** Empty bottles thrown at police have an intimidating effect when they shatter. Flying glass shards can cause injury. Aim for ground directly to front of riot cop, or aim at head.

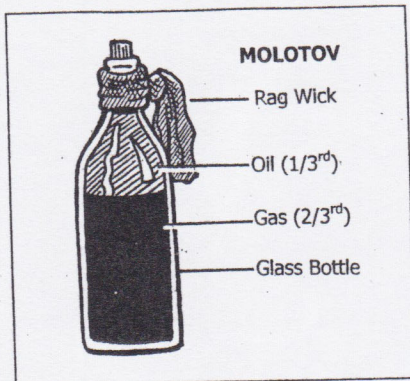

## Throwing Projectiles

Despite their heavy protective armour, riot police are vulnerable to the accumulated physical & psychological effects of projectiles.

*Points to stress:*

- Projectiles should be thrown from the *front* of a crowd, not the rear. This is to prevent injury to the front ranks should your throw be short. Throwing from the front is also more accurate and forceful.
- Projectiles should be aimed at *individual targets* & body parts, not just thrown into a mass.
- Targets directly to the front can be thrown at, but they may see your action & avoid the projectile. Throw at an angle to L or R and you will more likely catch a riot cop off guard.

## TARGETS FOR PROJECTILES

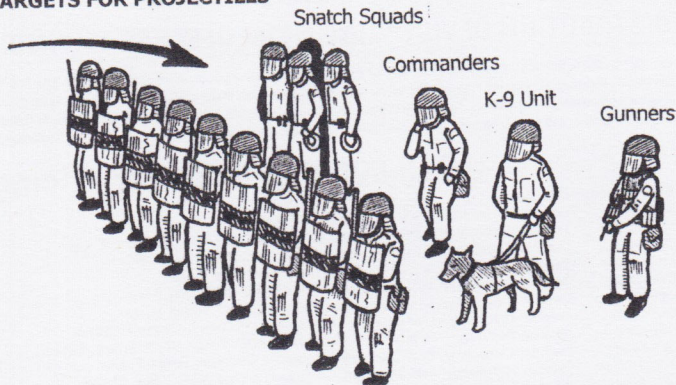

- Primary targets for projectiles are: commanders, ARWEN gunners, snatch squads, and K9 units (none of whom usually carry shields).

# DISTRACTION DEVICE® LINE



DEFENSE TECHNOLOGY

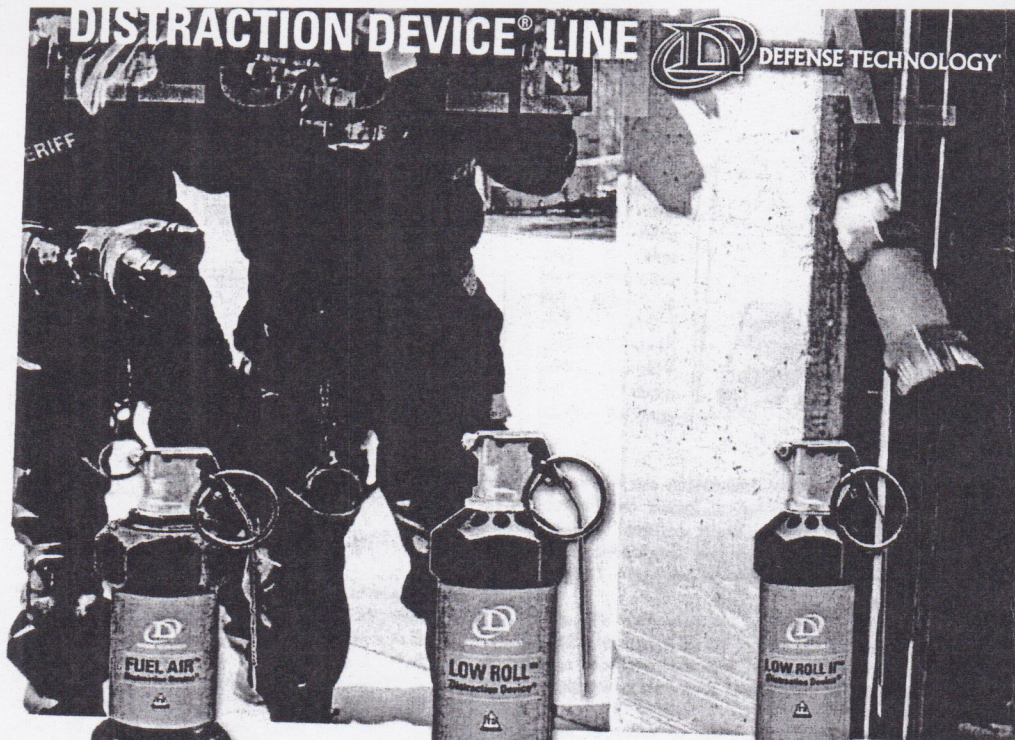

## 8000 & 8001

Fuel Air™ Distraction Device®

Produces 169(+)<sup>1</sup> dB at 5 feet with reduced blast pressure, and the brilliant flash (6 - 8 million Candelas) lasts twice as long as other devices. Offered in a reloadable configuration consisting of a reload charge (Part No. 8001) and a reloadable body (Part No. 8000).

## 8902NR & 8933

Low Roll™ Distraction Device®

This design shouts reliability and durability, producing an amazing 175(+)<sup>1</sup> dB at 5 feet and 6 - 8 million Candelas with 10+ millisecond duration. Offered in a non-reloadable (Part No. 8902NR) and reloadable (Part No. 8933) Low Roll body configuration.

## 8922

Low Roll II™ Distraction Device®

Boasting an amazing 175(+)<sup>1</sup> dB and 6 - 8 million Candelas, this compact, all-steel body is designed to reduce rolling. Offered in a non-reloadable configuration (Part No. 8922).

## DISTRACTION DEVICE® LINE FROM DEFENSE TECHNOLOGY®

We are pleased to introduce three new models to our industry leading Distraction Device® product line, the Low Roll™, Low Roll II™ and the Fuel Air™. The hyper stimulation delivered through the intense light, sound and shock waves from these devices were designed to expressly meet the needs of tactical professionals in today's demanding environments. This family of three, as with our entire line of Distraction Device® products, delivers on performance, weight, size and close quarters missions, and is manufactured to the very highest standards of safety and effectiveness. Defense Technology. **WE ARE YOUR FORCE OPTION.**

## Call 800-852-6088 For Pricing!

Product Code	Description	Retail Price	Discount Price
DEF-3005	Defense Technology- 5.5% Peppermace MK-3, 1.6oz OC, Tubed, Stream	13.23	Call for Pricing!
DEF-3035	Defense Technology- 5.5% Peppermace Fogger MK-3, 2.4oz, OC, Tubed, Fogger	13.23	Call for Pricing!
DEF-4005	Defense Technology- 5.5% Peppermace MK-4, 3.0oz OC, Tubed, Stream	16.34	Call for Pricing!
DEF-43344	Defense Tech Bodyguard LE-10 Quick Top Tubed/ Cone 1.5oz.	10.85	Call for Pricing!
DEF-5036	Defense Technology- 10% Peppertofoam, MK-3, 2.4oz OC, Tubed, Foam	14.31	Call for Pricing!
DEF-5046	Defense Technology- 10% Peppertofoam, MK-4, 4.2oz OC, Tubed, Foam	16.34	Call for Pricing!
DEF-5069	Defense Technology- First Defense, MK-6, 0.68oz OC, Tubed, Clip Unit, Stream	13.23	Call for Pricing!
DEF-5089	Defense Technology- Inert Training MK-3 Foam, 2.4oz, Inert, Tubed, Foam	11.25	Call for Pricing!
DEF-5136	Defense Technology- Inert Training MK-3 Stream, 1.47oz, Inert, Tubed, Stream	9.18	Call for Pricing!
DEF-5139	Defense Technology- Inert Training MK-4 Stream, 3.0oz, Inert, Tubed, Stream	9.18	Call for Pricing!
DEF-5149	Defense Technology- Inert Training MK-6 Stream, 0.68oz, Inert, Tubed, Stream	10.22	Call for Pricing!
DEF-5169	Defense Technology- Inert Training MK-9 Stream, 12.0oz, Inert, Boxed, HV Stream	9.18	Call for Pricing!
DEF-5199	Defense Technology- First Defense, Stream X2 MK-3, 1.47oz, OC, Tubed, Stream	27.54	Call for Pricing!
DEF-5239	Defense Technology- First Defense, Stream X2 MK-4, 3.00oz, OC, Tubed, Stream	13.10	Call for Pricing!
DEF-5249	Defense Technology- First Defense, Stream 360 MK-4, 3.00oz, OC, Tubed, Stream	15.84	Call for Pricing!
DEF-5449	Defense Technology- Pepper 10 MK-3, 1.47oz OC, Tubed, Stream	15.84	Call for Pricing!
DEF-5839	Defense Technology- Pepper 10 MK-6, 0.68oz	13.23	Call for Pricing!
DEF-5869	Defense Technology- Pepper 10 MK-7, 0.35oz	12.99	Call for Pricing!
DEF-5879	Defense Technology- Pepper 10 MK-7, 0.35oz	10.99	Call for Pricing!
DEF-6005	Defense Technology- 5.5% Peppermace MK-6, 0.85oz OC, Tubed, Clip Unit, Stream	13.23	Call for Pricing!
DEF-9005	Defense Technology- 5.5% Peppermace Fogger MK-9, 17.4oz, OC, Boxed, Fogger	46.80	Call for Pricing!
DEF-9050	Defense Technology- Decontamination Aids 12.3 oz Cool It!	16.07	Call for Pricing!

# DYNAMITE!

Dynamite! Of all the good stuff, this is the stuff. Stuff several pounds of this sublime stuff into an inch pipe (gas or water pipe), plug up both ends, insert a cap with a fuse attached, place this in the immediate neighborhood of a lot of rich loafers who live by the sweat of other people's brows, and light the fuse. A most cheerful and gratifying result will follow. In giving dynamite to the downtrodden millions of the globe, science has done its best work. The dear stuff can be carried around in the pocket without danger, while it is a formidable weapon against any force of militia, police or detectives that may want to stifle the cry for justice that goes forth from the plundered slaves. It is something not very ornamental but exceedingly useful. It can be used against persons and things, it is better to use it against the former than against bricks and masonry. It is a genuine boon for the disinherited, while it brings terror and fear to the robbers. It brings terror only to the guilty, and consequently the Senator who introduced a bill in Congress to stop its manufacture and use, must be guilty of something. He fears the wrath of an outraged people that has been duped and swindled by him and his like. The same must be the case with the "servant" of the people who introduced a like measure in the Senate of the



Indiana legislature. All the good this will do. Like everything else, the more you prohibit it, the more it will be done. Dynamite is like Banquo's ghost, it keeps fooling around somewhere or other in spite of his satanic majesty. A pound of this good stuff beats a bushel of ballots all hollow, and don't you forget it. Our law makers might as well try to sit down on a crater of a volcano or a bayonet as to endeavor to stop the manufacture or use of dynamite. It takes more justice and right than is contained in laws to quiet the spirit of unrest. If workingmen would be truly free, they must learn to know why they are slaves. They must rise above petty prejudice and learn to think. From thought to action is not far, and when the worker has seen the chains, he need but look a little closer to find near at hand, the sledge, with which to shatter every link. The sledge is dynamite.

TENCATE

# Defender™ M

MILITARY & POLICE

The TenCate Defender™ M collection is a range of inherently heat- and flame-resistant fabrics.

## DP 9210 – 210 g/m<sup>2</sup>

Inherently heat- and flame-resistant fabric  
59/29/10/2% Lenzing® FR/aramid/polyamid/Static-Control™

TenCate Defender™ M - DP 9210 sets the standard for inherently heat- and flame-resistant fabrics with excellent colour properties in the dark shades blue and black. This fabric is not only cool and breathable, thanks to its high Lenzing® FR content, but also highly durable due to the use of meta-aramid, para-aramid and polyamid fibres.

**Superior thermal protection** – Protects against heat and flame (complies with EN ISO 11612 A1, A2, B1, C1, F1: 2008).

**Highly comfortable** – Lightweight, breathable and excellent moisture absorption. The fabric feels soft and supple.

**Extremely durable** – Excellent abrasion resistance to provide a long useful garment life. The flame-resistant properties are built in and cannot be washed out.

**Colour** – Superior light fastness and colour fastness after multiple washes.

**Long-lasting looks** – The fabric has been thoroughly tested for its protective properties and has been submitted to an extensive range of washing and durability tests at independent testing institutes.

**Outstanding value** – Suitable for application in protective clothing for the markets, such as Marine Corps, air forces and police forces (including riot police and special squads), which principally wear the colours black or dark blue for their operations.

**Anti-static for explosion risk protection** – TenCate Static-Control™ is a core conductive filament yarn and is 'gridlocked' into the fabric (complies with EN 1149-3: 2004).

**Flashover protection** – Tested at 4 seconds in a sea of flames at a temperature of 800°C (Instrumented mannequin test - ISO 13506: 2008).

**Petrol repellent finish** – Standard.

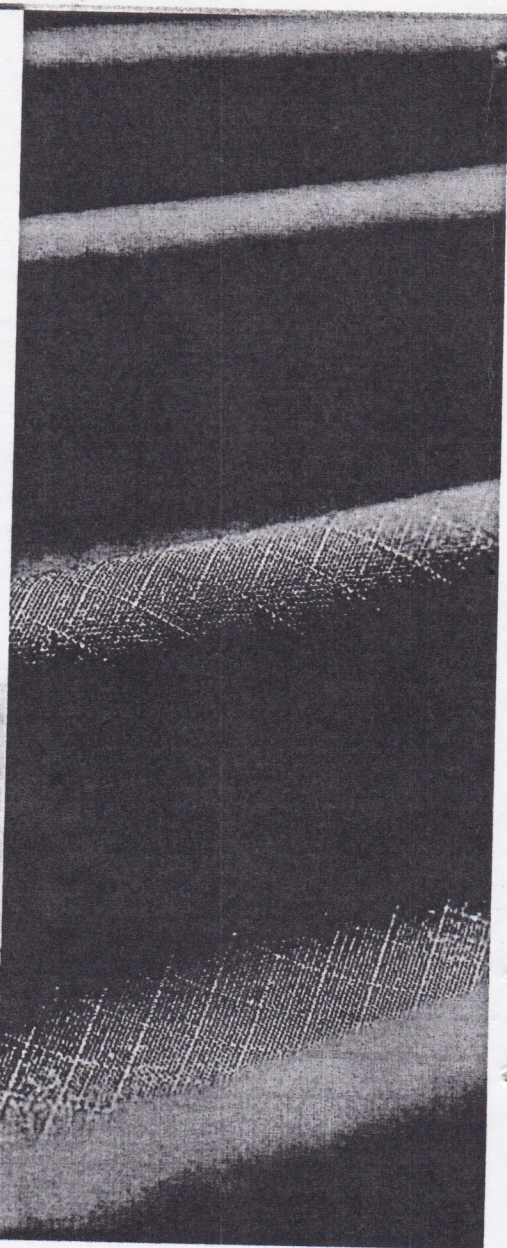

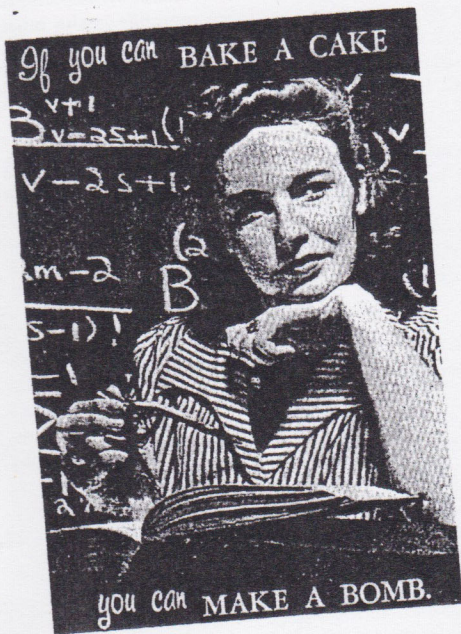

## BOMBA INCENDIARIA ('COCTEL MOLOTOF')

1. LLENAR DE GASOLINA, LUZ BRILLANTE (KEROSÉNI) O COMBUSTIBLE DIESEL UNA BOTELLA DE CUELLO ESTRECHO, MEJOR AUN SI SE LE AÑADE ASERRÍN DE MADERA O JABÓN RAYADO.



2. INTRODUCIR UN TRAPO EN LA BOTELLA HASTA QUE UN EXTREMO ROCE EL LÍQUIDO Y EL OTRO SE EXTIENDA NO MENOS DE 20 CMS DE LA BOCA DE LA BOTELLA. SELLAR FIRMEMENTE LA BOTELLA CON UNA CINTA O VENDA.



3. PARA ACTIVAR EL DISPOSITIVO:

A) SOSTENER LA BOTELLA EN UNA MANO EXTENDIENDO BIEN EL BRAZO.

B) ENCENDER CON LA OTRA MANO EL TRAPO.

C) LANZAR INMEDIATAMENTE LA BOTELLA ENCENDIDA CONTRA EL OBJETIVO, CON FUERZA SUFICIENTE PARA QUE SE ROMPA AL HACER IMPACTO.



0.1

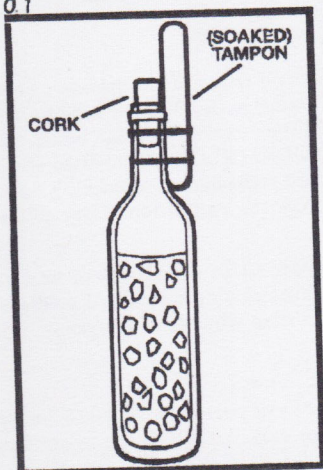

You can mix styrofoam into gasoline to make it stick—this recipe has been used for the filling of molotov cocktails.

¡Soldado nicaraguense! ¡Miliciano nicaraguense! Una forma muy eficaz de sabotear a la tiranía marxista es negándose a servir militarmente sus designios de opresión imperialista. De un paso decisivo hacia la libertad de Nicaragua incorporándose, con tus armas si puedes, a las filas de los combatientes por la libertad. Nicaragua libre te espera. Ven a formar filas junto a tus hermanos, dignos herederos de Sandino.



7-34. The riot baton is an invaluable weapon in crowd control situations. A riot baton in the hands of a well-trained control force member is the most appropriate weapon, except with extremely violent crowds. The riot baton is not meant to replace NL munitions, but is instead used in situations in which NL munitions are not needed. Losing a riot baton to the crowd does not present a serious threat.

7-36. A riot baton is a versatile offensive weapon that varies in length from 26 to 42 inches with the optimum length being 36 inches. It is made of hickory and does not shatter or break easily. Both ends of the riot baton are rounded to prevent unnecessary injury. It is approximately 1¼ inches in diameter. Each riot baton has a hole drilled at the grip end with a leather thong threaded through the hole. The thong helps secure the riot baton to the user's hand.

4-10. A riot baton in the hands of a properly trained soldier is a formidable weapon. However, it must be used in conjunction with other measures to be most effective. Soldiers must be trained with the riot baton to the point that its various techniques are automatic to them. This training must also include learning the vulnerable points of the human body so they can avoid areas that may cause permanent injury or death when struck.

#### WARNING

The riot baton is never raised above the head to strike a subject in a club fashion. Not only is it likely to cause permanent injury; but it also gives an unfavorable image of the control force. The soldier is also vulnerable to an attack on his rib cage when his arm is raised.

#### TYPES OF RIOT BATONS

4-16. The Army is currently fielding two types of riot batons, wooden and expandable. The most common riot baton is the 36-inch hickory riot baton with thong. There is also the 24- to 36-inch expandable riot baton, which has been added to the nonlethal capabilities set (NLCS). Regardless of which riot baton the soldiers are equipped with, all techniques for blocking and striking are identical. Similar to the riot shield, the riot baton offers soldiers both offensive and defensive capabilities.

4-17. Soldiers must be properly trained in all blocking and striking techniques. Improper use of the riot baton by an untrained soldier has the potential for creating a greater problem than what already exists.

#### NOMENCLATURE OF THE RIOT BATON

4-18. The riot baton is divided into four basic parts: the long end, long portion, grip portion, and grip end (see Figure 4-5). Although the expandable and wooden riot batons differ, their nomenclature is quite similar.

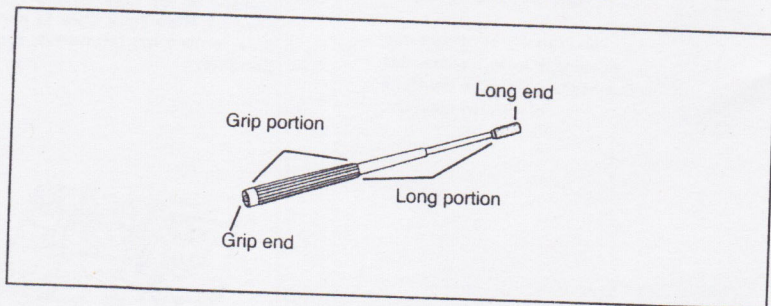
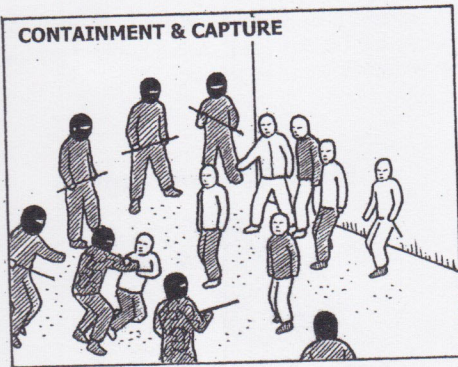

Figure 4-5. The Riot Baton



**Batons/Staves.** In some riot situations, it is not possible to enter an area carrying large batons. Covert methods of carrying baton sticks can be as part of banners, flag poles, in bags carried by sympathizers. When needed, they can be pulled out & used.

Against riot police, the 3' long Hanbo is preferred (or even longer staves of 5-6'). To break through plexi-glass shields & visors, metal pipes or aluminum baseball bats can be used. Baseball bats will also have greater impact against fully armoured riot police.



·Defensive gear: banners, shields (possibly disguised as puppets or placards), steel-toed shoes (should still be comfortable for running!), body armor or padding, gas masks or goggles and bandannas soaked in lime juice (store in ziplock bags until necessary), rain coats or chemical protection gear (if there is a risk of chemical attack), whatever relevant medical supplies you know how to apply, etc

·Offensive gear: spraypaint, projectiles, slingshots, signs or flags on thick poles (or just plain poles), molotov cocktails, bright lights (to obscure police or camera vision during night actions), ladders and/or bolt cutters for scaling or breaching barriers, etc.

## Points to Remember

Any time there is a protest situation expect the media to be present. Expect video cameras to be present documenting the activity and the actions of the police. It is important to remember that some groups will intentionally bait police into the use of force as a publicity stunt for their cause. Remain professional when dealing with the protesters.

Remember the Force Continuum starts with Officer Presence. We need to look the part to be effective. If verbal commands to disperse should fail, here are some 'soft hands' techniques to consider.

### Pressure Points

**Hypoglossal:** This affects the most sensitive area of the hypoglossal nerve located approximately one inch forward of the mandible jaw angle and one inch under the jaw. This technique is applied with touch pressure or sudden penetration. The technique is usually best delivered by using the digital tip thumb or by using the unsupported middle two fingers.

**Mandibular Angle:** Affects the hypoglossal, vagus, and the glossopharyngeal nerves. APPLIED WITH TOUCH PRESSURE. Pressure should be applied at the base of the earlobe between the mastoid and the mandible. The angle of pressure should be toward the center of the head and slightly toward the nose.

**Jugular Notch:** Affects the superior laryngeal and recurrent laryngeal nerves. Located between the trachea and small nerve fibers in the jugular notch region. APPLIED WITH ONLY SUDDEN PENETRATION. Pressure is directed toward the center of the body at an approximate 45° angle. This pressure point can be used as a means of distraction to precede other control methods or to move uncooperative subjects who may be handcuffed. It is best applied with the middle two fingers or thumb. Note: Continual and extensive pressure following compliancy can decrease pain and increase resistance in subject.

If pressure point techniques fail, have an alternate control plan option available. If OC is used, document how many times the person was warned before the OC was used. Active levels of resistance – pushing, pulling, shoving, etc. – should NOT be met with pressure point tactics.

### Hypoglossal Nerve



### Mandibular Angle



# KARATE IS PUNK

By Buddha

Karate? yes, karate! not only could karate be valuable self-defense, but, you know, kicking people is just plain fun! i know, it's not very "p.c.", but as Var once said, "don't be p.c., be Bruce Lee." and Var knows his shit! do this: put on Filth's 7" really loud, so you can hear it outside of your house. then, either watch from a window or hide in a shrub or something, but just watch for the first innocent pedestrian to pass in front of your house. then, when they get right in front of your house, run out and kick 'em!!! then run inside (really fast!) and lock the door. this is exelent. karate is pretty easy to learn, depending on how loosely you define it. for instance, is simply kicking some body karate? or do you have to go "Hieefah!!!"? some people might say that you have to take all sorts of lessons and shit to really know karate, but i think they're just scared of having fun. posers! i say anybody can learn karate in about as long as it takes to rob a drug store! destroy everything in sight with powerfull blows! no future!

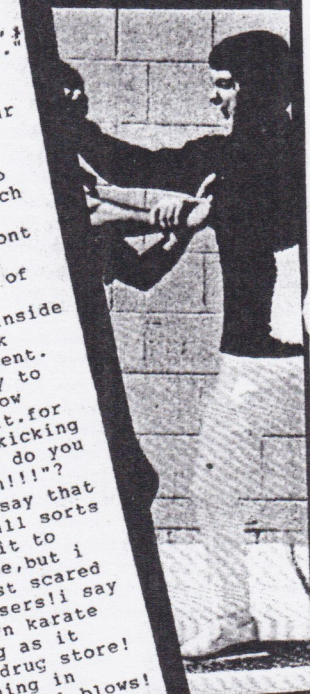

\*ed - VAR NEVER said THIS BRIAN JUST "MADE IT UP"

can shadow groups, provide surveillance and report to commanders. BRRT patrols can be divided into smaller groups to enhance coverage or quickly merged into larger teams to meet the needs of dynamic and ever-changing situations. Perhaps one of the slickest uses of a BRRT is as an arrest team. Because they're able to move into a crowd quickly, quietly and with less commotion, the bike team can swoop in, surround a suspect or provocateur, effect the arrest and quickly extract them under the protection of a moving bicycle barricade.

Bike teams use formations and tactics (lines, wedges, slants, etc.) employed by other crowd control teams, but do them while riding police bikes. Therefore, the riders must be both proficient in police bike skills—including slow speed and precision bike handling, even while wearing a gas mask—and trained to operate as a coordinated and cohesive crowd control unit. They do this through simple verbal and whistle commands and hours of practice and scenarios.

Before the 2008 RNC in Saint Paul, the Saint Paul PD partnered with bike teams from Minneapolis, as well as a few suburban departments to select, equip and train roughly 120 bike officers, forming 8–11-officer teams. A sergeant and a squad leader, usually an experienced and trusted officer, led each team. Training went on for several months. It involved group riding, communication and tactics, learning to ride and perform with gas masks deployed, and scenarios implementing "gas," noise and the commotion they expected to encounter.

Throughout the media's coverage of the RNC events, the bike teams were omnipresent. It seemed that nearly every time the media filmed some sort of skirmish, the bike teams were in the middle of it. Many clips are still available on YouTube and on the official RNC Commission Report and Executive Summary ([www.stpaul.gov/index.aspx?NID=2901](http://www.stpaul.gov/index.aspx?NID=2901)).

Bike team leaders reported throughout the week that they knew BRRT's and their tactics would work, but they were surprised at how well they worked. Bike teams literally kept the city from being destroyed—and the citizens knew it. Many bike team members were pleasantly surprised when pedestrians would stop and applaud as they rode by in formation.

Perhaps the best demonstration of their success followed a particularly long day of dangerous confrontations. At one point, the bicycle response teams had moved in to reinforce a "hard platoon" of mobile strike force officers overwhelmed

in their battle with protesters. The addition of BRRT members enabled them to hold their positions and prevent injuries to officers.

Later that day, as the BRRT members rode into a staging area wearing their modest bike uniforms, duty belts and bike helmets, the mobile strike force members—decked out in riot helmets, shields and complete riot pads—stood and



St. Paul police officers push back a group of protesters who were using a large sign during an anti-war protest at the Republican National Convention in St. Paul, Minn., Monday, Sept. 1, 2008.

spontaneously began chanting, "Bert! Bert! Bert!" To have their peers, many of them battle-hardened SWAT and tactical guys, heap praise on these guys and gals "riding bikes and wearing shorts," proved beyond question BRRT's effectiveness and value.

#### Conclusion

As is the case with most aspects of law enforcement, training is the key to a successful BRRT. High-quality training in bicycle rapid response will be offered during the International Police Mountain Bike Association's (IPMBA) 2012 Conference. It will be held, coincidentally, in Saint Paul, Minn.,

April 30–May 2, 2012. For more information, visit [www.ipmba.org](http://www.ipmba.org).



Check Kirby Beck's article "Up & Rolling," about how to start a police bicycle unit, exclusively at [LawOfficer.com](http://LawOfficer.com).

**KIRBY BECK** is a retired police officer and current IPMBA Instructor-Trainer. As a resident of the Twin Cities, he has trained with the Bicycle Response Team trainers and watched with interest the team's success during the 2008 RNC in Saint Paul.

## Breaking the Cops

The pigs are weak – and only human. Despite their uniforms and legal use of violence, they can definitely be broken. The easiest way to break a police line is, if your group is mobile and large enough, to just look for a weak-spot (where your outnumber the cops considerably) and attack it with whatever you have at your disposal – including throwing things rushing it, or even heavy verbal intimidation. They cops might just withdraw or scatter. One of the scariest yet perhaps most effective is the simple countdown and charge – which requires more co-ordination than most groups have, but which Ya Basta! has used successfully. Giant puppets and dumpsters – almost anything! – can also be used as “battering rams” and charged at police and barricades. Police barricades themselves are often the best items to use against the police! Remember that the best offense is a good defense – you can use all sorts of things like newsstands to block off exits and otherwise litter the street to make sure they can't follow you. Dumpsters near bars are often deeply alcoholic thus easily flammable – lighting will lead to massive confusion and panicking by cops.!! Having enough people surrounding the cops always causes them to panic. Remember that a panicking cop is deadly, but often will cause so much chaos that she or he can disrupt any sense of legitimacy the police have, and are more easily neutralized as a threat. Always think of creative ways to get rid of the cops – if the cops are in heavy riot gear, you can always just outrun them, for a “mobile” Black Bloc can wreck havoc to property and defend themselves by moving faster than the heavily armed police who trudge behind. If the cops are on horses, the horses will panic if a whole crowd jumps together, knocking the cops right off!

*Creative use of nearby fences may strike sheer terror in the hearts of the pigs*

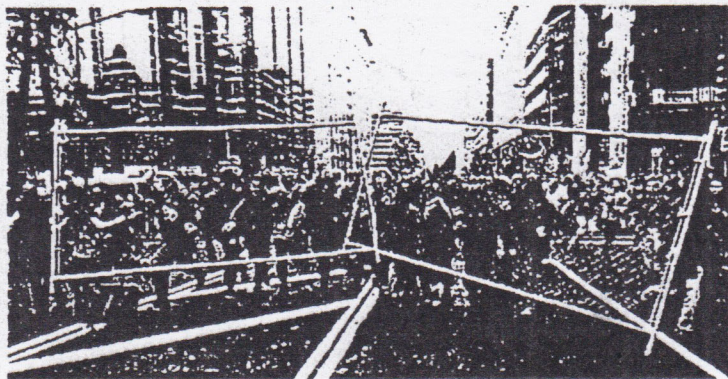

7) Barricades can be more hassle than they are worth. A solid impassable barricade can reduce your own options when you need to run. Bear in mind that anything you build now you are likely to get dragged over later, leave out the barbed wire. The best barricades are random matter strewn all over the place – horses can't easily charge over them, police find it hard to hold a line in amongst them, but individuals can easily pick their way through. If you know police are advancing from only 1 direction & you have clear escape routes behind, barricading can be sensible. The tactics the cops developed during the 1980's riots was to drive vans into crowds with TSG in the back, jump out and arrest everyone they caught. Barricades is an effective way of stopping this.

If they have blocked your only exit try...

-counter advancing: this involves moving your lines into theirs, thus gaining more space and opening up more exits. Use the front line as a solid wall, linking arms and moving slowly forward. Use the banner as a plow (this prevents them from breaking the line but they can still hit you).

-reforming: always look for ways to increase your numbers, by joining up with other groups and absorbing stragglers. Everyone has to get out and you'll stand a better chance of getting out unharmed, with all your belongings and equipment if you leave together at the same time.

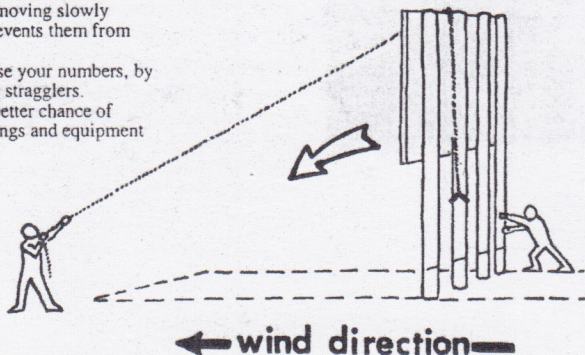

Tie the rope high up on a pole and throw the remainder over the top (you may have to weight the end with a rock). Make sure the rope is long enough to keep you out of the danger zone.

# CROWDSTOPPER

GALVANIZED STEEL BARRICADES

- Security and Safety
- Traffic & Pedestrian Control
- Special Events
- Concerts
- Stadiums/Arenas/Convention Centers
- Fairs/Carnivals/Festivals
- Parades/Rallies



Keep crowds back and enhance security using CrowdStopper® long-lasting barricades. Signature's CrowdStopper barricades are perfect for a variety of crowd control applications. Each maintenance free CrowdStopper is manufactured using 1-1/2" OD 16

gauge steel framing and is hot-dipped galvanized to prevent rust and corrosion for maintenance-free long life.

Each upright is made from 1/2" OD 16 gauge steel tubing and is fully welded to the frame for greater strength (1 1/4" OD 14 gauge frame tubing and 5/8" OD 18 gauge upright tubing is also available with minimum lead times). We offer multiple sizes, locking systems, and foot types to meet your various needs and can ship large quantities from stock.

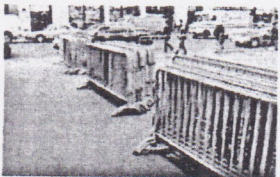
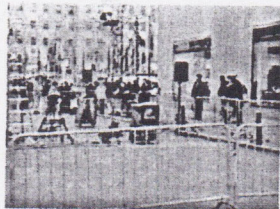

Ideal for use on grass, soft or uneven surfaces. Offers superior resistance to pushing crowds.

Size: 8ft x 43"  
Weight: 52 lbs.

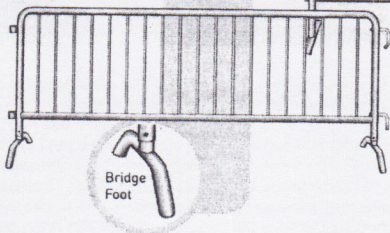

Bridge Foot

## CrowdStopper GS01 > Bridge Foot

The Signature Crowdstopper GS01, with a bridge-style foot, is our best-selling barricade. The bridge-foot design provides maximum stability for the barricade, thus making the GS01 an ideal choice for use on grass, soft or uneven surfaces. The Bridge Foot CrowdStopper provides the best resistance to pushing by crowds - so if you are planning a parade, rally or concert, choose the GS01 for your sensitive crowd control needs.

## CrowdStopper GS02 > Flat Foot

The Signature Crowdstopper GS02, with the flat-style foot, is the ideal choice at special events or venues that require funneling crowds or traffic in parallel lines. The flat-foot design minimizes the tripping hazard and vehicle tires roll easily over the foot without damage to the barricade. Additionally, GS02 is perfect for indoor use over sensitive floor surfaces as the flat foot distributes weight effectively and rubber grommets provide added protection. The GS02 has two holes in each foot which allow it to be anchored to the ground.

Size: 8ft x 43"  
Weight: 57 lbs.

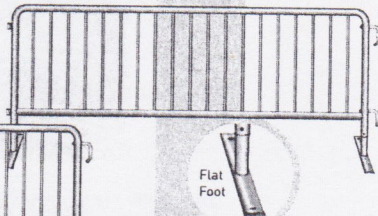

Flat Foot

Ideal for creating parallel lines to funnel crowds or traffic.

CrowdStopper w/ Bridge Foot

CrowdStopper w/Flat Foot





# PVAB PORTABLE VEHICLE ARRESTING BARRIER

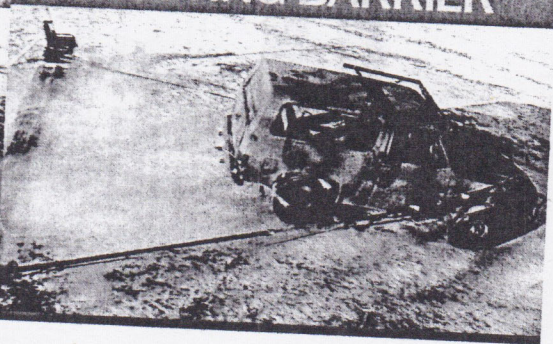
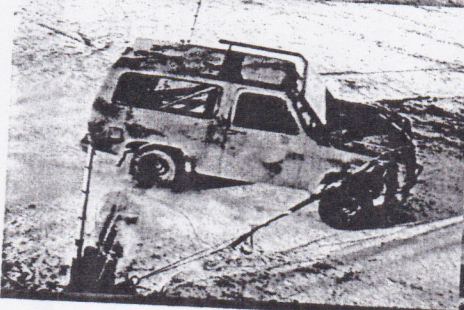

The PVAB is an effective, non-lethal vehicle capture system for use at tactical checkpoints and facility entrances requiring a reliable access denial to vehicle capability. The PVAB is portable, easily emplaced, reusable and recoverable. The PVAB enables security forces to stop forward progress of vehicles without firing lethal weapons at engines and tires. The PVAB is type-classified and qualified, and is in service with U.S. Army, Marine Corps and Navy security forces (NSN 4240-01-469-6122).

### Features

- The only U.S. Government certified non-lethal vehicle barrier
- Saves Lives - Stops vehicles without lethal force
- Vehicle cannot escape after capture
- Net wraps around doors, impeding occupant escape (cars and light trucks)

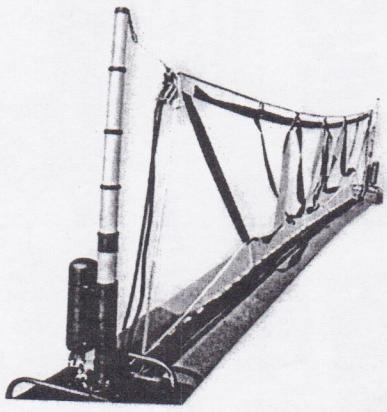

**GENERAL DYNAMICS**  
Ordnance and Tactical Systems

## Barrels and stumps

What they are - they are hollowed out stumps or concrete filled 55-gallon drums, fitted with lock boxes. Each barrel weighs about 1200 pounds when completed.

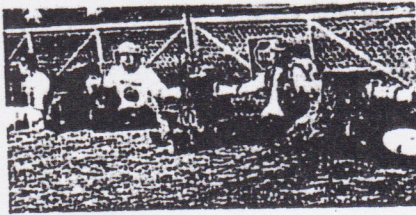

Uses - good for both back woods and urban blockades. But remember the barrel is heavy and you have to get them to your target. Stumps are lighter and easier to transport.

-place in front of gates and doors or across train tracks and highways.

### Materials needed

- ◆ 55 gallon drum (steel is best)
- ◆ 10 large bags of concrete, if low on prep time, add 1 bag of quick set
- ◆ 2 lock boxes per barrel
- ◆ rebar, chicken wire
- ◆ water
- ◆ 5 gallon buckets for mixing cement

### How to make

- ◆ cut 4" diameter circular holes into sides of drum. (or whatever size your lock box is). Figure out where your lockdown persons want their arms. That is where you make your holes. The best way to make the holes is with an acetylene torch- you can usually rent one.
- ◆ You can make the lock box out of steel or PVC. You just need to make a mold that your arm can go through. When using a stump, however, use steel- this reinforces your lockdown. Once they get through the stump itself, they still have to contend with the metal lock box!
- ◆ It is recommended to use two lock boxes so that if they get through one of them, the other person is still independently attached to their own lock box. This way they can't just reach in and unlock your buddy! Just angle the lock boxes so that there is room for two.
- ◆ Mix cement in buckets- stirring constantly. You want oatmeal consistency.
- ◆ Start pouring cement into 55 gallon drum
- ◆ Add rocks
- ◆ Right before the armholes, add the lock boxes.
- ◆ Keep adding cement. But also add rebar pieces going different directions and bits of chicken wire or steel mesh. When you mix cement with metal, you strengthen it. Continue this right to the top.

\* if you are worrying about the cement being dry in time, have the last layer of cement be quick dry. This will give the "appearance" of the thing being solid and hopefully by the time they try and get you out, it will be.

### Armoring

Armor the outsides of your barrel or stump with chicken wire and nails. This is especially important to do when using a stump. Cover every inch !!!!!

- paint your message on the device. Red paint dripping down makes a nice bloody image.

### Moving the thing!

- ◆ A dolly is needed to move the barrels. Load them onto a flat bed truck that can hold a lot of weight.
- ◆ If you are using this device in the city, use a dolly, put a box over it and walk down the street as if you belong there. If you look like you know what you are doing, nobody will question you!

# PVAB

## Portable Vehicle Arresting Barrier

- Reusable
- Non-Lethal deceleration less than 2g's
- Designed to capture 7,500 lb. vehicle at 45 mph with margin
- Demonstrated captures of 14,000 lb. at 35 mph and 20,000 lb. at ~30 mph
- Stopping distance: ~112 ft. for 7,500 lb. vehicle at 45 mph
- Stand-by mode allows for normal traffic flow over speedbump
- System is command activated and deploys in less than two seconds
- Single system is suitable for one and two lane roads
- Setup time: ~40 minutes using expedient anchoring configurations (tactical operations); < 2 hours for buried anchor configuration (fixed facility entrances)
- Permanent installation and wireless activation are available options

### System Capture Mode

- Reset to "stand-by" mode after vehicle capture in ~20 minutes
- Reset to "stand-by" mode in < 5 min after system test or accidental activation
- System can be deployed from 330 ft away

System developed for  OPM - Close Combat Systems,  
Picatinny Arsenal, NJ (973) 724-3457

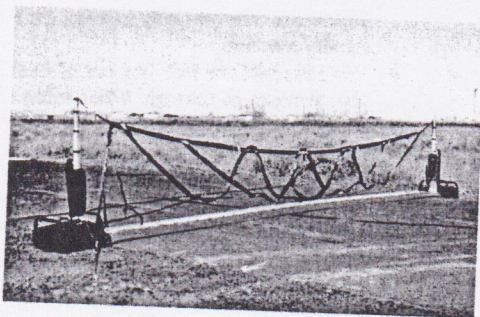
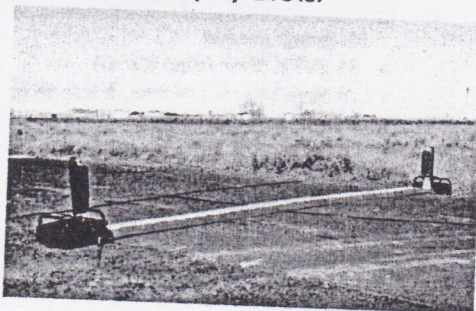

**GENERAL DYNAMICS**  
Ordnance and Tactical Systems

11714 North Creek Pkwy N, - Suite 200 - Bothell, WA 98011 - (425)-420-9311 - [www.gd-ots.com](http://www.gd-ots.com) - approved for public release 12/23/1999  
For additional information, please contact Dave Watt: email: [dave.watt@gd-ots.com](mailto:dave.watt@gd-ots.com)

## BUILDING BARRICADES

Whenever possible, build barricades both inside and outside the doors.

*For the inside.* Use heavy furniture. Distribute it evenly among the doors. Make sure the barricades are actually functional. Don't do anything too complicated or precarious. If pigs are pushing on the barricade from the outside, you should be able to push back from the inside. Do not stack up furniture that can be easily pushed aside once the pigs get through the door (unless you have nothing else). Do not use lock-boxes or chain yourself to anything inside the building.



*For the outside.* An 'outside' team should roll in, build outside barricades and then disperse. Use dumpsters, trees, wood pallets, chain-link fences, picnic tables, luxury cars, and garbage cans filled with rocks to block the entrances. Make sure the outside team knows which door you want to control, so they do not overly barricade it.

*Note on human barricades.* In our first occupation, we relied on human barricades. We got a large crowd to surround the occupied building. They locked arms to protect the doors. But we found that, after a brief period of intimidation, the police left the occupation alone (because the administration wanted to avoid confrontation). Once the police left, the crowd dispersed. Few people stayed all night, especially when there was no immediate threat of police confrontation. It would have been better to get the crowd inside the occupied building. You can trust the physical barricades to protect people inside. Why force the people outside to sacrifice themselves unnecessarily? If possible, have a crowd surround the building during the initial confrontation and then get everyone inside the building as soon as the police leave.

## SECURING DOORS

Doors open either into or out from the space you are occupying. For doors that open into the space, you have only one option: barricade them closed. For doors that open out (most doors in newer buildings), you have many options, depending on what kinds of handles are used to open the doors. Here are some examples.

### CLASSIC METHODS using cable locks:

*Door with turning handles.* Loop one end of a cable lock around the door handle. Tie the other end to a structural support, or loop it around another door handle.

*Doors with push-bars.* If there is no space between the bar and the door, secure a c-clamp to the bar to create a space. Either (1) loop a cable lock through the space OR (2) clamp a length of webbing to the bar. Tie the other end of the cable or webbing to a structural support. If no structural support is available, tie it around a table.

*Doors with no handles.* These are almost impossible to secure without damaging the doors. Unless they open into the occupied space, avoid them.

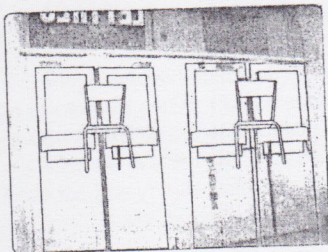

High school occupation during anti-CPE struggle, France 2006

barricading with webbing  
side view

truck tie-down

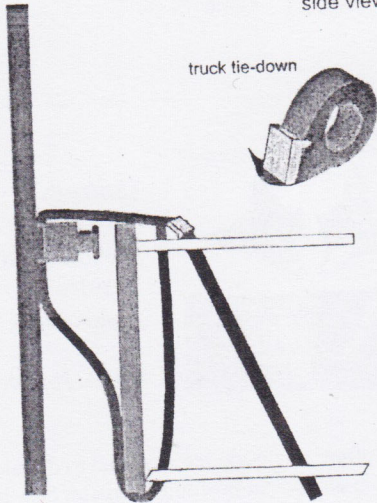

The "bold new" method.  
(All the cool kids are doing it this year!)

### BOLD NEW METHOD using truck tie-downs

*Doors with push-bars.* Get truck tie-downs from the local hardware store. Find ones with ten feet of nylon webbing attached to a metal buckle at one end. Some of these buckles can hold over 1000 pounds of weight. Loop the webbing through the space between the bar and the door (or use a clamp to create that space) and around a table (or anything larger than the door frame). Pull the webbing through the buckle as tightly as possible.

When the pigs try to open the door, the table will not fit through the frame of the door, so the door will not open. If done right, these doors are completely impermeable (unless the pigs can break a window to get in). Use more than one tie-down for each door and make sure there is no give (remember that the nylon will stretch a little bit, so yank on it and readjust). Using tie-downs, two people can carry a table to a door and lock it down in under two minutes.

Make sure the doors are secured as tightly as possible. If the door opens even an inch, the pigs can cut the lock. Use carabiners to tie locks to one another, or to make it easy to open doors without disassembling the locking mechanism. BE CREATIVE: exploit unique door handles!

## CALTROPS

5-36. The caltrop (see *Figure 5-33*, page 5-18) is a field-expedient area denial system. Securing approximately 50 caltrops to 550-type military cord allows a soldier to quickly toss and recover the system. Caltrops are used to deny vehicle and pedestrian movement in designated areas. The four prongs are approximately 2 inches tall and will puncture tires or boots. A soldier can easily employ the caltrop by scattering it in a designated area hidden by camouflage.

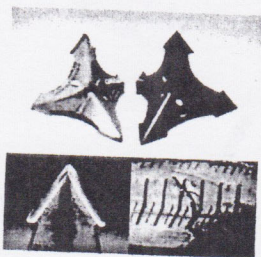

### *Caltrops*

**Manufacturer:** Aardvark Tactical, Inc.

**Vendor:** Aardvark Tactical, Inc.

**Approximate Cost:** \$10.50

**Participating Services:** Army, Marines

**Description:** Caltrops are designed to deflate tires or to deny access to a designated area. They deploy in an upright position no matter how they are dispensed. Caltrops are made from heavy-gauge steel and are powder coated to prevent corrosion.

**Operational Capability/Use:** This tire deflation and antipersonnel device is used as a vehicle barrier. Caltrops cause irreparable, immediate, and catastrophic failure of pneumatic tires. Their "nesting" design allows them to be stacked for storage. "Stringing holes" allow groups of caltrops to be joined with 550 cord or communication wire.

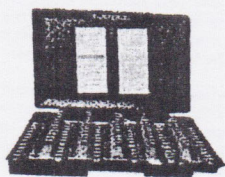

### *Roadside Spike Strip*

**Manufacturer:** Stinger Spike Systems

**Vendor:** Aardvark Tactical, Inc.

**Approximate Cost:** \$475.00

**Participating Services:** Marines

**Description:** The roadside spike strip is designed to be easily transportable and deployable. The spike strip punctures pneumatic tires as the vehicle makes contact. When the vehicle makes contact, the spikes pivot into the tire and the tip guards are pushed down. The spikes become deeply embedded in the tire; they pull out of the unit and remain in the tire. On the second revolution, they are pushed directly into the tire, allowing air to escape slowly without causing a blowout or sudden loss of control. The average tire picks up four to six spikes.

**Operational Capability/Use:** The spike strip deflates tires within 12 to 20 seconds.



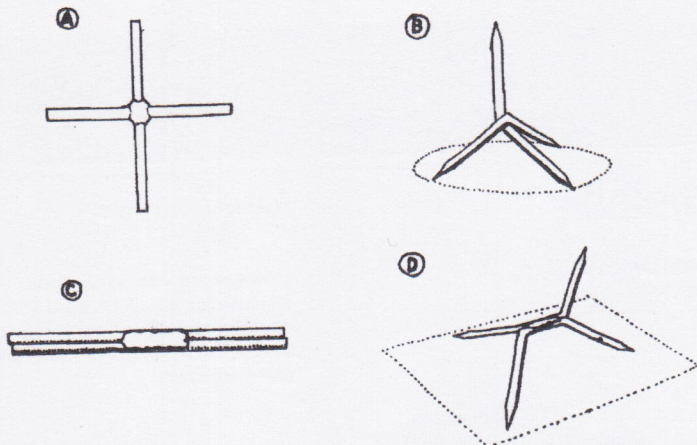

Two possible methods of making caltrops. Top: weld a cross, bend and sharpen. Bottom: weld side by side, bend and sharpen.

\* Somewhat cruder caltrops can be made with inexpensive arc-welding units as small as 70 amps. Sears has a 20-70 variable amp unit that can be obtained as cheaply as \$59. Higher-amperage units are more expensive but will produce faster and more substantial welds. It is important to read the operating instructions carefully before arc-welding and to always use hand and eye protective gear (intense light can burn the retina).

Caltrops can be constructed as follows with the arc welder: Obtain nails, at least 4 inches long, the thicker the better, and cut off the heads with bolt cutters or a hacksaw. Sharpen both ends on a grinding wheel. Extreme sharpness is not necessary as the weight of the vehicle drives the nail into the tire even if somewhat blunt. Weld at least 3 of these nails together in opposing planes so that there is a tripod effect no matter how a thrown caltrop lands.

To perform the actual welding, place one nail in a vise, hold the other in a pair of visegrips, and use your other hand to hold the electrode.

—*Sidewinder*

\* Short on caltrops? Put a caltrop or other sharp object inside a target. Many off-roaders love to drive over the random beer can or paper cup in the road, so put a surprise in one. Those Styrofoam clam-shell containers from fast food places even have a use. One will hold the business end of a broken bottle with its points up. These targets make cleanup afterwards easier and minimize possible injury to animals, hikers, ORVers, and yourself.

\* Effective caltrops can be made with 4 to 6 inch reinforcing mesh used in concreting. This mesh cut at an angle in the middle of each span will produce steel crosses. Bend them at right angles to form quick caltrops.

\* Spray paint caltrops black for use on asphalt so they will be less conspicuous.

\* For simple caltrops, drive a half dozen long nails through a golf ball so that they stick out in all directions. Spray paint the whole thing with a color similar to the surface on which they might be used. Remember that a box of these in your car or truck might look very suspicious to a policeman who, on a random traffic stop, decides to poke around in your vehicle in the hope of finding an open liquor bottle, drugs, or stolen goods.

## Vehicles

### Riot Control Vehicle on GM Silverado Chassis

RC01



### Riot Control Vehicle on MB Chassis

RC02



### Riot Control Vehicle on MB Chassis

RC03

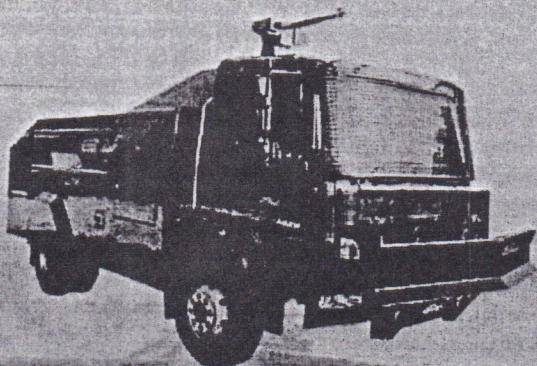

### Mounted LRAD Systems

RC04

Portable systems which could be carried out everywhere, quick installation for all operational vehicles.

Non-lethal technologies highly efficient when dealing with riots.

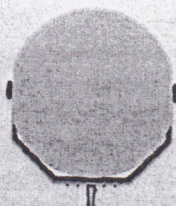
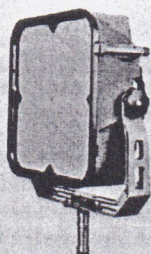

## How to Use the Accessories

**2. Other uses for Spray paint:  
on the windshields of armored trucks and  
on mounted surveillance cameras**



**3. You can also stick a wet towel  
in the vehicle's exhaust to stop it**

**4. You can also throw plastic bags filled with  
liquid soap under the wheels of the armored trucks  
to disrupt their balance as they're moving.**

## Horse & Dogs Equipment

C.P.E. ® has in close co-operation with three police forces developed a new line of horse protective equipment for use in Riot control situations. The Horse Blanket in combination with the hard shell Chest Guard gives the perfect protection. The Nose Guard and face Shield is also needed. C.P.E. ® is proved to also have given the best protection available to different military and police forces using dogs in Riot control situations.





Technology	Rationale
11. Low Energy Laser Scattering and Dazzling	The capability to temporarily obscure an adversary's vision can provide significant military advantage in a number of situations. The use of low power, eye-safe lasers against individuals for this purpose has been proven effective in evaluations conducted during military operations. However, low-power laser technology also has the potential to provide this capability against large groups yielding similar non-lethal operational utility at a larger scale. This can be done by either directly illuminating the adversary group with an eye-safe, broader laser beam or by illuminating an external medium, such as an airborne aerosol cloud, resulting in the scattering of the laser light and creating a "wall of light." Challenges exist in the accurate characterization of effects on the human eye and in overcoming issues of public perception associated with laser technology.



***Dissuader Laser Illuminator***

**Manufacturer:** SEA Technology

**Vendor:** SEA Technology

**Approximate Cost:** \$5,000.00

**Participating Services:** Air Force

**Description:** This handheld laser "flashlight" generates an extremely bright, variable-width beam of red light. The beam is certified eye-safe at all ranges and under all tactical conditions. The laser beam sends a language-independent warning and challenge that forces adversaries to signal their intent to retreat, surrender, or continue aggressive behavior. It dissuades and/or delays adversaries by producing an overpowering glare or flash blinding the individual.

**Operational Capability/Use:** The laser illuminator is suitable for law enforcement missions where revealing a drawn weapon is not advisable. This device can be used as handheld augmentation to sidearms carried on law enforcement missions; use of a sidearm enables quick conversion to lethal force.



DEJAR LAS LUCES ENCENDIDAS

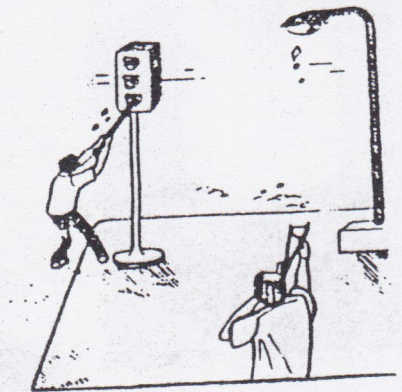
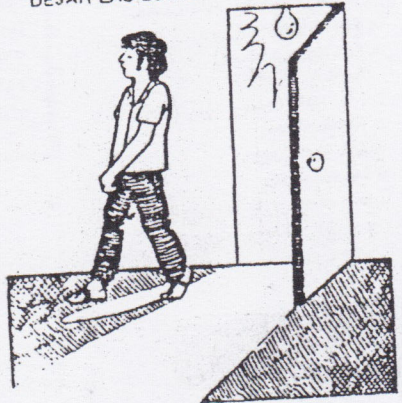

### STANDARD 100 SERIES FEATURES

- Adjustable elasticised side closure for an individual fit
- Front, back and side protection
- Multi-hit capability
- Removable, washable outer cover
- Full freedom of movement
- Water/humidity repellant, fully tropicalised, UV protected ballistic inserts
- Shock/anti-stab plate pockets
- Full range of colours
- Full range of sizes:  
S, M, L, XL & XXL

### OPTIONS AVAILABLE

- Shock plates
- Anti-stab plates
- Trauma packs
- Spare covers & carrying bags

(see page 21 for accessories)

# COVERT OVERVESTS

The LBA Covert Overvest (COV) is designed and supplied with any one of the LBA ballistic inserts. Inconspicuous, issued to diplomats, undercover law enforcement agency officers and press corps.

LBA  
500  
SERIES

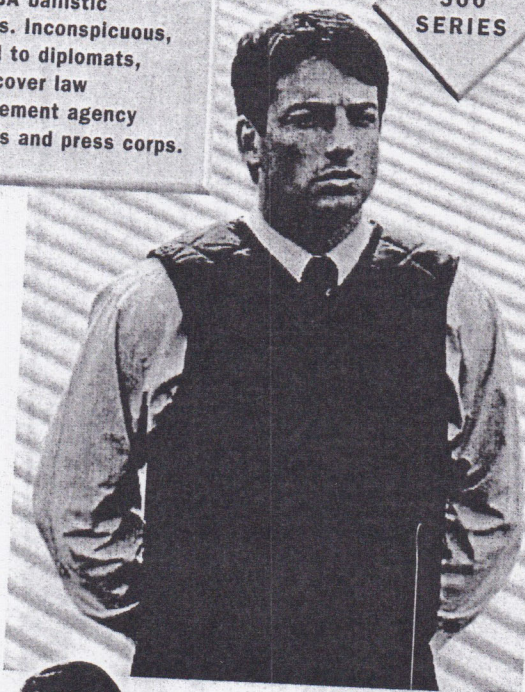

501 - Quilted Overvest

101 - Full Coverage Side Panel Vest

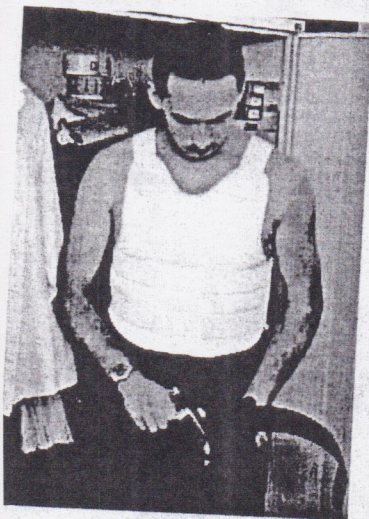

502 - Executive Waistcoat

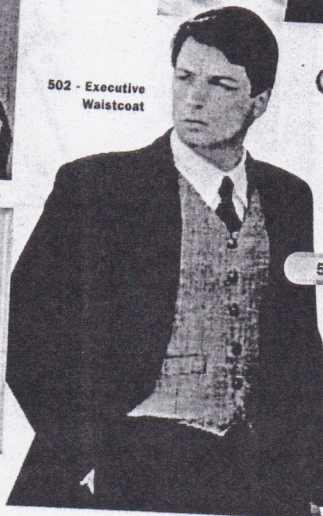

### 501 - QUILTED OVERVEST

The 501 provides the option of wearing soft body armour in a quilted overvest, providing thermal insulation during periods of cold weather.  
Colours: Navy Blue & Olive Drab.

### 502 - EXECUTIVE WAISTCOAT

The 502 EW was designed to meet the demands of executives and diplomats who are, by the nature of their work, exposed to attack in various countries. Only the finest suiting materials are used in the construction of this discreet, inconspicuous personal armour.

### 100 SERIES PROTECTION LEVELS AVAILABLE



NIJ IIA

PSDB HG1



NIJ II

PSDB HG2



NIJ IIIA

## WHO IS AN INFORMER?

There are actually two kinds of informers. The deliberate informer is an undercover agent on the payroll of government or industry. The second type is the activist-turned-informer. Both kinds try to infiltrate our ranks and are equally dangerous to our movements.

Let's discuss the deliberate informers first. They are often difficult to identify. Informers can be of any age and any profile, but they do have a few discernible methods or operation, or "modus operandi". These are:

The "hang around" type: they are persons who regularly show at meetings and actions but generally don't get involved. They collect documents, listen to conversations and note who's who. This observation role is relatively inactive.

The "sleeper" type: is similar to the "hang around" modus operandi, except that their absorption of information is used to activate their role at a later date.

The "novice" type: presents a somewhat more active role, but confines themselves to less prominent work. They don't take initiatives, but the work they do is valued. This helps them build trust and credibility.

The "super activist" type: they come out of nowhere and all of a sudden, they are everywhere. Whether it's a meeting, protest, or an action, this person will be right in the thick of it. Keep in mind however that this can also be the mark of a new activist, whose enthusiasm and commitment is so strong that she/he wants to fight the power every minute of the day.

It should be said that with several of these modus operandi, the behaviour is hard to distinguish from a sincere new person's involvement. How do we tell them apart? Well, a planted infiltrator will ask a lot of questions about the direct action groups, individuals and illegal activities. She/he may suggest targets and volunteer to do reconnaissance as well as take part in the action. Infiltrators also try to build profiles on individuals, their beliefs, habits, friends, and weaknesses. At the same time, infiltrators will shield their true selves from other activists.



organized, and encourage deputies to take a leadership role in Marketing the efforts and image of the Los Angeles County Sheriff's Department.

"Communications and the world have changed, and we must change and adapt too," said Sheriff Baca. "Openness and transparency are now more important than ever to the public and to us. The recent availability of new, inexpensive, and portable communication tools has caused the public to expect us to engage and inform them using these new methods, directly, honestly, and openly."

Some people define public relations and media relations as a method of delivering your agency's message to the public, while one way to look at Marketing is how to draw people in.

As with businesses, Marketing Plans are tools to get organized and ensure you have maximized the reach of your message and not miss your important target markets. For businesses, if they fail at Marketing, they are out of business and out of a job. For law enforcement, there are at least: 8 Great Reasons Why We Should Already Be Marketing Our Sheriff's Departments:

## 1 How well is what we are doing working?

"He who argues for his limitations, gets to keep them," said American author and United States Air Force Fighter Pilot Richard Bach.

For most policing agencies, when we want to inform the public about what we are doing, we prepare a news release, send it to the media, and hope for the best. For many agencies these days, some information can also be found on the official Sheriff's Department website.

Sometimes the media responds well and does what we consider to be a great job, while other times they seem to completely ignore our strong efforts. Meanwhile, whether it is the news media, television shows, or the public using social media, people are talking about policing a lot, because law enforcement is so interesting.

We need to be proactive about getting our message out to the people we serve. They want to communicate with us. The alternative is to keep communicating the way we have always done, and how well has that been working for us?

## 2 If not you, then who?

You are actually already Marketing your Sheriff's office. The day you were told you were going to be hired, you became representative of your agency in the eyes of everyone you new and met. Yet many of us decide that when it comes to media relations, Marketing, or whatever it is called in your area, it is the job of a specialist. In fact, many peace officers

## Marketing Plan Objectives

### A Few Examples

Information about Strategies briefly listed here that work towards the indicated Objectives, can be found at [www.lasd.org](http://www.lasd.org). Importantly, many Strategies work towards the goals of multiple Objectives and their Target Markets.

1. Public - agency website; Instant Communications such as Nixle; Social media such as Twitter and Facebook; Neighborhood Watch and Business Watch; Explorer program; civilian volunteers; Youth programs; VIDA for at-risk youth and Youth Activities League.
2. Media - access and responsiveness; news releases; press conferences; proactive direct messaging and updates.
3. Internal Employees' Perspective - Digital Briefing Boards; eNewsletters and emails; News Clippings Intranet page; internal publications; Deputy Leadership Institute; Education-Based Discipline; Civilian Advisory Committee
4. External Employees' Perspective - Families of employees; Retired deputies email groups and website
5. Law Enforcement Agencies - Publish articles and make presentations, National Sheriffs Association; CA State Sheriffs Assn.; CA Peace Officers Assn.; Peace Officers Assn. of L.A. County; IACP; Regional Community Policing Institute- CA; LACLEAR
6. Justice System Officials - eNewsletters and emails to judges, district attorneys, and public defenders; court information available on website; association publications
7. Public Officials - liaisons and access; eNewsletters and emails; contract city officials conferences
8. External Organizations - Clergy Council; ethnic Community Advisory Councils; civic organizations; activists
9. Vendors - Public/Private opportunities for partnerships; notify of available communications systems
10. Inmates and their Visitors - Inmate Information Center and visiting hours on website; Community Transition Unit; Education-Based Incarceration.

### PRESS RELEASES

Press releases are important to let people know what is going on. If you have done an action and would like to get publicity for it you have several options:

1./ Phone a newspaper or radio station and ask to speak to a reporter. Disguise your voice by stuffing wads of chewing gum between your cheeks and gums, and on the roof of your mouth. Speak clearly, maybe a bit faster than you normally talk. Pinch your nose whilst talking. Do not stay on the phone for too long and hang up if you think they are recording it.  
Call from a public telephone box - extremely important!!

2./ Write a press release.

wear gloves. Use plain paper. Do not lick the stamp or envelope - use a damp sponge. Post it from a post office far from your home to avoid tracing, preferably post it at the CPO.

TELEFONEAR HACIENDO RESERVACIONES FALSAS EN HOTELES, ETC.



DISEMINAR RUMORES

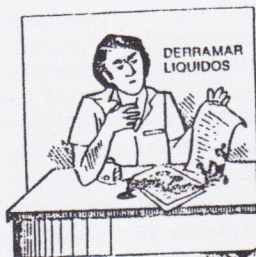
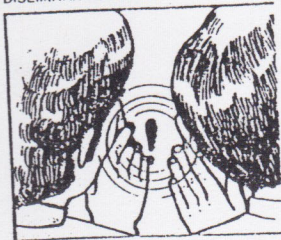

DEJAR CAER MAQUINAS DE ESCRIBIR



AMENAZAR AL JEFE POR TELEFONO

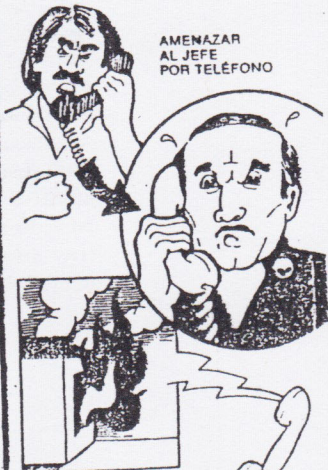

TELEFONEAR DANDO FALSAS ALARMAS DE INCENDIOS Y DELITOS



Officers engaged in civil disturbance operations will be subjected to the noise and confusion created by large numbers of people facing them. Individual officers may be shouted at, insulted or called abusive names. They must learn to ignore these taunts and not allow personal feelings to interfere with the execution of their mission. In addition, officers can expect objects to be thrown at them, but must learn to avoid thrown objects by evasive movements; they must never throw the objects back. Officers must subdue their emotions and carry out their orders determinedly and aggressively whether in formation, patrolling, or posted as guards. They must be emotionally prepared for unusual actions, such as members of the crowd screaming and rushing toward them, tearing off their own clothes, or deliberately injuring or maiming themselves. Officers should understand that the well-disciplined execution of orders is the most effective force applied against rioters. They must be indoctrinated in all aspects of self-control so they may be mentally prepared for participation in civil disturbance operations.

## POST-TRAUMATIC STRESS DISORDER A PRIMER FOR ACTIVISTS

### 10 WAYS TO RECOGNIZE POST-TRAUMATIC STRESS DISORDER

It is normal to get mindfucked when being at a demo. The pigs can be intimidating, and experiencing great amounts of physical damage happening to your comrades - or yourself - can leave a person shaken. Don't fight this, it's incredibly common. Everyone has healing to do, and it's up to you to help your affinity group heal - both physically and mentally. And that includes helping yourself heal. Learn to recognize PTSD and learn techniques to recover.

- 1) Re-experiencing the event through vivid memories or flash-backs.
- 2) Feeling "emotionally numb."
- 3) Feeling overwhelmed by what would normally be considered everyday situations, and diminished interest in performing normal tasks or pursuing usual interests.
- 4) Crying uncontrollably.
- 5) Isolating oneself from family and friends and avoiding social situations.
- 6) Relying increasingly on alcohol or drugs to get through the day.
- 7) Feeling extremely moody, irritable, angry, suspicious or frightened.
- 8) Having difficulty falling or staying asleep, sleeping too much, and experiencing nightmares.
- 9) Feeling guilty about surviving the event or being unable to solve the problem, change the event, or prevent a comrade's injury.
- 10) Feeling fears and a sense of doom about the future.

### *Peer Counselling and Active Listening Information*

Basil prepared these notes for people post Quebec. Thanks for this information, Basil, it has helped a lot of people.

I can't emphasize in words how important it is to be taking care of our mental and emotional health while taking care of our physical wounds. Things like the trauma bonding, PTSD, anxiety attacks, depression, disassociation, etc. will severely limit our ability to connect with hoe and sustain our passions in life and organizing. Despair is a common feeling among activists who have been beaten or gassed by cops, or overwhelmed by the amount of pain, suffering, and oppression in the world. I think that it is necessary to use whatever skills we have to work through our despair - to find healing - and to live life fully. The best (and only) way to stave off PTSD is to talk to your friends and affinity group members. Don't be too proud to ask for help.

## CONCLUSION

- The local population will not go away: serious need to invest in NL capabilities for the future;
  - The use of separate NL launchers from the primary weapon carries unacceptable risks especially if force escalates rapidly;
  - Longer ranges for NLA are required: 100m +;
  - Simple to use: pick up and go;
  - Interoperability is key;
  - Scalable effects highly desirable;
  - Increase cooperation between Law Enforcement, Industry, Academia & Military; and
- National & International Issues.**



The Land Staff / L'état-major de l'Armée de terre  
Major Stéphane Dufour (R22eR), Land Requirements

20/21

26 Nov 09

These are a few of the most probable situations and suggestions of possible tactics to deal with them. Keep in mind that although the police are trained to fight and deal with you, they are just doing their job and following orders. Watch for their weak points and times that they are vulnerable, such as during shift changes or while they are waiting for the order from above. The best preparation before going into possible situations is discussion and communication with your peers. Don't get preoccupied fighting the cops and remember your original target. Don't let the stress level lead to infighting; that's exactly what they want to see. Maintain solidarity with your fellow protesters and recognize your common goal to keep yourselves from getting arrested or getting hurt.

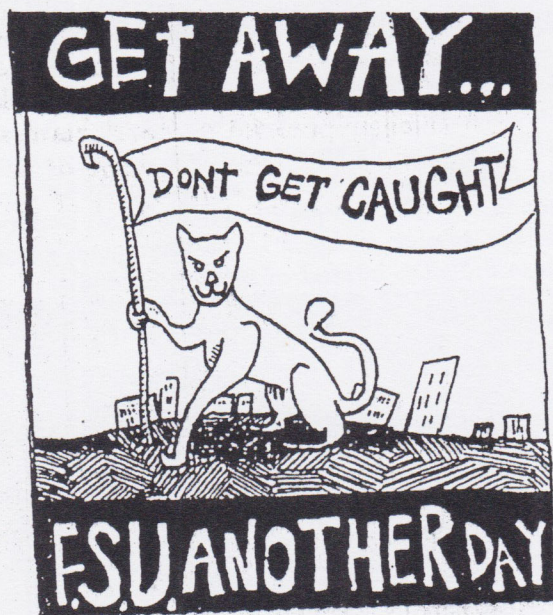

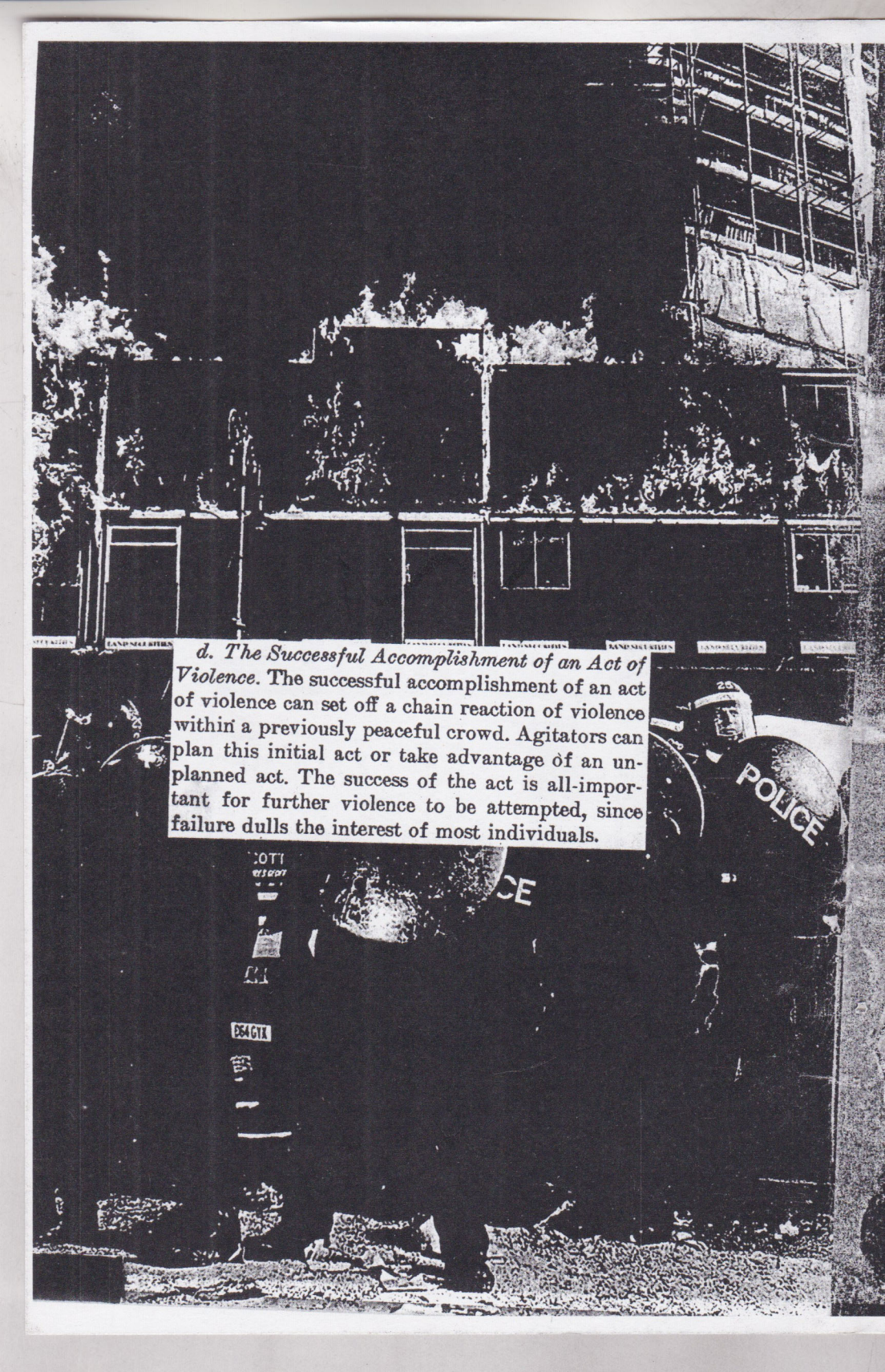

*d. The Successful Accomplishment of an Act of Violence.* The successful accomplishment of an act of violence can set off a chain reaction of violence within a previously peaceful crowd. Agitators can plan this initial act or take advantage of an unplanned act. The success of the act is all-important for further violence to be attempted, since failure dulls the interest of most individuals.