

**TECHNICAL STUDY
FOR REHABILITATION
ON PRAMBANAN TEMPLE COMPOUND
AFTER EARTHQUAKE**

**BY
TECHNICAL STUDY TEAM
ARCHAEOLOGICAL OFFICE OF YOGYAKARTA**

ktorat
yaan

**DEPARTMENT OF CULTURE AND TOURISM
2007**

THE FORMATION OF TECHNICAL STUDY TEAM FOR REHABILITATION ON PRAMBANAN TEMPLE COMPOUND AFTER EARTHQUAKE

ADVISOR :

Drs. Hari Untoro Drajat, MA
Drs. Soeroso M.Hum .
Drs. Agus Waluyo

TEAM LEADER :

Dra. Ari Setyastuti, M.Si

EXPERT :

Prof. Dr. Ir. Kabul Basah Suryolelono, Dip.H.E, D.E.A.
DR. Inajati Adrisijanti Romli
Ir. Ismoyo
DR. Subagyo Pramujiyo
DR. Sismanto
Dra. Herni Pramastuti

EXPERT ASSISTANT:

Andi Putranto, S.S.
Ir. Suprpto, Ph.D.
Dr. Ir. Ahmad Rifa'i, MT.
Dr. Ir. Agung Haryoko, M.Sc
Eddy Hartantyo, M.Si
Drs. Indra Dewa Kusuma

SURVEYOR and DATA PROCESSOR :

Darmojo
Saridjo
Karbino
Jumino
Bunyakın
Lukito
Sumardi
Supriyono
Suraji
Suwito
Sabar
Titik Retnowati

STUDIO :

Murianto Harjuno, BA
Dewi Puspito Rini, SS
Aris Munandar
Alam Yudha Utama, SIP

CONTENT

PREFACE	1
I. INTRODUCTION	2
II. THE HISTORY OF THE RESTORATION	5
III. FINDINGS DURING THE TECHNICAL STUDY	8
A. Damage on the Structure	8
B. Damage on the material	12
C. Excavation	14
D. Geoelectrical Mapping and Seismic Refraction Survey in Prambanan Temple	17
E. Geo-electric, geotechnical, and geo-radar test	24
F. Geology of Prambanan Area	30
1. Geology of the Prambanan Temple Site	30
2. Seismicity of the Prambanan Temple Site	34
IV. DAMAGE ANALYSIS	35
A. Analysis on Temple Structure	35
B. Material Damage	40
V. RECOMMENDATION	42
REFERENCES	45
APPENDIX	

PREFACE

Thanks to God almighty, the technical study on rehabilitation of Prambanan complex after the earthquake 27 May 2007 has been successfully finished. Prambanan temple complex as one of the world heritage site suffers damages after the earthquake. To rehabilitate the temples, some comprehensive technical studies which involve some disciplines are needed to carry out. This report is the compilation of the studies results which covers damage observation, geotechnical (using machine drill) investigation, geoelectric investigation. This report is also a preliminary study which can be used as a recommendation to conduct a further study and rehabilitation project. Finally, a thank goes to all the team members in finishing this report.

Yogyakarta, March 2007

Head of Archaeological
Office Yogyakarta

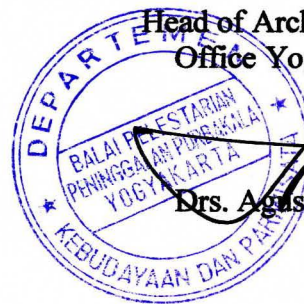

Drs. Agus Waluyo

I. INTRODUCTION

Early morning on Saturday 27th of May 2006 on 05.55 a.m. the area of Yogyakarta and a part of Klaten (Central Java) experienced a 5.9 Richter scale earthquake for only 55 seconds. The epicentrum was in the beach 37 km south of the city of Yogyakarta, on 8.4 South Lattitude and 109.95 East Longitude, 5 km beneath the earth surface. The impact was very destructive. Thousands lost their life, buildings destroyed, roads cracked. Even heritages e.g. temples, sultan's palace, ancient city wall, ancient tombs, traditional houses, experienced heavy damages.

Prambanan temple compound as one of the World Heritage (no. 349 in the 1991 List which was renewed in the 1998 as no. 642) also experienced heavy damages. Similar condition were also experienced by many other temples in the region around Prambanan. This region is famous for having the greatest wealth of heritages from the Early Indonesian Classical Period (IX – X AD). Besides Prambanan temple compound, there are other temples either Hindu or Buddhist ones, e.g. Lumbung temple, Bubrah temple, Sewu temple, Plaosan temple, Sojiwan temple, Kalasan temple, Sari temple, Sambisari temple etc.

According to geology's point of view Prambanan region is situated above the fault that spreads out from a point south of the city of Yogyakarta towards the north-east area of Prambanan region. This fault is called Opak Fault, which is still active yet. The impact of the earthquake to the abovementioned heritages are structural damage, e.g. slanting, collapse, vertical and horizontal deformation, crack; and material damage, e.g. crack, broken, and peeled off.

Emergency steps in overcoming the destructive effect of the earthquake have been conducted by doing some activities, such as prohibiting the tourists to enter the temple compound, increasing the security around the temples, making publication and socialization on the condition of the temples after the earthquake, forming team to observe the damage. We also coordinated with many local, national, and international institutions especially UNESCO since Prambanan temple compound is one of the World Heritage.

For Prambanan temple compound rescue activity was conducted since the end of May 2006 up to September 2006. Activities done during that period were : making every type of documentation, detail observation on the damage on the temples in the compound, clearing up the components of the temple that fell down in the temple floor and the courtyard, and dismantling the components whose position are dangerous.

There are individual characteristics on the damage on each temple in Prambanan compound in accordance with the restoration method conducted previously. But, generally the damage experienced by those temples are material and structural ones. Material damage consists of cracks, broken, and fragmented, while structural damage consists of vertical and horizontal cracks, and collapse. The result of the observation were still in preliminary phase, considering the presence of the aftershocks, and the hindrance caused by the scattering of the fallen temple components, and the dangerously situated components of the temples.

After the rescue activities were done, the next step is conducting a minute and interdisciplinary observation to formulate detail and comprehensive plan for the recovery activities. Hence we make a technical study involving experts in archaeology, civil engineering, geology, geophysics.

The recovery activities on Prambanan temple compound need to be conducted immediately considering its role as one of the World Heritage, one of the important cultural heritages of Indonesia, and one of the main tourist destination in the world and in Indonesia. The damage caused by the earthquake decreasing the tourism income up to 50%. It is a significant amount for people whose living depends on many sectors of tourism. In macro insight the decrease also makes a degradation of Indonesia's foreign exchange from tourism sector. While in micro insight the decrease significantly influencing the economy of the local community. Therefore the restoration of Prambanan temple compound will rise the tourism activities which in its turn will give an multiplier effect to increase the economic development of the community.

Objective and Target

Temples in Prambanan complex after the earthquake suffers some damages. The damages influence the strength of the temples. Cracks, structure sinking and structure lining occur in some parts of the temples in Prambanan temple complex. Considering the damages, observation and detail damage mapping are needed to carry out on each temples. The results of the observation and mapping are useful for the technical study which can be used as a recommendation to formulate the recovery planning. The observation and damage mapping is aimed to collect a qualitative and quantitative data on the damages. The data is also useful to observe the strength of the temple structures. The strength of the structure is a fundamental factor which must be considered dealing with the conservation of the temple. Considering the fact above, the strength of the temple structure must be observed before conducting the rehabilitation phase. The objective of the technical study on Prambanan temple complex is to collect technical and archaeological data which is useful to formulate the rehabilitation on the material and structural damages. The technical study involves experts from some disciplines.

The technical study is carried out on the three main temples. They are Wisnu, Siwa and Brahma temples. The targets of the task are:

1. Observation on material and structural damage qualitatively and quantitatively
2. Damage mapping
3. Formulation of the recovery task
4. Formulation of budget plan on recovery phase

Expected outcomes

1. Formulation of recovery task guideline.
2. Formulation of action plan on rehabilitation for short, mid and long terms budget estimation on recovery phase.

II. THE HISTORY OF THE RESTORATION

Prambanan temple compound was rediscovered on 1733, as a ruin with shrubs and trees grew on it. On 1885 Dr. Ijzerman a Dutch archaeologist and historian tried to bring order to the compound. But, he, and later Groneman, told the local workers to remove all of the fallen stoneblocks, and put them into a large pile placed on the west of the temple. In 1902 and on 1903 the first step to do a real restoration just begun led by Van Erp. He began restoring the subsidiary chambers of Siwa temple. When De Haan took over the work on 1926 the idea of complete restoration took root. But, the proper reconstruction commenced at the end of 1937. They estimated that the work on Siwa temple could be finished by 1945.

Based on the report written by V.R.van Romondt, several numbers of *Oudheidkundig Verslag*; and Jordaan (1996:172-190) we know how the restoration on Siwa temple was conducted. The first step was an enormous sorting and sifting operation out of the huge pile of the fallen stoneblocks, according to their size, shape, and characteristics of the details. Meanwhile, reconstruction plans were made. The stoneblocks were, then, assembled in sections as trial reconstruction. The indication on the pairing of the stones was they underwent individual treatment, so they have idiosyncratic characteristics. They were joined e.g. by tongue – groove, and swallow-tail joints.

After that, the actual work of reconstruction begun by buying and making timber scaffolding. The restorer realized that absolute accuracy in the reconstruction was compelled, meanwhile the trial reconstructions were dismantled. The fragments which had flaked off were put back in their original positions with rust-free metal. Later, the stoneblocks were piled carefully, without the addition of any mortar. After which the joints were filled with an extremely liquid variety of cement (one part of cement to one part sand), or with pure cement water in the case of very narrow joints.

In the reconstruction the use of iron was avoided in places where it will be exposed to the open air. The iron ducts that had been added to the galleries during the previous reconstruction were replaced by reinforced concrete. The iron girders that had been placed under the thresholds were replaced also by reinforced concrete constructions in the threshold. The iron wall-ties, by which the external wall was attached to the additional

concrete mass, were provided with extra cement in order to prevent corrosion. To make it not costly, they kept the concrete thin and the rest of the interior work was carried out with the usual river stone masonry.

The restorer realized that Prambanan compound stands on earthquake-prone area. They thought that if the temple was shaken by earthquake, only incredible heavy structure would be proof against the earthquake. Therefore the outer wall was protected against detachment from the central body during severe earth tremor by a concrete skeleton consists of a construction of horizontal circular beams and vertical columns. The broken threshold were strengthened by reinforced concrete joints. The stone slabs of the passageways were laid on reinforced concrete floor.

But, during the Second World War and the Struggle for Independence of Indonesia the restoration work stopped, even many technical drawings and photos were damaged or lost. After the Independence, exactly on 1949, the restoration work was just begun again. Archaeological principle demands a clear distinction should be made between the original and the renewed stone components. Therefore the new stone blocks were furnished with lead seal. On 1953 the restoration of Siwa Temple , the main temple in the compound, was declared completely done by President Soekarno.

Later, the other temples in the main courtyard of the compound were restored. They were Brahma temple on 1978 – 1987, Wishnu temple on 1982 – 1991, three Wahana temples and eight Patok temples on 1991 – 1993. During the restoration of the temples reinforced concrete columns and circular beams were also used, which were inserted inside the temple wall. The circular beams were placed inside the foot, the gallery, the base of the body, and the roof. Brass wall-ties were used to attach the external wall to the additional concrete mass. To prevent straight contact between the back side of the outer stone and the additional concrete, the stone were provided with araldite tar in order to prevent corrosion.

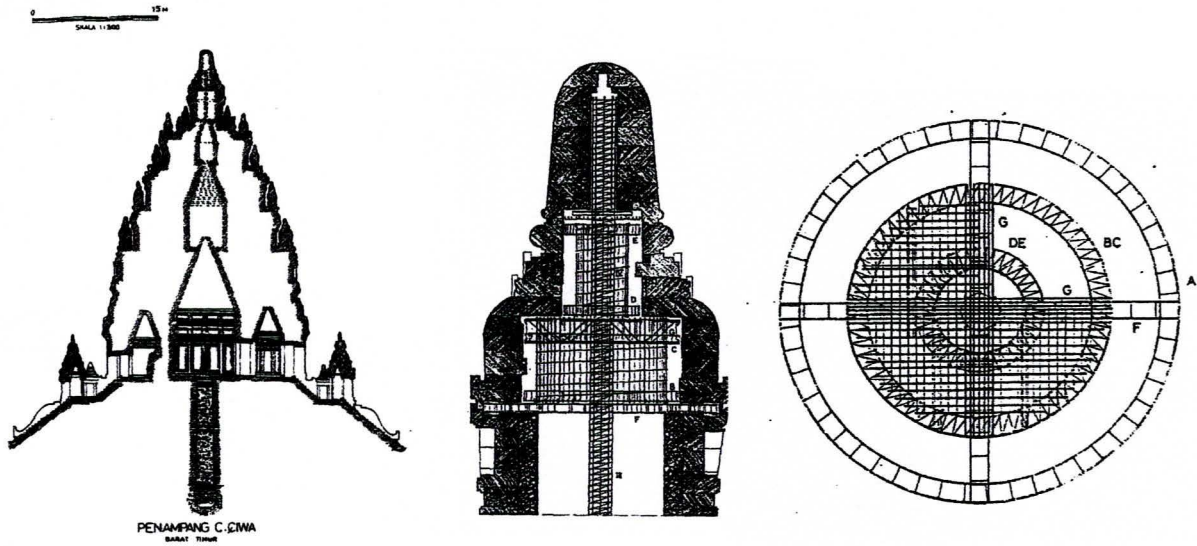

Reinforced concrete construction on Siwa temple

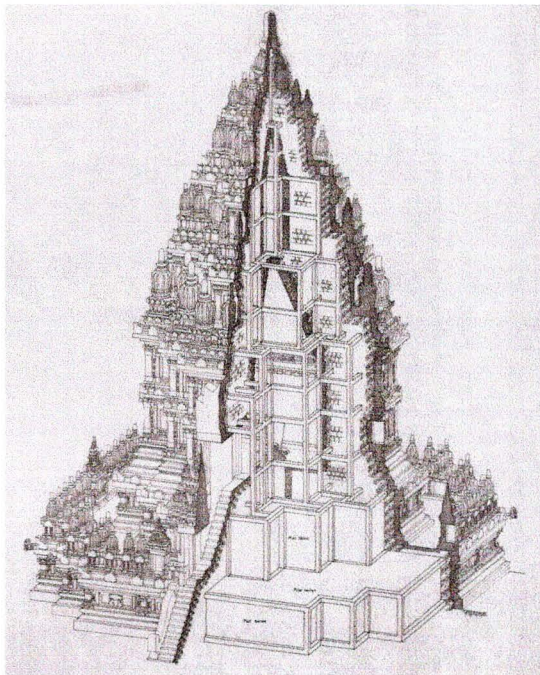

*Brahma temple concrete framework
isometrisch*

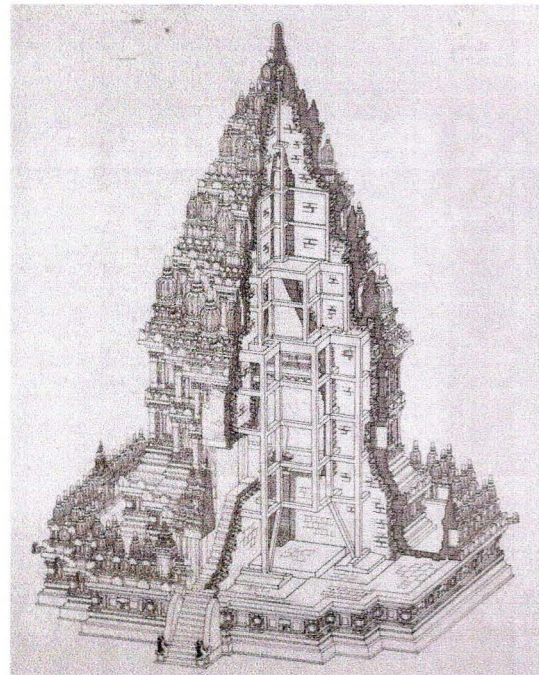

*Wisnu temple concrete framework
isometrisch*

III. FINDINGS DURING THE TECHNICAL STUDY

A. Damage on the Structure

According to the observation done during technical study, structural damage on the temples in Prambanan temple compound are: sink downwards, horizontal move, and vertical and horizontal cracks. The damage varies among the temples. It is assumed to be influenced by the restoration method in the past, and the variety of the shocks.

The restoration method before 1980: the open joints among the stone blocks were cast using liquidated cement, the use of iron wall ties, the use of reinforced concrete columns and beams. Therefore, the stone structure of the temple became massive and rigid.

The restoration method after 1980: the use of reinforced concrete columns and circular beams which were inserted inside the temple wall, brass wall-ties were used to attach the external wall to the additional concrete mass, and the use of araldite tar to prevent corrosion. Therefore, the stone structure was not massive, and flexible.

There was cracks on the soil surface of the main courtyard of Prambanan temple compound. The cracks were found on the east of Brahma temple 15 m long, and the west of Garuda temple 5m.

The types of structural damage are : sink downwards, horizontal move, and vertical and horizontal cracks. On Brahma temple there are sink downwards about 2 cm at the east staircase towards the south-east as far as the 1st – 5th and the 20th sections. The sink down is accompanied by vertical and horizontal cracks. Horizontal move occurs at the balustrade and the doorway, third and fourth stories of the roof. There is also twist caused by cracks, and horizontal and vertical cracks.

On Siwa temple the sink down occurs at the four stairways, about 2 cm deep. It makes horizontal crack on the balustrade doorway, exactly between the body and the roof of the doorway. Horizontal and vertical cracks occurs from the foot of the temple through the floor, up to the body of the temple. The cracks can be observed on the whole 30 sections. There is a significant crack that encircles the lower body of the temple, from the 1st to the 20th plane. This crack is accompanied by horizontal outward move about 2 cm – 5 cm.

On Wisnu temple the sink down presents on the foot of the temple, exactly on the 6 and 7 planes on the south side, about 2 cm deep. Horizontal move occurs on the balustrade, on the floor, and the top of the foot. It is accompanied by twisted crack and slanting toward the outside. The horizontal move on the floor is about 0,5 cm to 5 cm.

**DATA OF STRUCTURE DAMAGE
BRAHMA TEMPLE**

No	Components	Section	Type of damage (block)			Note
			Collapse	Horizontal	Vertical	
1	Basement I	1 - 20	1	24		
2	Ballustrade	1 - 20	20	14		
3	Gate		2	1		Has dismantled
4	Stairs (side)		-	8		
5	Inside balustrade	1 - 20	3	21		
6	Walohan	1 - 20	-	21		
7	Basement II	1 - 20	1	6		
8	Gallery	1 - 20	52	-		
9	Yard	1 - 20	84	-		
10	Roof					
	I		4	14		ratna
	II		14	3		ratna
	III		41	2		antefik
	IV		187	-		
11	Ratna (Center)		62	-		
12	Body					
	Roof I		1	-		
	Roof II		-	-		
	Roof III		102	-		
13	Chamber					
14	Chamber's floor					
15	Gallery's floor					
	Total		574	114		

**DATA OF STRUCTURE DAMAGE
WISNU TEMPLE**

No	Components	Section	Type of damage (block)			Note
			Collapse	Horizontal	Vertical	
1	Basement I	1 - 20	-	53		
2	Ballustrade	1 - 20	3	66		
3	Gate	1 - 20	-	56		Has dismantled
4	Stairs (side)	1 - 20	2	8		
5	Inside balustrade	1 - 20	4	6		
6	Walohan		-	-		
7	Basement II		-	-		
8	Gallery	1 - 20	6	-		
9	Yard	1 - 20	45	-		
10	Roof					
	I		1	1		ratna
	II		4	2		ratna
	III		1	1		ratna
	IV					
11	Ratna (Center)		-	-		
12	Body					
	Roof I		-	-		
	Roof II		-	-		
	Roof III		-	-		
13	Chamber		-	-		
14	Chamber's floor		-	-		
15	Gallery's floor		-	-		
	Total		66	193		

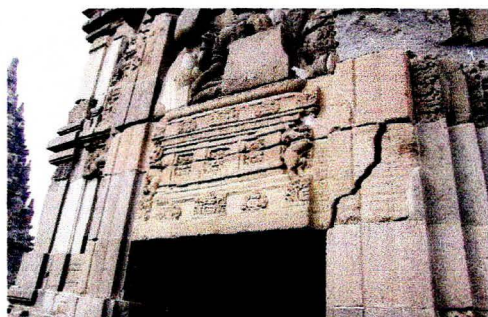

Cracks on the outer wall and alley of west gate way of Siwa Temple.

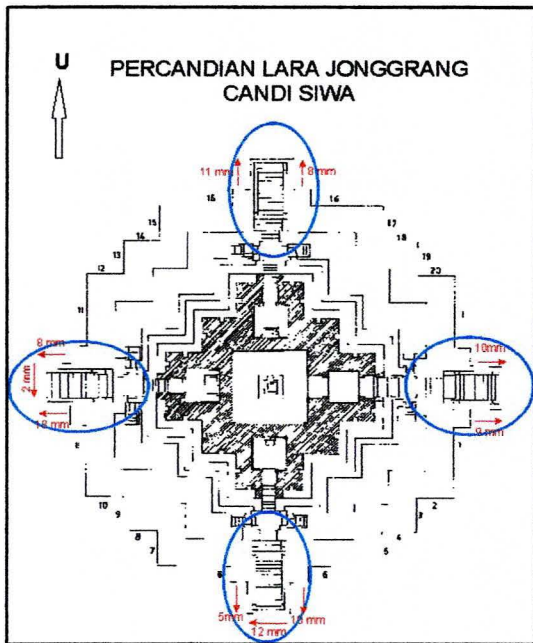

Siwa Temple

DEFORMATION

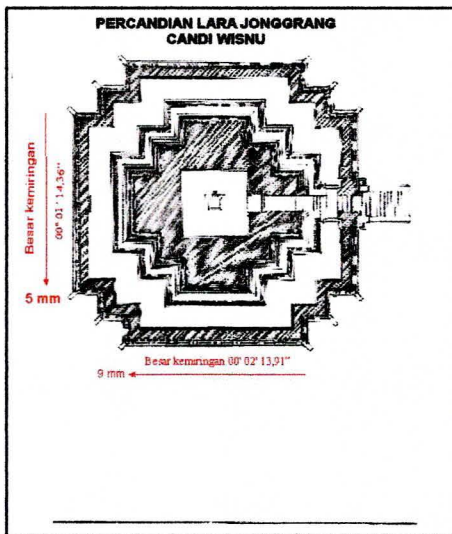

Wisnu Temple

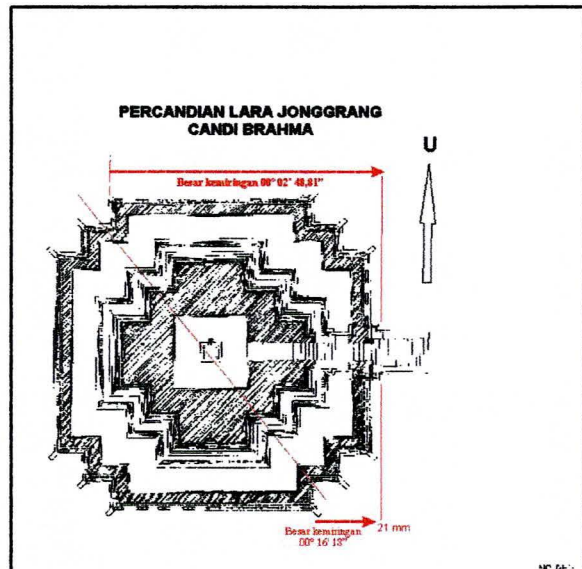

Brahma Temple

B. Damage on the material

Generally the damage on the stone blocks are: cracks, broken but still in situ, and fragmented. The object of the observation are: the fallen components of the temples, either on the courtyard, on the floor of the balustrade or the still-in-situ stone blocks. It turns out that the heaviest damage on the building material occurs in Brahma temple. There are many components of the roof which fell down and are broken. On Brahma and Wisnu temples many stone blocks are broken, because stoneblocks from the upper stages fell on them. On the other hand the damage on the building material of Siwa temple are mostly cracks on the stone. It seems because the space among the stoneblocks were filled with cement, they became monolithic structure.

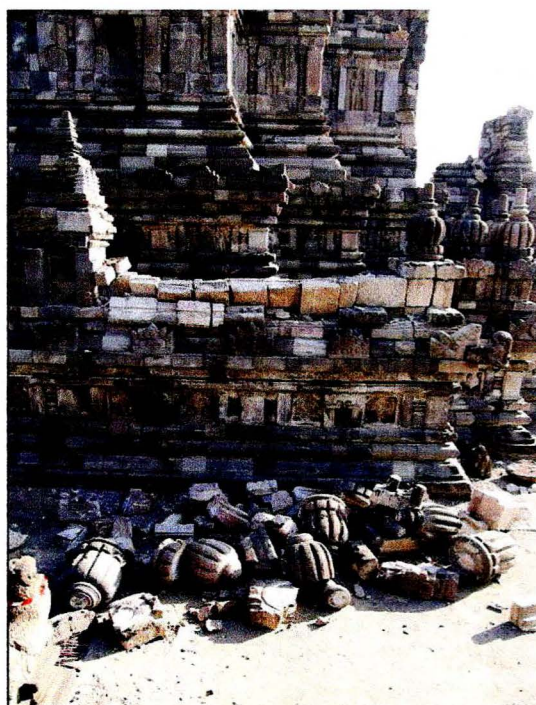

Material damage on Brahma and Wisnu temple

Data of material damage on Siwa temple

No	Components	Section	Type of damage (block)			Note
			Cracking	Breaking	Fragment insitu	
1	Basement I, Body II and Chambers floor	1 - 20	1504	847 #	20 *	* Missing # Fragment still insitu
2	Yard			1		Pecah menjadi 18 fragmen
3	Roof					
	I		20**			** Crack on the mortar epoxy
	II		15**			
	III		6**			
	IV		-	-	-	

Data of material damage on Brahma temple

No	Components	Section	Type of damage (block)			Note
			Cracking	Breaking	Fragment insitu	
1	Basement I	1 - 20	26	15	11	
2	Outside ballustrade	1 - 20	3	-	15	
3	Gate		-	1	4	
4	Stairs (sides)		5	2	17	
5	Inside ballustrade	1 - 20	27	23	49	
6	Walohan	1 - 20	5	2	19	
7	Basement II	1 - 20	20	7	27	
8	Gallery	1 - 20	-	161 *	149*	*storage
9	Yard	1 - 20	-	301 *	52*	*storage
10	Roof					
	I		3	16	30	
	II		3	7	13	
	III		3	8	18	
	IV		-	-	5	
11	Ratna (center)		-	-	2	
12	Body					
	Roof I		-	-	-	
	Roof II		-	-	-	
	Roof III		1	20	9	
13	Chamber		-	-	-	
14	Chambers floor		-	1	-	
15	Galleries floor		11	54	-	
	TOTAL		107	618	420	

Data of material damage on Wisnu temple

No	Components	Section	Type of damage (block)			Note
			Cracking	Breaking	Fragment insitu	
1	Basement I	1 - 20	56	27	26	
2	Outside ballustrade	1 - 20	4	10	6	
3	Gate	1 - 20	13	16	21	
4	Stairs (sides)	1 - 20	-	-	2	
5	Inside ballustrade	1 - 20	6	17	17	
6	Walohan		-	-	-	
7	Basement II		-	-	-	
8	Gallery	1 - 20	-	201*	20 *	* storage
9	Yard	1 - 20	-	67*	9 *	*storage
10	Roof					
	I		--	-	3	
	II		2	-	-	
	III		-	-	-	
	IV		3	-	-	
11	Ratna (center)		-	-	-	
12	Body		-	-	-	
	Roof I		-	-	-	
	Roof II		-	-	-	
	Roof III		-	-	-	
13	Chamber		5	1	-	
14	Chambers floor		-	1	-	
15	Gallerys floor		3	24	-	
	TOTAL		92	364	102	

C. Excavation

All restoration projects on the archaeological remains are always preceded by study to formulate and to decide the treatment strategies which are suitable with the problems. Effort which has a connection with the formulation of the strategies is excavation. The excavation is conducted to collect some data. Dealing with the problems which occur in Prambanan temple complex whereas most of the temples have heavy damages structurally and architecturally, excavation must be conducted on some locations to collect supporting data. The data is useful for technical study on structural damages in the temple building.

Excavation is located spatially on the basement of Brahma, Siwa and Wisnu temple. The aim of this project is to observe the structure damage (crack and deformation

on stones) on the basement which can not be observed visually. The excavation is needed considering the condition of the basement can not be observed without digging the soil near then basement.

The excavation opens six holes in some locations. The locations are:

Brahma temple

- Hole III/b I/l XXIV in the southeast temple corner
- Hole III/b I/s XV in the northwest temple corner

Siwa temple

- Hole III/b I/u IX in the southwest temple corner
- Hole IV/a 1/i 6 and hole IV/a 1/h 6 in the northeast temple corner

Wisnu temple

- Hole IV/a 2/u 22 in the northwest temple corner

1. Hole III/b I/l XXIV

This hole is dig considering the occurrence of the crack on the stone structure which can be observed from the southeast corner to the basement of the temple. The hole measures $2 \times 2 \text{ m}^2$ while the depth of the hole is 240 cm. The north wall of the hole is lime stone structure, the part of the temple basement. The lime stone structure on this level consists of 4 (four) levels. The soil consists of soil which mixes with sand and lime stone gravel. It is assumed that the gravel derives from the basement-making residue.

2. Hole III/b I/s XV

This hole is dig base on the same consideration with the previous hole. The different is only on its location. Considering the crack also occurs in the northwest temples corner, an excavation is needed to conduct in this location. The hole measures $2 \times 2 \text{ m}^2$ while the depth of the hole is 245 cm. The south and west walls of the hole is lime stone structure which the part of the temple basement. The a lime stone structure consists of 4 (four) levels. The soil in this depth consists of soil which mixes with sand, lime stone gravel and andesite gravel.

3. Hole III/b I/u IX

Although the same type of cracks which occur in southeast and northwest of the temple's body and basement does not occur in this location, an excavation is needed to be conducted to ensure that the damages do not occur on this location. This excavation is the first excavation project which is conducted on the basement Siwa temple. The hole measures 2 x 1 m² while the depth is 63 cm. On the depth of 40 cm, pottery is found. The pottery is tied with a red and black thread. The excavation also finds some old coin (kepeng). The analysis result states that the pottery and the coin are new discoveries. The west wall is an andhesite stone structure which consists of 2 (two layers). The soil consists of soil which mixes with sand and andhesite stone gravel.

4. Hole IV/a 1/i 6 and Hole IV/a 1/h 6

This hole is dig to expose the condition of the structure basement similar with the hole III/b I/u IX. The different is only the location. The damage which can be observed on the temple basement is crack on the space between stone blocks. The crack occurs along the basement. The hole measures 2 x 1 m² while its depth is 187 cm. The south and west wall of the holes are a andhesite stone structure (two level) and a lime stone structure of the temple basement. The lime stone structure consists of 2 (two) level. The base of the hole, there are some stone arrangement which is used to strengthen the temple's basement. This data shows that Siwa temple's basement has a different type from Brahma temple's basement. Its lime stone blocks arrangement in the basement structure of Siwa temple are wider than on the Brahma temple. On Brahma temple's basement, the lime stone structure is arranged vertically with the andhesite one.

The other interesting phenomenon is that one level of andhesite stone layer on the basement is arranged stood out compare with other levels. In Brahma temple, stone structure which is used to strengthen the temple's basement does not exist. It is assumed that it is dealing with the dimension of the temples. Siwa temple has a longer, bigger and higher dimension than Brahma and Wisnu temples. Siwa temple also heavier than the two temples. The types of soil in this hole are soil mix with sand, lime gravel and andhesite gravel (dominants).

5. Hole IV/a 2/u 22

This hole is dig to expose the condition of the temple basement. The excavation can show the structure condition dealing with the damages on the basement and the body of the temple. The hole measures 2 x 2 m² while its depth is 65 cm. The basement of this temple is similar with Siwa's. One level of andhesite stone layer on the basement is arranged stood out compare with other levels. Under the stood out level consists of 2 (two) levels. The lime stones arrangement is found under the two levels. This arrangement is functioned as the foundation.

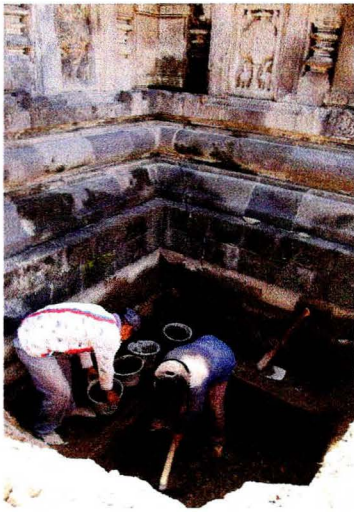

Excavation on Brahma Temple



Excavation on Siwa Temple

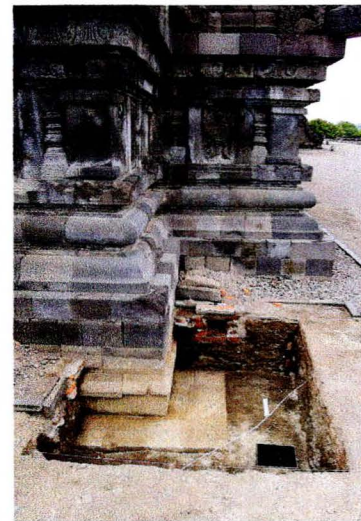

Excavation on Wisnu Temple

D. Geoelectrical Mapping and Seismic Refraction Survey in Prambanan Temple

1. Seismic Method

The seismic method is one of the most practical and convenient method to determine subsurface geological condition and mechanical properties. By inference from the propagation velocity; attenuation and wave shape of a propagating wave, we can indices important characteristic of *in situ* rock and soil.

The refraction seismic surveys use a source of wave energy (hammer) and some geophones to record the refraction wave that emerge on the surface. From the first break

of the refraction wave at each geophone, we can make a time-distance curve that lead to estimate the velocity and depth of the refractor layer. The refractor layer is indicated by difference velocity and characteristic of *in situ* rock or soil. Hagiwara and Mashuda method had been to estimate the interface depth and velocity.

2. Geo-Electric Mapping

The geo-electrical mapping is a non-destructive survey to know the resistivities distribution of the soil laterally. The procedure proposed by injecting DC electrical current into the ground, and then measures the voltage on the surface by double potential electrodes at in line position. The configuration system of in line position is dipole-dipole arrangement. The processing and the modeling use RES2DMOD and RES3DMOD. Two points are conducted by vertical electrical sounding (VES) in Schlumberger configuration to know the resistivities distribution of soil vertically. The data processing uses Progress 3.0 software.

3. Data acquisition

The acquisitions of geo-electric and seismic data are carried out in January 16-17, 2007. Five seismic and geo-electric lines are shown in Fig.1, i.e., US-1, US-2, US-3, TB-1, and TB-2, two points S1 and S2 are the vertical electrical sounding (between Siwa and Nandi temples).

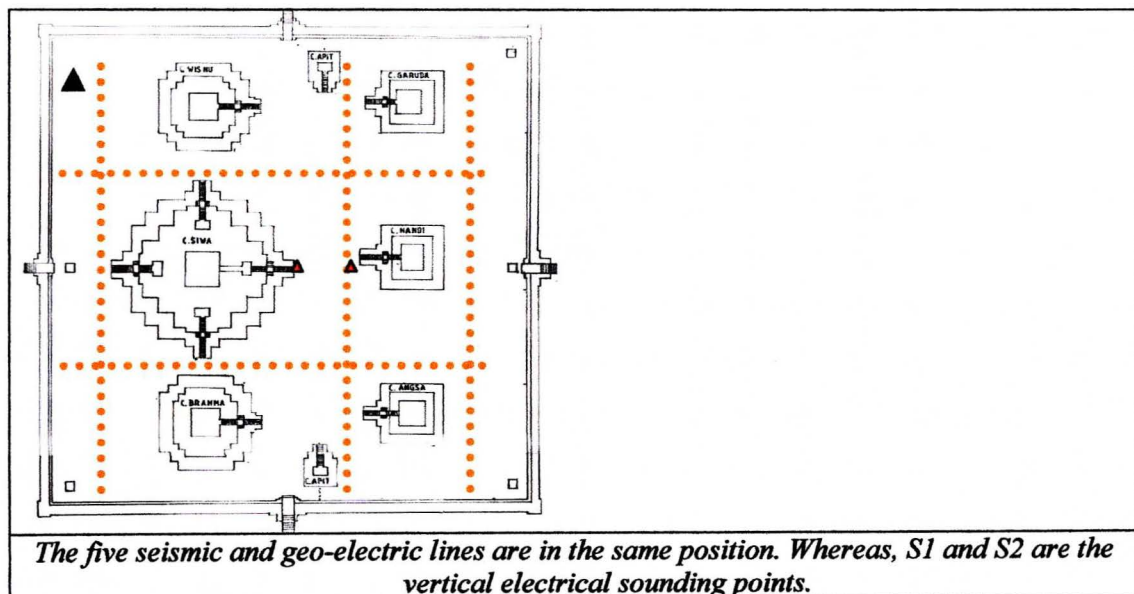

4. Geo-electrical Survey Result

Resistivity distributions of dipole-dipole configuration for difference depth are shown at Fig.2. This area indicates that there are a low resistivity zones (in blue color). The depth of the anomaly is 2m to 8m; physically it may caused by wet soil. According to Izjerman, in the Prambanan temple vicinity there is much drainage system to absorb the surface water until 5.75 m deep of wet soil under the floor (Jordaan, 1996). The anomalies (low resistivity zone) are interpreted as drainage system infiltration in the subsurface. Meanwhile, the high resistivity zone depth is about 7 to 8 m (the red one). The high resistivity zone indicates the hard rock layer that is a base of the soil. The existence of wet sand or soil in the subsurface rock is good for supporting the body of temple.

The vertical electrical sounding interpretation of point S1 and S2 are illustrated in Fig 3. S1 is located in east side of Siwa and S2 is located in west side of Nandi. Based on the model, thick of the surface soil is less than 2 m, and there is about 2 m thick of high resistivity layer (ohm-m) at Siwa floor. We interpret it as an andesitis rock or a foundation rock. However, in S2 the resistivity is not so high, and lower than this layer is low resistivity area, it may be a wet sandstone, wet soil, and gravel as a water level. According to Ijzerman in Jordaan, 1996 in a depth of 5.75 m under the floor, there was a container 41 cm long and wide and 53 cm deep. The top of lid, which is made of soft marlstone, is diamond-shape and coping of soft, light-yellow sandstone fits into the container. The foundation consists of three layers of stone, which together achieve a thickness of 1.15 m, on digging further, round river stones in sand were discovered and at 15.90 m, water.

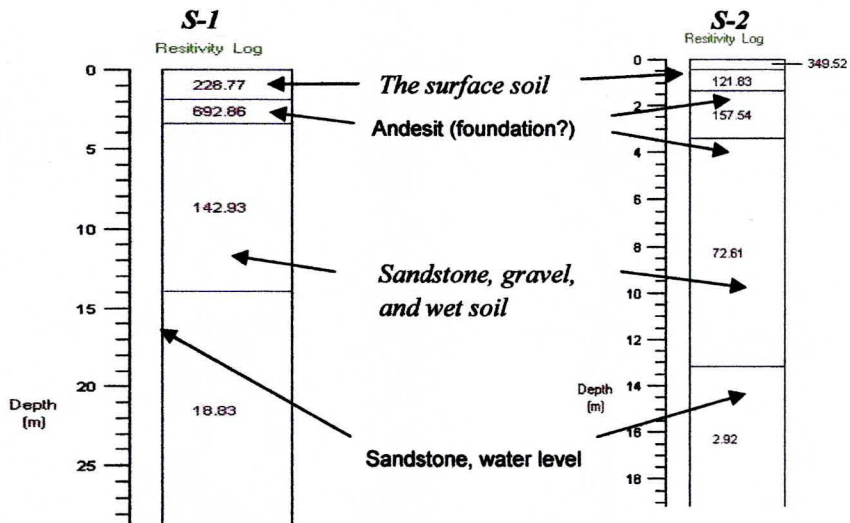
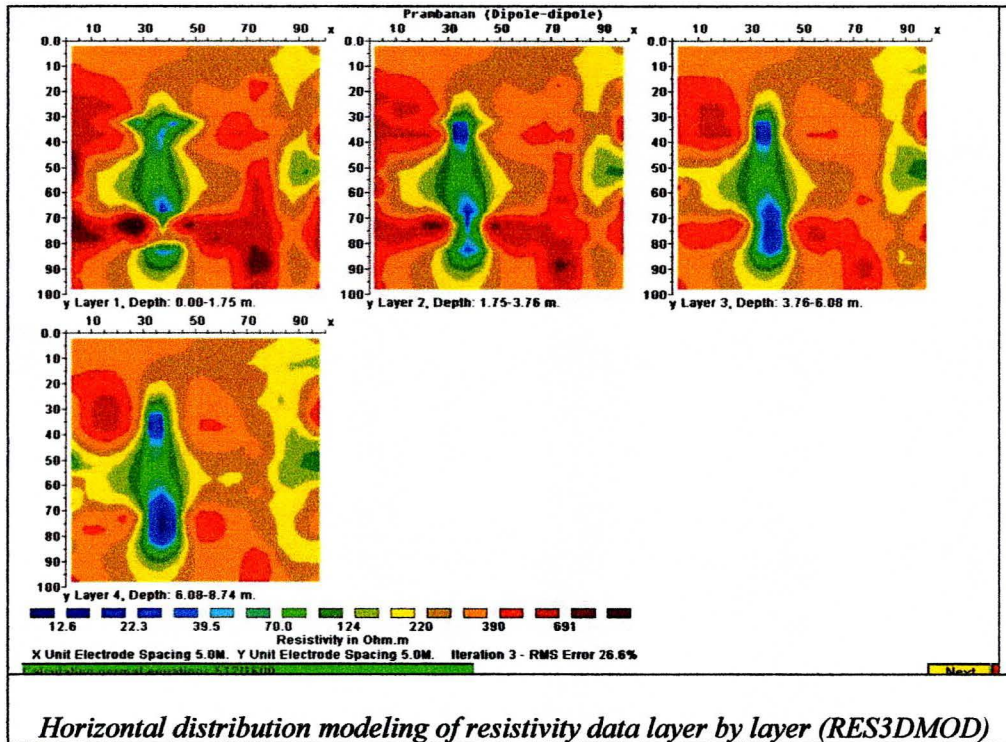

Vertical electrical sounding interpretation of points S1 and S2 by Progress 3.0.

5. Seismic Mapping Result

The seismic first break time measurement and processing data are plotted in fig.4a-e. The depths for each line are illustrated in those figures as well. The velocity for

first layer (in white color) is about (200-270) m/s which is interpreted as surface rock. The velocity of the second layer in brown color is (400-500) m/s that is indicated as a hard rock. Figure 4a (line US-1) indicates that there is a different depth. The depth in the north side is relatively shallow (5 m), whereas the depth in the south side is about 8 m. For line US-2 (fig. 4b), the depth of the hard rock is relatively flat in 8 m. The depth in line US-3 (fig.4c) is not so difference with line US-1, that is about 8 m in the south area and 5 m in the north side.

For east-west lines, TB-1 and TB-2 in fig.4d and fig.4e have a discrepancy structure. The depth in TB-1 at the middle of line is deeper (8 m) than at the both edge (4 m), while the depth in TB-2 in the both edge of line is deeper than in the middle of line. It means that the seal rocks of the surface have an average depth is about (5-6) m, and the body of the temple are supported by the hard rock in (5-6) m below the surface.

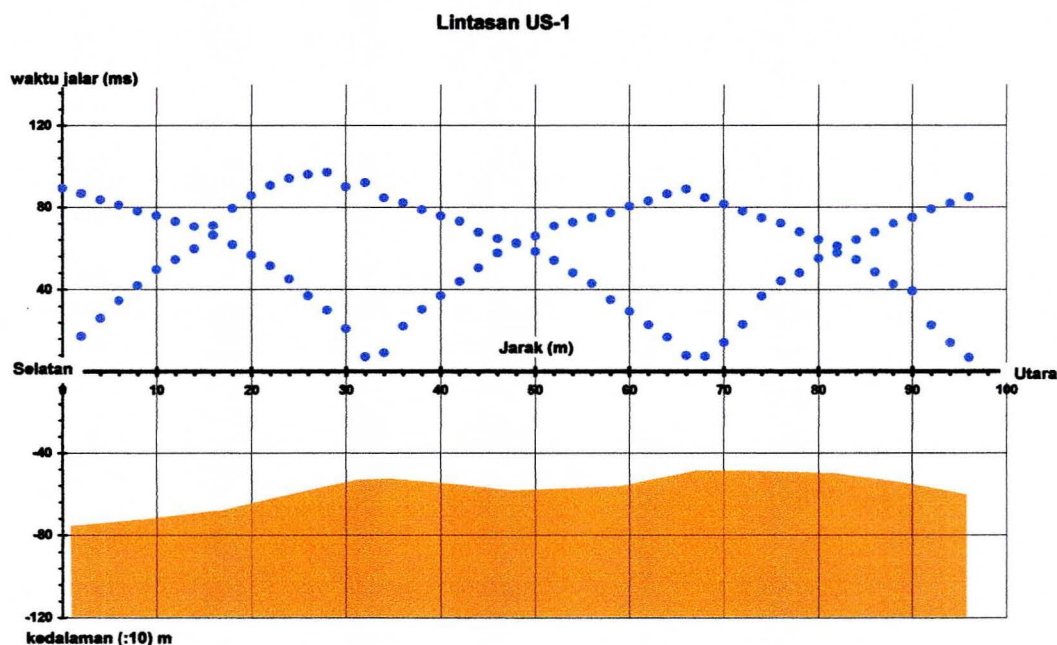

*Line US-1 seismic data and its depth interpretation in dm.
The first layer velocity is (200-270) m/s, and the hard rock velocity is (400-500) m/s.*

Lintasan US-2

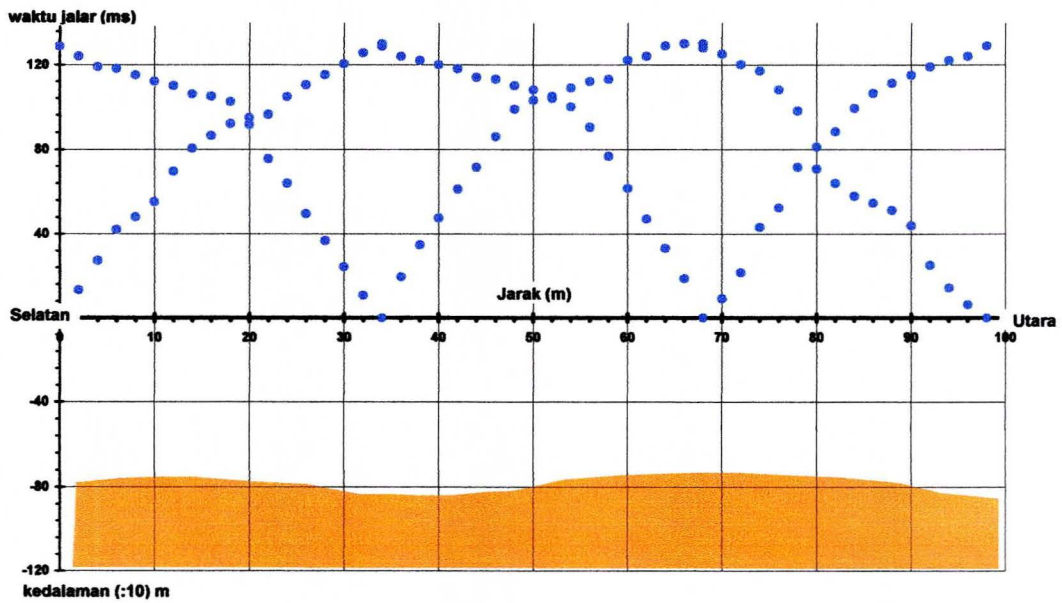

Line US-2 seismic data and its depth interpretation in dm.

Lintasan US-3

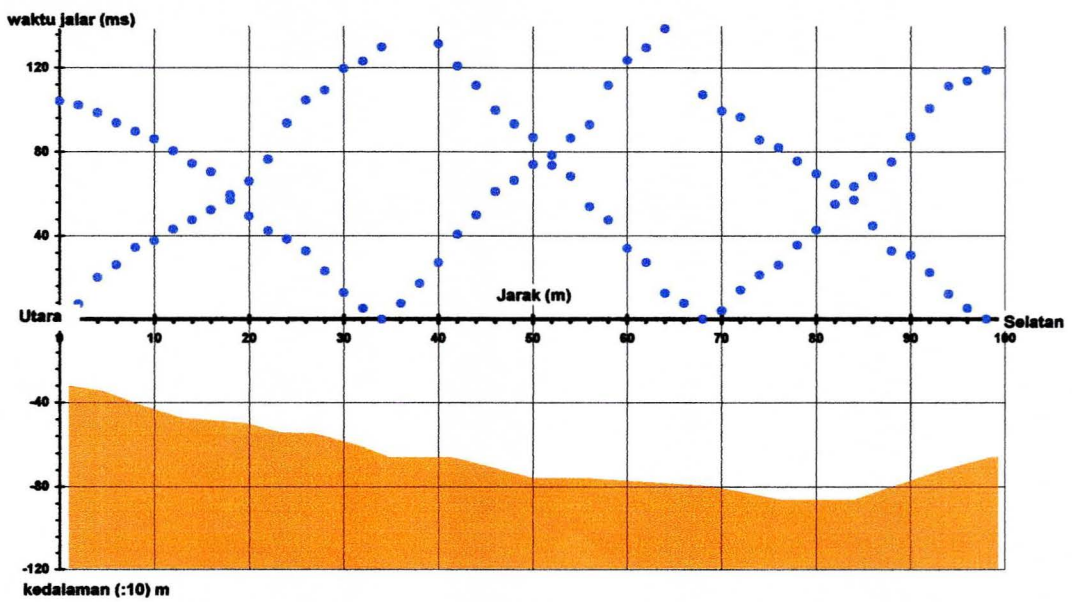

Line US-3 seismic data and its depth interpretation in dm.

Lintasan TB-1

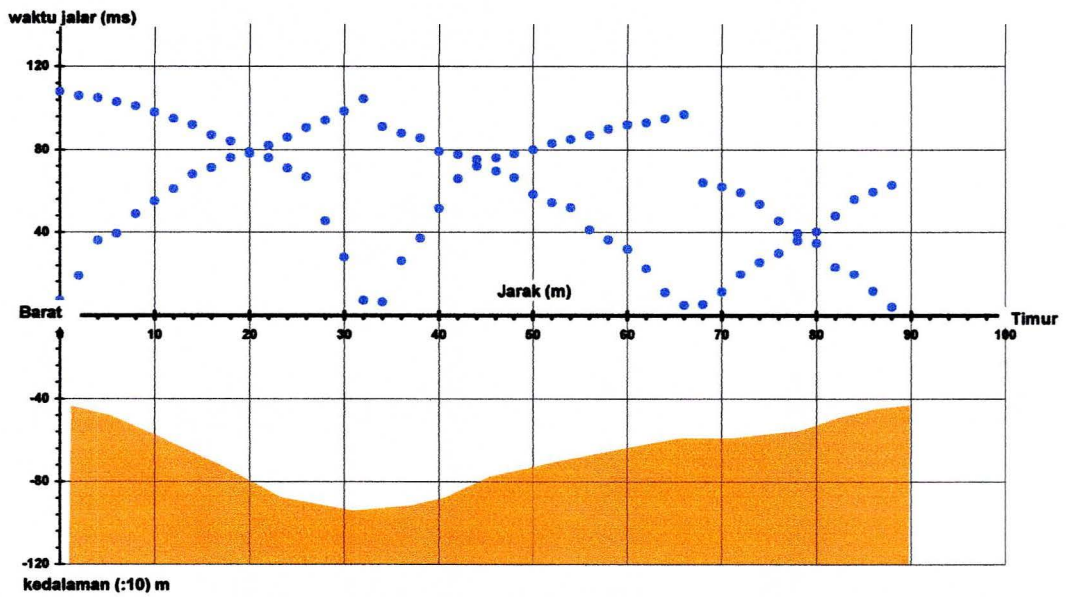

. Line TB-1 seismic data and its depth interpretation in dm.

Lintasan TB-2

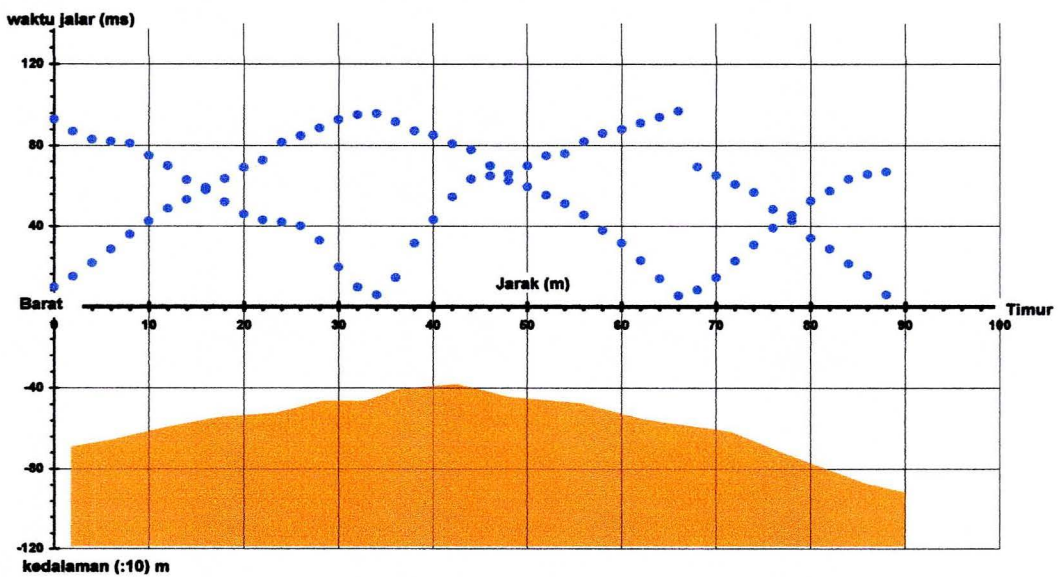

. Line TB-2 seismic data and its depth interpretation in dm.

6. Conclusion

The results show that the bodies of temples are supported by velocity of hard rock is (400-500) m/s and the resistivity is > 200 ohm-m, whereas the depth of the hard rock is (4-8) m from the surface. The thick of the seal soil is about 8 m in the south area and 4 m in the north area. The low resistivity in front of the Siwa, Wisnu and Brahma temple at east side, estimated as a drainage system of the Prambanan temple area. More than 13 m will find the sandstone with saturated of water.

E. Geo-electric, geotechnical, and geo-radar test

To recognize the condition of the soil under the temples in Prambanan temple compound we made several tests, e.g. geotechnical, geo-electric, and geo-radar ones. The geotechnical test was combined with geo-electric, while geo-radar test was used to recognize the depth of crack in the temple's body in horizontal direction, and the condition behind the outer wall of the temple.

The testing result :

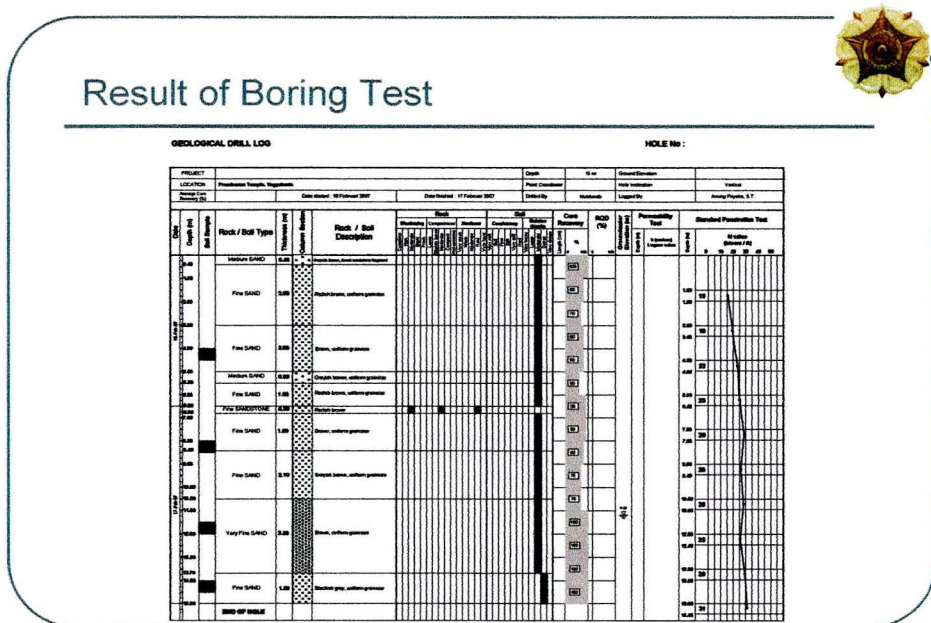

Result of Boring Test (Location: Front of Çiwa Temple)



- From Bor log

Depth:	Description
0,00 – 0,50 m	greyish sand with manmade modification (pudel);
0,50 – 3,00 m	fine sand: redish brown with uniform grainsize;
3,00 – 5,00 m	fine sand: brown with uniform grainsize;
5,00 – 5,50 m	medium sand, greyish brown with uniform grainsize;
5,50 – 6,50 m	fine sand: brown with uniform grainsize;
6,50 – 6,80 m	fine sandstone, redish brown;
6,80 – 8,40 m	fine sand: brown with uniform grainsize;
8,40 – 10,50 m	fine sand, greyish brown with uniform grainsize;
10,50 – 13,70 m	<u>very fine sand: brown with uniform grainsize;</u>
13,70 – 15,00 m	<u>fine sand: blackish grey with uniform grainsize.</u>

3/28/2007

Soil Mechanics Laboratory
CEED-GMU

3

SPT value of Boring Test



- From $\pm 0,00 - 15,00$ m SPT value increases gradually
- | | |
|---------------------|-----------------------------------|
| $N_{SPT} = 15 - 29$ | from $\pm 0,00 - 15,00$ of depth. |
| $> 15,00$ m | $N_{SPT} = 31$ |

Criteria from Peck et al. (1977):

N_{SPT}	Relative density
15 – 29	fair
≥ 30	dense
≥ 55	very dense (rock layer)

Internal friction angle of soil: $30 - 32^\circ$

Bearing capacity of soil $150 - 175$ kN/m²

Ground water level at depth 11,20 m

3/28/2007

Soil Mechanics Laboratory
CEED-GMU

4

Resume



- From bor log and value of N_{SPT} can be interpreted as following
 - Soil at test location is embankment soil, with relative density fair & uniform from depth of $\pm 0,00 - 15,00$ m.
 - Original ground elevation is located at depth of $14,00 - 15,00$ m.
 - Occur change of soil composition at depth $15,00$ m, and also value of N_{SPT} .
 - Ground water level is observed at depth of $11,20$ m.

3/28/2007

Soil Mechanics Laboratory
CEED-GMU

5

Geolistrik detail lokasi candi (denah)

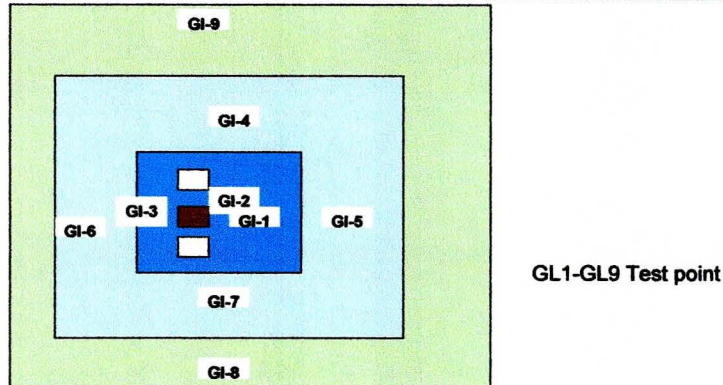

GL1-GL9 Test point

Keterangan :

- | | |
|-----------------------|----------------------------|
| : Siwa Temple Complex | : Perwara Temple Complex |
| : Siwa Temple | : Prambanan Temple Complex |

3/29/2007

Soil Mechanics Laboratory
CEED-GMU

6

Result of detail geo-electrical test (Çiwa temple)

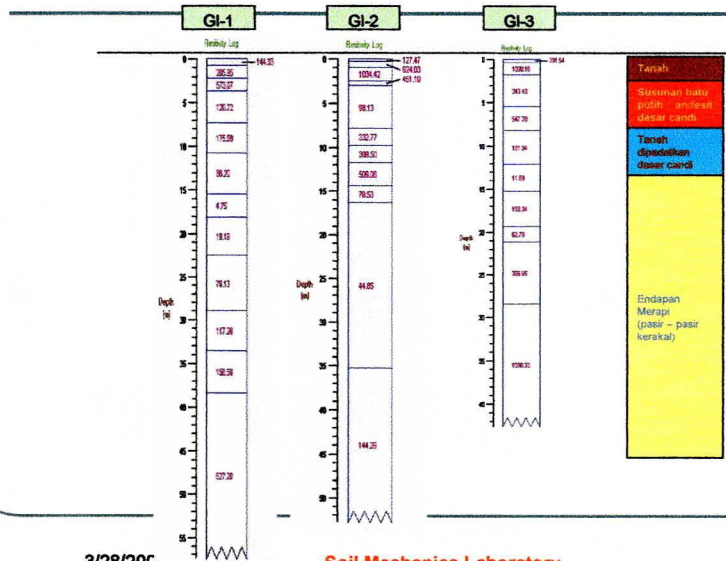

3/28/2007

Soil Mechanics Laboratory
CEED-GMU

8

Interpretasi Hasil Uji Geolistrik Detail



● Potongan barat – timur (GL-6; GL-3; GL-2; GL-1; GL-5)

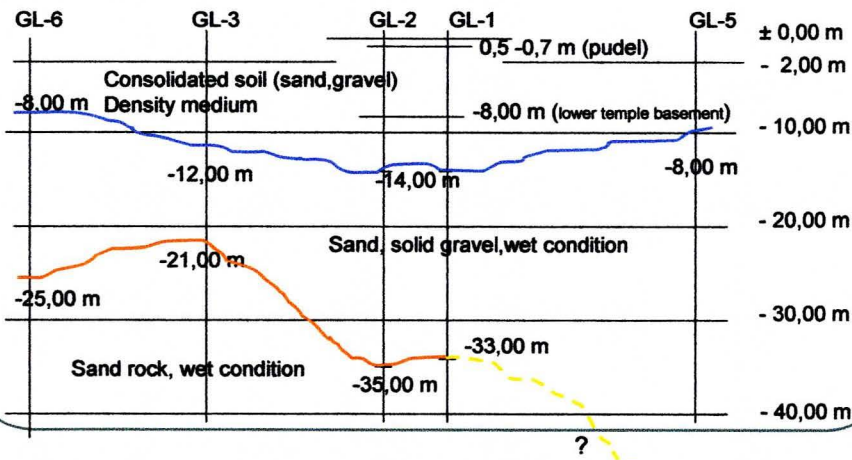

3/29/2007

Soil Mechanics Laboratory
CEED-GMU

9

Potongan utara – selatan (GL-9; GL-4; GL-2; GL-1; GL-7; GL-8)

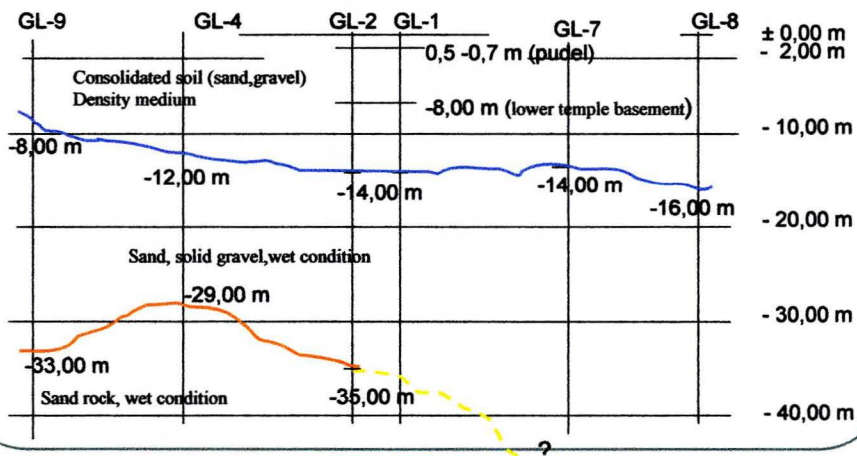

3/29/2007

Soil Mechanics Laboratory
CEED-GMU

10

Resume



- Original ground surface of temple area is basin.
- At Çiwa temple, original ground surface is located at 14,00 m of depth.
- Foundation of Çiwa temple is composed limestone (batu putih) and located at depth 8,00 m.
- Under limestone (batu putih) is followed compacted sand layer.
- Ground water level is observed at depth of 12,00 – 15,00 m.

3/28/2007

Soil Mechanics Laboratory
CEED-GMU

11



Result of Geo-radar Test at Temple Body

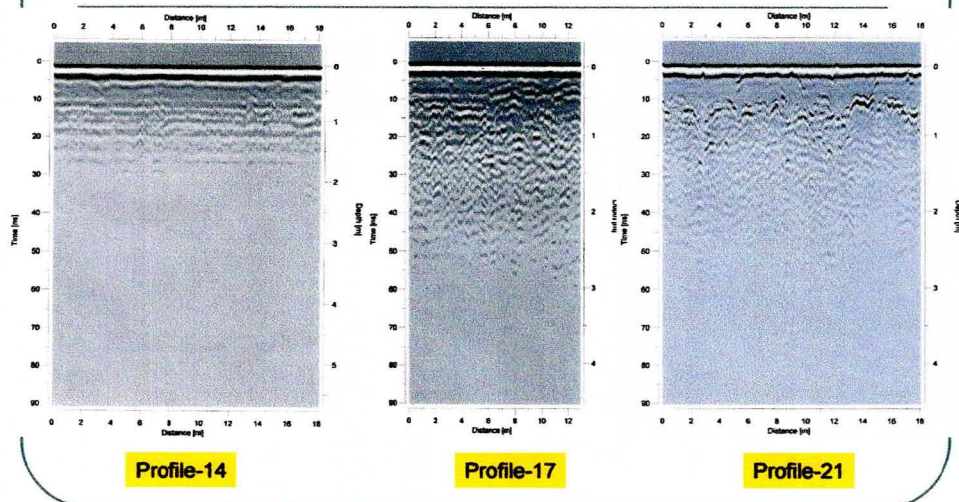

3/28/2007

Soil Mechanics Laboratory
CEED-GMU

13



Interpretation of Geo-radar Results

- The Siwa temple's yard consists of three layers; the top layer consists of soil/sand to level the yard; the middle layer consists of consolidated soil and the lowest layer consists of the original soil which has a high carrying capacity.
- Siwa temple was built using two type of stones, andesite in the outer structure (50 cm) and limestone in the inner structure.
- The past restoration of Siwa temple included reinforcement concrete in the main structure but not in the each temple corners.
- The cracking on Siwa temple occurs in all part of the structure especially in the part which face directly to the gate (west side, north side, east side and south side). The cracks measures 1,50 – 2,50 m (on the gallery wall and basement I).

The conclusions of those tests are a.o.:

1. Prambanan temple compound is located in a hollow and in the east of Siwa temple there is a spring
2. The original soil is 14 m under the present soil
3. The soil was improved by adding compact sand 6 m deep
4. The foundation of Siwa temple that consists of tuff is still intact
5. The main structure of Siwa temple is still strong, since it has reinforced concrete construction that formed a portal structure
6. The crack on the wall of Siwa temple reaching 1,5 – 2 m deep. It was caused by the burden from the stone blocks above the lintels, as a consequence of the earthquake

F. Geology of Prambanan Area

The 5,9 Richter earthquake on 27 May 2006 which struck Daerah Istimewa Yogyakarta and some parts of Central Java caused heavy damages on Prambanan temple complex. From geology point of view Prambanan temple complex is located on the active fault which extends from Prambanan, Piyungan, Pleret, Imogiri and Pundong. This fault is called Opak fault. This fault becomes active as a result of earthquake' activity. The Prambanan temple complex is located in an area which is associated with natural disaster especially earthquake. There are three faults in Prambanan area, Ungaran fault (northwest – southeast), Opak fault (southwest – northeast) and Jiwo fault (west – east).

Observation result Prambanan temple after earthquake state that there are cracks which direct to the north – south. One crack was found in the first yard in the west of Brahma temple. It measures ± 30 meter while the wide is $\leq 2 - 3$ cm. The second crack was found in the second yard in the northeast of Perwara temple line I. The crack split between two Perwara temples along 9 meter and the wide is 2 cm.

1. Geology of the Prambanan Temple Site

The Prambanan Temple of Yogyakarta is located at the southern slope of Merapi Volcano, and adjacent to the Prambanan High at its south (Figure 1). Geologically,

Yogyakarta lies on a Quaternary basin that is filled by the Merapi sediments and bordered by two mountainous area; the Kulonprogo Mountain in the western part and the Southern Mountain in the eastern part. The temple is bordered by two main rivers, named as the Opak River at the west and the Borongan River at the east. Analysis on the available satellite images indicates an ancient anthropogenic influence on the river drainage pattern around the Prambanan Temple site (Figure 2)

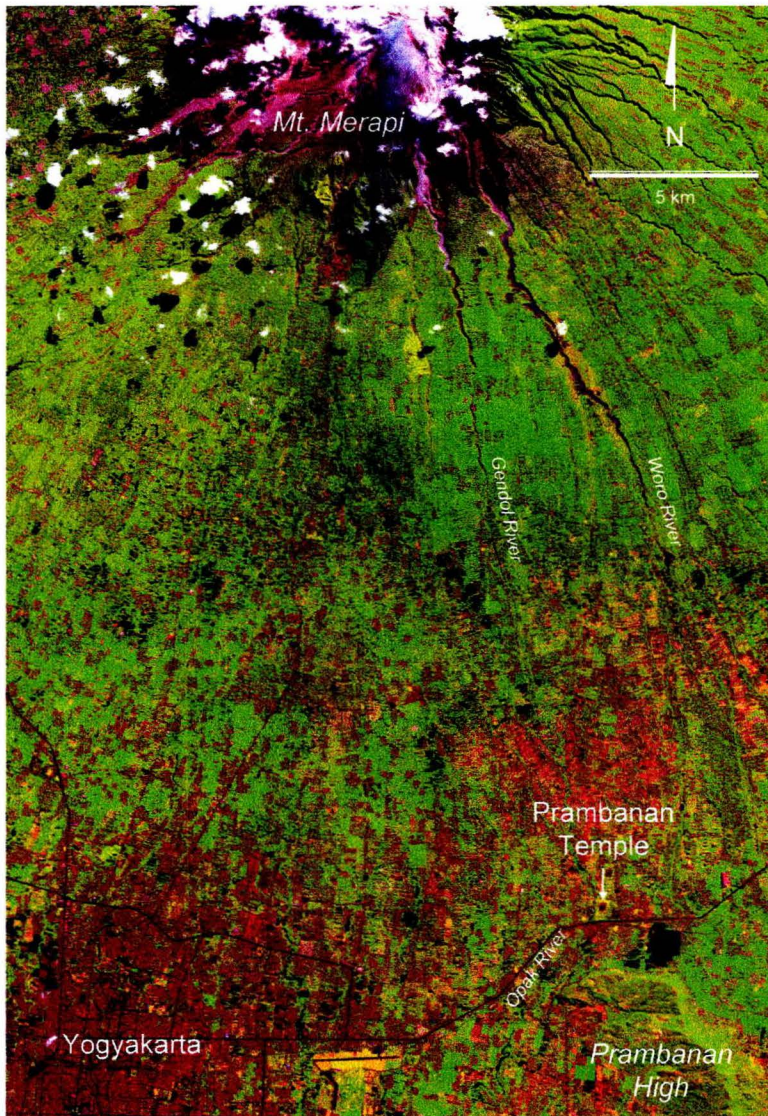

Figure 1. Satellite image of the Prambanan Temple site and its surrounding area (SPOT, 2005). Recent volcanic deposits around the summit of Mount Merapi are indicated by grey color. Some of the deposit are transported downslope southward and westward by fluvial processes and occupy the river valley upstream. Gendol River that flows southward is replaced by Opak River downstream and pass nearby the Prambanan Temple before deflected westward by the Prambanan High. Paddy fields are indicated by green color, whereas town and populated places are indicated by pink color.

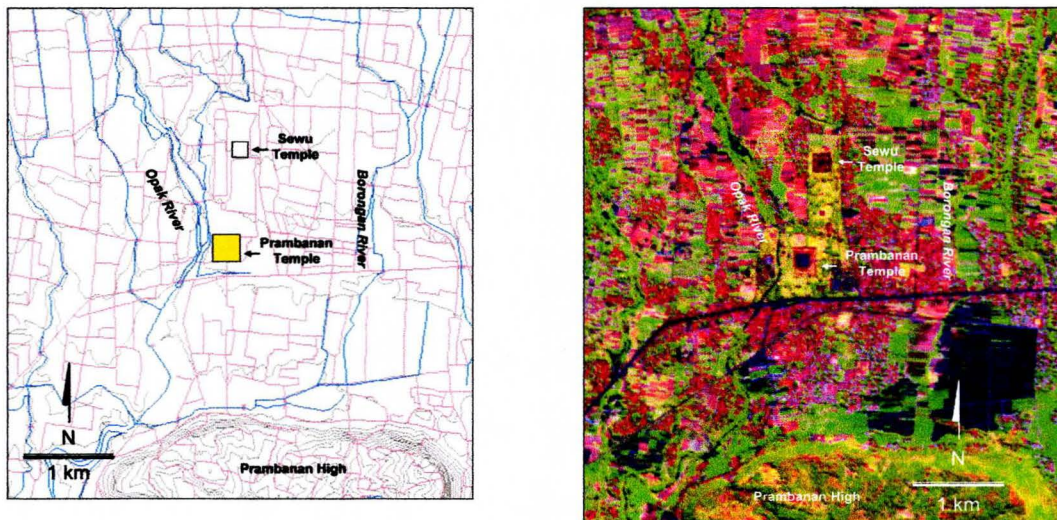

Figure 2. A large scale satellite image (left) of the Prambanan Temple site and its topographic map (right). Few small tributary channels occurs in the north of the Sewu-Prambanan complex and joined with the main Opak River right next to the Prambanan Temple. The drainage pattern of those rivers suggest an ancient anthropogenic influence that controlled their flow around the temple complex.

There is no existing geological observation reported from the temple site. Its geological condition is deduced from the field observation at Kedulan and Sambisari temples which are located about 3 km and 5 km westward, approximately lie at the same elevation as Prambanan Temple, and across the Opak River. Those two temples are buried below 15 m sediment that composed of an interbedded series of lahar and fluvial deposits (Newhall et al., 2000). The ash and tuff deposits from Merapi eruption that lie on the temple floor indicates an approximate age of 700 year before present. Hendrayana (1993) interpreted from several boreholes on the western side of the Opak River that the thickness of the intrebedded series of lahar and fluvial deposits may reach to 70 m depth below ground surface. They overlie a much older Merapi laharic sediments, to the depth of 90 m, which is unconformably deposited over the Tertiary limestone of Sentolo Formation.

It is interesting to note that those three temples which approximately lied at the same distance from Mount Merapi are found differently in respect with ground surface. The Prambanan Temple that located at the eastern side of the Opak River is lied above the ground, whilst the Kedulan and Sambisari temples which located at the western side of the Opak River are lied below the ground. This implies two supposition, first is that the

Prambanan Temple was already anthropogeneously risen above the ground since its first construction processes, second is that the Prambanan Temple was naturally lied above a paleo high ground of the eastern side of the Opak River and the following Merapi eruption only fill the lower ground of the western side of the Opak River. It is difficult to confirm the first supposition as it requires a detailed sub-surface geological study over the area. The second supposition indicates a paleo-morphology that was remarkably different as it can be seen today. It is likely to occur that the Prambanan Temple as the greatest temple in its time was built over a paleo high ground, such as a hilly morphology, much alike the world-famous Borobudur Temple which is located 30 km northwest from the Prambanan Temple.

The Prambanan Temple, is interpreted to be lying on the northeastern tip of the Opak Fault, trending northeast-southwest along the Opak River down to its rivermouth (Figure 3; Rahardjo et al., 1995). The Opak Fault is known as the western boundary fault for the Yogyakarta Basin, which borders the basin from the adjacent Southern Mountains of Gunung Kidul. The temple is also lying on the eastern tip of another fault system that extends east-west and crossing the Yogyakarta town (Figure 3; MacDonald, 1984).

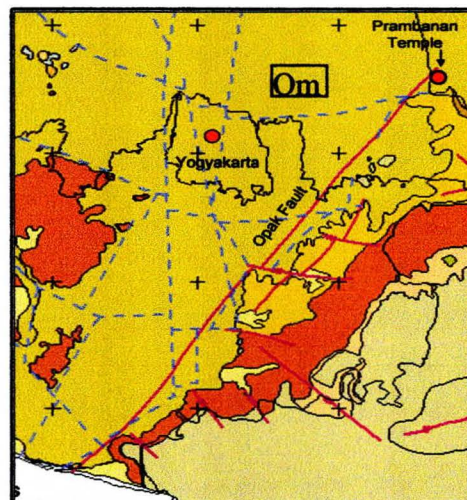

Figure 3. Geological map of Yogyakarta area (modified after Rahardjo et al., 1995 and MacDonald, 1984). *Qmi* (pale green color) is young Merapi deposit that covers almost Yogyakarta basin, including the Prambanan Temple site. It is surrounded by the exposed much older Tertiary rock formations (other colors) at the adjacent hills. Opak Fault is indicated by heavy pink line, trending northeast-southwest. The east-west fault system is found at the basement rocks covered by the young Merapi deposit and indicated by dashed blue lines.

2. Seismicity of the Prambanan Temple Site

The Prambanan Temple was severely damaged by the May 2006 Earthquake. The epicentrum of the 5.9 earthquake was located at the Opak downriver, about 20 km southward of the temple. Most of the destruction on the temple occurs by the ground motion as indicated by the collapse of temple's crown, some blocks were rotated and few ground cracks on the temple's yard.

Previously, although Yogyakarta was hit by several large earthquake, such as at 1943 with an epicentrum at 75 km offshore south of the shoreline and at 1867 with an unknown epicentrum, there was no damaged reported to the Prambanan Temple. Therefore it is assumed that the earthquake susceptibility of the Prambanan Temple depends on the location of the earthquake epicentrum. If the earthquake occurs near to the temple and along the Opak Fault, such as the May 2006 event, a severe damaged to the temple is likely to occur. Furthermore, the presence of ancient fluvial deposits beneath the temple as speculated from the satellite images analysis, may endanger the construction above when a large earthquake occurred as the such soil could strongly amplify the earthquake ground motion. This clue is given by an on going research of the earthquake microzonation at Bantul area, southwest of the Prambanan Temple, which is conducted by the Geological Engineering Department of the Gadjah Mada University.

IV. DAMAGE ANALYSIS

A. Analysis on Temple Structure

Temple's structure, its loads and its behavior to the loads are important consideration to decide the recovery project. The data and the information are useful to chose and decide the suitable methods to reconstructs the damages on the temples after the earthquake.

1. The Structure

In the past restoration, the Tri Murti temples had included the structure reinforcement by installing reinforced concrete and pairs of stones. The spaces between outer stones and the reinforced concrete are filled with concrete. The reinforcement has made the temple become monolith. The structure of the temple stands on the stone arrangement as a temple's floor. Its floor is supported by a basement. Each temple in Prambanan temple complex has a different type of structure reinforcement. The reinforcement in Brahma temple is set starting from its upper basement. On the Brahma temple's floor is reinforced with circular sides frame and concrete plate. While in Wisnu temple, the reinforcement is inserted on the upper section of the temple floor. The concrete reinforcement structure is not set on the temple floor. Wahana temples also have the similar treatment with the Wisnu temple.

The reinforcement system influences the structure behavior when there is an earthquake. Structurally, the Tri Murti temples structures consist of basement, body and accessories. The basement is a temple floor which supports the temple body. The temple body is a structure which stands on the temple floor. The accessories are the sections which are put on the body and the temple floor. The examples of the accessories are Ratna, the gate, the balustrade etc. The quality of the bonding on the accessories is not the same with the stone bonding on the temple body. This fact makes the accessories sections will move in different way with the body when the earthquake occurs. The different types and forms of the bonding on each structure influence on the structures movement when the earthquake strokes and causes the different type of the damages. On the other part of this paper the damages on the accessories are defined as material damages. On the discussion of the temple structure, damages analysis is based on the type

of the damages on the temple parts such as on the basement, body and accessories. This consideration is made dealing with the similarity of the structural behavior on each parts.

2. Loading Case

The temple structure support 2 (two) loads which can be classified as a gravity load and earthquake load. The gravitation load is a load which occur because of the gravity force. This load is also defined as a static load. While the earthquake load is defined as a dynamic load which only occur when the earthquake stroke the building. The dynamic load also occurs when there is an explosion. Because it rarely occur, sometimes this type is not considered or discussed.

a) The gravity load

This called is defined as a static load. The gravity load which exists in the structure is a self weight and load occurs because of the existence of other things such as people, scaffolding etc. In the temple structure the second type of the load is not really dominant. The temple structure which consists of stone block arrangements will produce a massif and a heavy weights. The heavy weight of the temple building make this load will form a static load to the structure of the temple.

b) The earthquake load

Other load that occurs in the temple building is temporary load such as earthquake and wind load. The most dominant load in the temple structure is the earthquake load. The earthquake occur a sudden violent movement of the earth's surface and it is also followed by releasing of energy. The energy emerges from the epicenter and spreads to some direction in the form of waves. The wave which derives from the earthquake can be classified into some type based on its directions and its movements

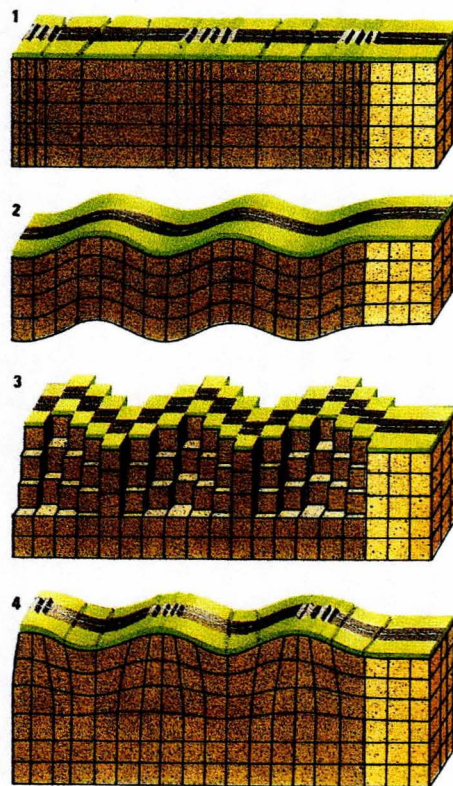
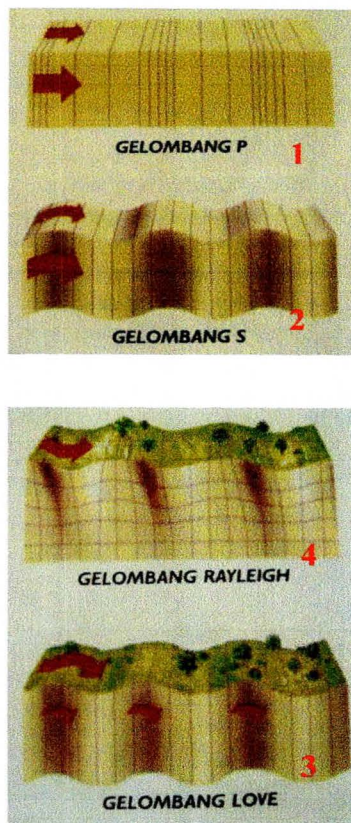

The earthquake wave

P Wave (no1) is a compression wave

S wave (no2) can be classified into two, they are shifting wave SV (no 3) which occur on one section vertically with P wave and SH wave (no 4) which occur vertically with P wave and SV. The impact of the two waves (P wave and SV wave) is a torsion movement. The waves of the earthquake 27 May in Yogyakarta and Central Java come from the southwest to northeast.

The wave which spread in the lithosphere causes the movement of the earth's surface. The movement makes the things such as buildings shake. When the earthquake occurs, the building structure moves to some directions depend on some factors such as the form of the structure, the weight of the structure, the location of the structure, the type of the material, structure measurement etc. The energy which causes the movement of the building is called the earthquake load.

Generally, the earthquake load is a result from soil movement acceleration by seismic wave which spreads in the lithosphere. The movement of the building is depend on the types of the earthquake wave such as vertically, shaking, shifting, torsion etc. The movement of the structure influences the stability of the internal force in the building. The change of the force causes the structure deformation in the building (temple). If the deformation occurs still in the material or structural capacity, it will not cause the bad impact or the structure damage. But if the excessive deformation takes place over the material and structural capacity, this phenomenon will cause the structural damages on the temple building. The intensity of deformation is based on some aspects such as the type of material, the size of material, the form of material, the weight of the material and the type of the connector between stones.

3. Structure Deformation

The load on the specific material or structure causes internal force which includes compression force, shear force, moment force and torsion force. The impact on the material or structure is against reaction which forms a deformation. The deformation will accommodate the stress on the material or the building. The deformation and the stress on the material and the structure depend on the forces which occur on the material and the structure. The deformation which is caused by the forces can be classified into two, Longitudinal deformation (in the same direction with the axis) and lateral (vertically to the axis). The longitudinal impacts are extending or shortening of the axial force, flexible deformation of the moment and shifting deformation on the shifting force. Lateral deformation can be observed through the change of the material form because of the compression force (Davis et al, 1955). In the load mechanical study, the research is conducted on the material behavior when it is compressed. The comparison between the longitudinal and lateral deformation will produce poison data by number which can show the comparison of the material shrink to the extended value of the material which is caused by the stress force on the material or structure.

The excessive deformation on material or structure causes the collapsed of the structure. The type and the speed of the loading case influence the material fracture method. The gravity force always exists and it is a sustained load. The deformation as a

result from this force takes a long time so that will cause a creep or tension spreading. The collapse of the structure will be preceded by the occurrence of the micro cracks on the material or structure (Bould, et al.,1982; Heighdon, 1978).

A detail observation on the stone condition in field shows that the micro cracks does not occur on the stones. So it is assumed that the condition on the temple body still stable.

The earthquake load is a load, which takes very short time. The speed of this load is very fast depends on the soil movement acceleration and the stiffness of the structure. The load is a dynamic load which the has a multiple power (Clough et al, 1982). The material or structure will collapse on the higher level of the load compare with the building capacity. The suddenly collapse will be preceded by some cracks or breaks on the structure. The field survey states that breaking stones occur on some temple buildings' parts especially on the basements and the floor. The facts indicate that the sudden strong load has happened when the earthquake occurs. Its power is stronger than the material (stone) capacity. Considering that the past restoration had made the temple structure became monolith using cement or mortar, the breaking stone can indicate that the power of the bonding agent is more dominant compare with the stone itself. To avoid this damage, the bonding agent should be weaker than the stone or the bonding agent should made from an elastic material so that can facilitate the movement of the stones when there is a dynamic load or earthquake occur.

The earthquake load also produce a torsion effect on the temple structure. It can be observed obviously on the circular cracks on Siwa temple. The cracks occur on the basement. The cracks also followed by the shifting of the upper and lower part of the cracks. The cracks mostly occur on the connection between stones. Some of the cracks cause the break of the stones. The breaking stones can be found on the temple corners. Mechanically, the corners are the part, which resists torsion force. The stone breaking on the corner part are caused by 1) The bonding agent on the spaces between stones is stronger than the stones itself or 2) There is a restraint of the stone arrangement so that the structure can not twist on one shifting section. The torsion effects can be observed on some parts of the temple such as on the gates and ratna.

B. Material Damage

There are two terms to define the change on the material, there are damaged and putrefied. The damage is the change of the material form where the physic and chemical characteristics do not change. The putrefied is the change of the material into other material where the physic and the chemical also change. In this report we use the first term for the next discussion.

The power of the culture heritage building's material will decrease. The causes can be classified into two factors. They are external factors such as static force, dynamic force and physical force and internal factors such as the type of the material and building structure.

The earthquake is a dynamic force in the form of compression force which can cause the stone cracks and breaks. The crack on the stone is also caused by the static force (stone load). The static force derives from the stone arrangement in the upper part of the stone.

The reinforcement in the Tri Murti temples can be classified into three parts, they are:

- a. There is not reinforcement in the spaces between stones
- b. The space between stone is reinforced using cement which make the temple structure become monolith or the spaces between stones are connected between dowel (latter U dowel).
- c. The spaces between stones are not connected using dowel.

The material in Prambanan temple complex is gray andhesite stone. The dominant mineral which forms the stone is Plagioclase (39 % - 46 %). The physical characteristic especially the stone which has a low porosity, cracks 138 -183 kg/cm² while breaks 231 – 290 kg/cm². Stone which has medium porosity crack 61-142 kg/cm² and break 79 – 196 kg/cm².

Material damages include the cracking of the stone, breaking on the stone and total breaking. The broken and cracked stones are caused by the P Wave of the earthquake. The damaged stones can be found in the stones which are connected using the bonding agent. This stones are damaged because they can not move freely when the

earthquake occurs. The stones damaged also because of the collapsed stone hit other stones.

Some stones which loose from its position are caused by imperfect dowel installation, the adhesive power of the bonding agent is stronger then the stone and the effect of the (S) wave of the earthquake. This type of the damage is mostly occurs in ratna.

It is explain that the bonding agent is stronger than the stone while the depth of the dowel is only 5 cm with its diameter 12 -15 mm. The fact makes the ratna collapse but its dowel does not broken. Without dismantling, it can be assumed that the material damages only take place on the outer stone because the inner stones are reinforced with the concrete construction which is set behind it. It is also assumed that the water repellent which can avoid the calcium melting also in good condition.

V. RECOMMENDATION

Considering the result of the observations and the tests having been done up to this time, we propose :

1. The other temples, except Siwa temple, can be restored preceded by partial dismantling. For Wisnu temple, an additional reinforced concrete construction is needed to insert on its basement.
2. Considering the history of the restoration on Prambanan temple compound especially Siwa temple (vide. The history of the restoration) there are three options:
 - a. Whole dismantling beginning from the topmost part. If we choose this option, the difficulty will be on the dismantling of the topmost components mentioned before, because they were stucked together by using cement and iron wall-ties. Therefore, we will need crane to do that task.
 - b. Partial dismantling which will be done per quadrant. It means that the dismantling will be done from base of the body up to the base of the roof. During the restoration process modern technology can be combined with the simple one. On the other hand, this restoration work can be promoted as an alternative cultural tourism object.
 - c. There needs no restoration, except using the grouting method to strengthen the temple. But, it must be preceded by researches in choosing materials that will be used, to prevent a toxic consequences to the ecology.
3. Need further studies for Siwa temple with aim to find out the detail damage inside the structure of the temple.
4. Need environmental studies to find out the real line of the early river in place of the Prambanan complex before moving in to the complex. The information of the line of the early river is based on Siwagraha inscription

Rehabilitation plan of Brahma and Wisnu temple

a. Preparation Work

No	Item	Volume	Unit	No	Item	Volume	Unit
1	Scaffolding			3	Infrastructure		
a	Pipe A Ø 3 “	1.100	bar	a	Stone storage		
b	Connector 3 “ (2 pipe)	2.000	bar		Open	2.000	m ²
c	Beam 8/12 -400	100	bar		Close	300	m ²
d	Board 3/25 - 400	100	piece	b	Trasportation route	100	m
e	Stirrup	200	unit	c	Site office	500	m ²
f	Nails 2 “	200	kg	d	Material storage	100	m ²
2	Work Equipment						
	Lift	2	unit				

a. Rehabilitation of Brahma temple

No	Project	Volume	Unit
1	Scaffolding instalation	1	Packet
2	Documentation	1	Packet
3	Dismantling	241,57	m ³
4	Fragment collecting	157	Unit
5	Stone cleaning (the dismantled stone)	1752	m ²
6	Fragment matching	201	Unit
7	Fragment joining	82	m ²
8	Anastilosis	9,64	m ³
9	Replacement stone	43,15	m ³
10	Detail carving	52	m ²
11	Trial reconstruction	300	m ³
12	Reinforcement with dowel	316	m ³
13	Reinforcement with reinforced concrete	42	m ³
14	Reconstruction	300	m ³
15	Building cleaning	4240	m ²
16	Reposition on space between stone on roof part	19200	m
17	Water repellent smearing on roof part	3200	m ²
18	Consolidation on week stone	12	block
19	Injection on crack	108	block
20	Ligting conductor installation	120	M
21	Other	1	packet

b. Rehabilitation of Wisnu temple

No	Project	Volume	Unit
1	Scaffolding instalation	1	Packet
2	Documentation	1	Packet
3	Dismantling	156,34	m ³
4	Fragment collecting	96	Unit
5	Stone cleaning (the dismantled stone)	1087	m ²
6	Fragment matching	29	Unit
7	Fragment joining	39	m ²
8	Anastilosis	5,2	m ³
9	Replacement stone	5,4	m ³
10	Detail carving	21,6	m ²
11	Trial reconstruction	189,6	m ³
12	Reinforcement with dowel	134	m ³
13	Reinforcement with reinforced concrete	20	m ³
14	Reconstruction	189,6	m ³
15	Building cleaning	4240	m ²
16	Reposition on space between stone on roof part	19.200	m
17	Water repellent smearing on roof part	3.200	m ²
18	Consolidation on week stone	11	block
19	Injection on crack	92	block
20	Ligting conductor installation	120	M
21	Other	1	packet

REFERENCES

- Anonim, 1980, Peta zona seismik untuk perencanaan bangunan air tahan gempa, Direktorat Jenderal Pengairan, Jakarta, Indonesia.
- Begemann, H.K.S., dan Hoogkamer, E., 1974, Stability calculations the restoration of Borobudur, Re-port CC/III/2/1974, Depdikbud RI, Jakarta.
- Bould, N.R., 1982, Mechanics of Materials, Books / Cole Engineering Devision, Monterey, California.
- Clough R.W. and Pensien, J., 1982, Dynamics of structures, McGraw-Hill International Book Company
- Das, B.M., 1995, Principles of Geotechnical Eng., PWS Publ., Boston, USA.
- Davis, H.E., Troxell, G.E., and Wiskocil, C.T., 1955, The Testing and Inspection of Engineering Materials, Second Edition, Mcgraw- Hill Book Company, Inc., New York.
- Heighdon, A, 1978, Mechanics of Materials, John Willey & Sons, Inc., London
- Holtz, R.D., dan Kovac, W.D., 1981, An introduction to Geotechnical Engineering, Prentice-Hall Inc., New Yersey, USA.
- Jordaan, R.E., 1996, In Praise of Prambanan. KITLV Press, Leiden, p.119-134.
- Lancellotta, R., 1995, Geotechnical Engineering, A.A. Balkema, Rotterdam, The Netherlands.
- MacDonald & Partners (1984). Greater Yogyakarta Groundwater Resources Study - Vol 2 Hydrology. Report of Groundwater Development Project (P2AT), Directorate General of water Resources Development, Ministry of Public Works, Government of the Republic of Indonesia, Sir M MacDonald & Partners in association with Binnie & Partners, Hunting Technical Services Ltd.
- Newhall, C.G., Bronto, S., Alloway, B., Banks, N.G., Bahar, I., del Marmol, M.A., Hadisantono, R.D., Holcomb, R.T., McGeehin, J., Miksic, J.N., Rubin, M., Sayudi, S.D., Sukhyar, R., Andreastuti, S., Tilling, R.I., Torley, R., Trimble, D. and Wirakusumah, A.D. (2000). 10,000 Years of Explosive Eruptions of Merapi Volcano, Central Java: Archaeological and Modern Implications. Journal of Volcanology and Geothermal Research, 100, pp. 9-50.
- Rahardjo W., Sukandarrumidi and Rosidi, H.M.D. (1995). Geological Map of the Yogyakarta Sheet, Jawa. Geological Research and Development Centre, Bandung.

Sukandarrumidi, 1999, Natural cementation of temple's building stone case study : The Borobudur Temple, Journal Media Teknik, Fakultas Teknik, Universitas Gadjah Mada, Yogyakarta.

Van Romondt, V.R., Djåwå 1940.

Wangsadinata, W., dan Djayaputra, A., 1979, Analytical assessment of seismic risks for Candi Borobudur, Report CC/VIII/5/1979, Depdikbud, Jakarta.

**Action Plan for the Rehabilitation of Earthquake-affected
Prambanan World Heritage Site
Prepared during International Experts Meeting, 6 – 9 March 2007**

No,	Issues identified by the Participants of Expert Meeting	Research Needs / Activities Required	Stakeholders/ Partners	Time Frame
1. Management and Coordination:				
	<p>Lack of coordination between various departments for managing the World Heritage Property</p> <p>Absence of visitor management plan especially during transition phase from emergency relief to recovery</p> <p>Absence of long term risk management plan</p> <p>Absence of tourism management strategy</p>	<p>Focus on four Areas of Management:-</p> <ol style="list-style-type: none"> 1. Site Management (including visitor management) 2. Conservation Management 3. Risk Management 4. Tourism Strategy <p>Creation of Steering Committee</p> <p>Representatives from: Government Dept. of Culture and Tourism, Ministry of People's Welfare, Indo NATCOM, BP3 of Yogyakarta and Central Java, PT Taman, Local Govt. of Jogjakarta and Central Java (Provincial and Regional representatives), national meteorology and geophysics</p> <p>Technical Committee:- Archaeological Office of Yogyakarta and Central Java, Experts from UGM, UNESCO, National level experts, International experts.</p> <p>Evaluation meeting of the technical committee to review the current status:-</p> <ol style="list-style-type: none"> 1. the management of the cultural heritage sites after the earthquake 2. technical aspects (conservation and restoration research and interventions). 3. the visitor management <p>Project Implementation Office</p> <p>Management of Financial and Other Resources</p> <p>Department of Archaeology as single window for managing financial resources from the following three sources of funding:-</p> <ol style="list-style-type: none"> 1. International 2. National (from the dept. and local government) 3. Local (provincial) 	<p>Secretariat: Directorate General of History and Archaeology</p> <p>Secretariat: Archaeological Office of Yogyakarta and Central Java</p> <p>Same as above</p> <p>Same as above</p> <p>Directorate General of History and Archaeology</p>	<p>3 months</p> <p>3 months</p> <p>Technical meeting to be organized within 3 months (short term) June / July</p> <p>3 months</p>

		<p>Site Management</p> <p>Site Management Activities during Recovery Phase:-</p> <p>Zoning (physical planning) for regulating visitors' movement</p> <p>Planning for restoration process (logistical details, storage of fragments, transportation, equipments, security)</p> <p>Discussion on common strategy for the Management of World Heritage Property (Prambanan and Sewu Temple)</p> <p>Conservation Management:</p> <p>Formulation of (site specific) technical guidelines for carrying out conservation and restoration</p> <p>Carrying out physical interventions</p> <p>Monitoring, Review, Evaluation and Reporting of Restoration and Conservation works</p> <p>Risk Management:-</p> <p>Integrated assessment of risks to the site from various natural and man-made disasters</p> <p><u>Risk Mitigation</u></p> <ul style="list-style-type: none"> - Research on site level and building level - Preparation of general technical Guidelines for similar cultural resources in the country <p><u>- Emergency Preparedness</u></p> <ul style="list-style-type: none"> - Procurement and location plan for emergency equipments (logistics) - design of emergency signage. - Evacuation Route - Formulation of emergency team of local staff - Coordination with other relevant 	<p>BP3 PT Taman</p> <p>BP3 PT Taman</p> <p>Task force Committee</p> <p>Directorate of Archaeology (leader), Reference ICOMOS guidelines and other relevant charters, BP3, UGM, Borobudur Conservation Institute, Department PU</p> <p>BP3</p> <p>BP3</p> <p>UGM, Regional Board of Meteorology and Geo-physics, Coordinating Ministry of People's welfare , NGOs and Local Community, PT Taman, Directorate of Archaeology and History</p>	<p>3 months</p> <p>On going</p> <p>On going</p> <p>3 months and periodically reviewed and updated</p> <p>On going Process</p> <p>On going Process</p> <p>6 months and periodic review</p> <p>6 months and periodic review</p> <p>6 months and periodic review</p>
--	--	---	--	---

		<p>departments / stakeholders</p> <ul style="list-style-type: none"> - Regular emergency drills <p>Development of pilot risk management plan (as example for other sites)</p>		
Research and Monitoring				
	<p>Lack of knowledge about 'hidden' damages and behavioral pattern of each structures especially with respect to earthquake forces.</p>	<p>Collection and Review of earlier Research by various national and international experts such as Unesco Stone experts 2004 report.</p> <p>Analysis of Structural Stability of individual structures,</p> <p>Decision on the location for detailed investigation of damage especially for understanding hidden damages.</p> <p>Condition assessment of RCC frames provided during earlier restoration works.</p> <p>Analysis of RCC consolidation of inner core for its affect on the damage.</p> <p>Analysis of the ground conditions/geological and seismological studies, archaeological aspects, geotechnical studies.</p> <p>Conservation Research (for materials) and development of appropriate technology for restoration and conservation</p> <p>Assessing current visitor management issues during the conservation work</p> <p>Cultural resource mapping process to begin (including documentation)</p> <p>Research on the traditional construction technology of the monuments</p>	<p>Identification of national expertise from institutions such as:</p> <p>UGM, National center for Earthquake Research (PUSLITBANG Geology Bandung, BP3 of different regions in the country, and other relevant stakeholders (to be identified)</p> <p>Dept. of culture and tourism.</p> <p>Research and Development Centre of Culture</p>	<p>Within 12 months</p> <p>(simultaneous actions along with other activities)</p> <p>Ongoing</p> <p>Ongoing</p>
	<p>Limited documentation of Siwa Temple before the earthquake (structure, material, architecture, details etc.)</p>	<p>Digitizing the existing documentation for further analysis.</p>	<p>Involving locally available expertise in various fields such as IT from UGM, BP3, Borobodur Conservation Center</p>	<p>6 months</p>

	Lack of documentation of Siwa on earlier restoration works/ other interventions on the structures / site e.g. paving etc.	Need for further investigation of structural and material damages/condition mapping - crack pattern, deformation, bulging, material damage, earlier restoration works and their dating	- BP3 and UGM	To be completed within 3 months
		Need for Instrumentation Installation for monitoring ground acceleration and structural stability	Dept. of Culture and Tourism, BP3 UGM (Remote Sensing)	3 Months and continuous monitoring afterwards, UNESCO and International Donors.
		Need for library research of Prambanan Temple complex with special reference to Siwa Temple	<ol style="list-style-type: none"> 1. Dept. of Culture and Tourism. 2. Department of Foreign Affairs, 3. Netherlands Embassy in Jakarta, 4. Indonesian Embassy in Netherlands. 	<p>Diplomatic Contact and locating relevant documents.</p> <p>Visit of Technical Person (if needed)</p> <p>(April to June 2007)</p>
	Need for computer 3 D modeling and simulation	<p>Involving locally available expertise in various fields such as IT from ITB, UGM, and other institutions/universities.</p> <p>Formulation of expert committee</p>	BP3, UGM, Dept. of Culture and Tourism, Association of Indonesian Architects, Association of Civil Engineers, LIPI	Commence within 3 months (short term)
Restoration & Conservation				
	Short Term:	<p>-Preparing buffer storage</p> <p>-Siwa Restoration methods should be included in national technical meeting.</p> <p>-Continuing to remove displace stones using traditional method</p> <p>-Preventing rain water penetration in the new cracks</p> <p>-Repairing the broken stones</p> <p>-Restoring South Apit Temple</p> <p>-Preparing North Apit Temple as an affected earthquake monument for public education</p> <p>-Widening South side visitor area</p> <p>-Restoring Garuda Temple</p>	<p>BP3, PT. Taman, local government of Klaten and Sleman.</p> <p>BP3, Department of Culture and Tourism, UGM,</p> <p>BP3, UGM, local community</p> <p>BP3, UGM</p> <p>BP3, Department of Culture and Tourism,</p> <p>BP3, UGM, PT. Taman, Department of Culture and Tourism,</p> <p>PT.Taman</p> <p>BP3, UGM, Department of Culture and Tourism,</p>	<p>-3 months (April-June)</p> <p>-On technical national meeting</p> <p>6 months</p> <p>Regularly every 6 months</p> <p>8 months (May-December)</p> <p>3 months</p> <p>2 months</p> <p>2 weeks (in May 2007)</p> <p>8 months</p>
	Middle Term	<p>-Restoring Nandi Temple</p> <p>-Restoring Angsa Temple</p>	<p>BP3, UGM, Department of Culture and Tourism,</p> <p>BP3, UGM, Department of Culture and Tourism,</p>	<p>8 months</p> <p>6 months</p>

	Long Term	<p>-Restoring Wisnu Temple</p> <p>-Restoring Brahma Temple</p> <p>-Rehabilitating Siwa Temple</p> <p>-Restoring the 1st wall and gate</p>	<p>BP3, UGM, Department of Culture and Tourism,</p> <p>BP3, UGM, Department of Culture and Tourism,</p> <p>BP3, UGM, Department of Culture and Tourism,</p> <p>BP3, UGM, Department of Culture and Tourism,</p>	<p>12 months</p> <p>16 months</p> <p>Based on the chosen method of restoration</p> <p>4 years</p>
	Capacity Building			
	<p>Lack of capacity among the local staff</p> <ul style="list-style-type: none"> - Monitoring the condition - Damage Assessment - Handling and Locating collapsed fragments - Conservation and Restoration Techniques - Risk Management - Visitor Management 	<p>Identification of target groups (archaeologists, conservators, engineers, managers, security staff, architects, volunteers e.g. university students, local community)</p> <p>Raising local public awareness by media campaigns on TV, Radio, visitor interpretation on the site, publications</p> <p>Need for periodic focused group discussions for the staff / on the various aspects identified (@ 3 months)</p> <p>Followed by thematic workshops</p>	<p>Electronic and Print Media</p> <p>NGOs</p> <p>Local Communities</p> <p>Department of Communication and Information</p> <p>Department of National Education esp. for the Youth</p> <p>Department of Youth and Sports</p> <p>Department of Culture and Tourism</p> <p>PT Taman</p> <p>BP3</p> <p>Local Government</p>	<p>3 Months (regularly)</p> <p>6 Months (regularly)</p>

APPENDIX I

BUDGET OF REHABILITATION

APPENDIX 1

BUDGET OF REHABILITATION

A GENERAL EQUIPMENT

I Scaffolding									
1	Pipe medium A Ø 3"	1,100			bar	x	Rp	700,000.00 = RP	770,000,000.00
2	Connector 3" (2 pipa)	2,000			unit	x	Rp	150,000.00 = RP	300,000,000.00
3	Beam 8/12 - 400	100			bar	x	Rp	250,000.00 = RP	25,000,000.00
4	Board 3/25 -400	100			piece	x	Rp	225,000.00 = RP	22,500,000.00
5	Stirrup	200			unit	x	Rp	25,000.00 = RP	5,000,000.00
6	Nail 2"	200			kg	x	Rp	8,000.00 = RP	1,600,000.00
II Work Equipment									
	Lift Provision	2			unit	x	Rp	1,500,000.00 = RP	3,000,000.00
III Infrastructure									
1 Stone Storage									
	Outdoor	2,000.00			m ²	x	Rp	50,000.00 = RP	100,000,000.00
	Indoor	300.00			m ²	x	Rp	300,000.00 = RP	90,000,000.00
2	Transportation route	100			m	x	Rp	50,000.00 = RP	5,000,000.00
3	Site Office	500			m ²	x	Rp	800,000.00 = RP	400,000,000.00
4	Material Storage	100			m ²	x	Rp	800,000.00 = RP	80,000,000.00
	Total							Rp	1,802,100,000.00

B REHABILITATION OF BRAHMA TEMPLE**I SALARIES**

1	Director	1	x	12	x	25	x	Rp	200,000.00 = RP	60,000,000.00
2	Team leader	1	x	12	x	25	x	Rp	175,000.00 = RP	52,500,000.00
3	Expert Archaeology	1	x	12	x	25	x	Rp	150,000.00 = RP	45,000,000.00
4	Expert Civil Engineer	2	x	12	x	25	x	Rp	150,000.00 = RP	90,000,000.00
5	Field Coordinator	1	x	12	x	25	x	Rp	75,000.00 = RP	22,500,000.00
6	Technician	10	x	12	x	25	x	Rp	60,000.00 = RP	180,000,000.00
7	Labor	60	x	12	x	25	x	Rp	50,000.00 = RP	900,000,000.00
8	Filed worker	15	x	12	x	25	x	Rp	40,000.00 = RP	180,000,000.00
9	Administration staff	4	x	12	x	25	x	Rp	40,000.00 = RP	48,000,000.00
10	Security	6	x	12	x	25	x	Rp	30,000.00 = RP	54,000,000.00
	Total								Rp	1,632,000,000.00

II EQUIPMENT**II.1 Restoration project**

1	Supporting equipment for dismantling	1			ls	x	Rp	9,500,000.00 = RP	9,500,000.00
2	Supporting equipment for anastilosis	1			ls	x	Rp	97,000.00 = RP	97,000.00
3	Supporting equipment for stone replacement	1			ls	x	Rp	4,200,000.00 = RP	4,200,000.00
4	Supporting equipment for detail carving	1			ls	x	Rp	1,300,000.00 = RP	1,300,000.00
5	Supporting equipment for trial reconstruction	1			ls	x	Rp	3,900,000.00 = RP	3,900,000.00
6	Supporting equipment for reconstruction	1			ls	x	Rp	7,000,000.00 = RP	7,000,000.00
	Total							Rp	25,997,000.00

II.2 Conservation project

1	Chisel	56			unit	x	Rp	10,000.00 = RP	560,000.00
2	Paint brush 2,5"	286			unit	x	Rp	7,500.00 = RP	2,145,000.00
3	Mask	98			unit	x	Rp	7,800.00 = RP	764,400.00
4	Brush (ijuk)	1,800			unit	x	Rp	7,500.00 = RP	13,500,000.00

II.2 Conservation project								
5	Bucket	60	unit	x	Rp	10,000.00 = RP	600,000.00	
6	Electric drill	2	unit	x	Rp	1,000,000.00 = RP	2,000,000.00	
7	Concrete drill	30	unit	x	Rp	10,000.00 = RP	300,000.00	
8	Injector	40	unit	x	Rp	5,000.00 = RP	200,000.00	
9	Tube	5	unit	x	Rp	15,000.00 = RP	75,000.00	
10	Scale	2	unit	x	Rp	250,000.00 = RP	500,000.00	
11	Trolley	2	unit	x	Rp	1,500,000.00 = RP	3,000,000.00	
12	Tube Φ 18 mm	2	roll	x	Rp	780,000.00 = RP	1,560,000.00	
13	water pump	2	unit	x	Rp	2,350,000.00 = RP	4,700,000.00	
14	Scafel	15	unit	x	Rp	47,000.00 = RP	705,000.00	
15	Tray	15	unit	x	Rp	5,000.00 = RP	75,000.00	
16	Hammer	10	unit	x	Rp	15,000.00 = RP	150,000.00	
17	Electricity	1	ls	x	Rp	15,334,000.00 = RP	15,334,000.00	
	Total					Rp	46,168,400.00	
III Material								
III.1 Restoration Material								
1	Andesit stone	1,079	block	x	Rp	180,000.00 = RP	194,220,000.00	
2	Stone	50	m ³	x	Rp	90,000.00 = RP	4,500,000.00	
3	Cement	143	zack	x	Rp	30,000.00 = RP	4,290,000.00	
4	Sand	23	m ³	x	Rp	125,000.00 = RP	2,875,000.00	
5	Lighting conductor clamp	84	m	x	Rp	75,000.00 = RP	6,300,000.00	
6	Lighting conductor wire	120	m	x	Rp	22,000.00 = RP	2,640,000.00	
7	Diesel Fuel	1,600	liter	x	Rp	4,500.00 = RP	7,200,000.00	
8	Rotella oil	20	gallon	x	Rp	150,000.00 = RP	3,000,000.00	
	Total					Rp	225,025,000.00	
III.2 Conservation material								
1	Wall paint	2	kg	x	Rp	15,000.00 = RP	30,000.00	
2	Plastic bag	10	pack	x	Rp	3,000.00 = RP	30,000.00	
3	A C 322	420	kg	x	Rp	225,000.00 = RP	94,500,000.00	
4	Mill	116	kg	x	Rp	3,000.00 = RP	348,000.00	
5	Sikadur 31	3,436	kg	x	Rp	105,225.00 = RP	361,553,100.00	
6	Brass dowel	143	m	x	Rp	75,000.00 = RP	10,725,000.00	
7	Icosit Aqua stop	928	liter	x	Rp	90,000.00 = RP	83,520,000.00	
8	Rhodorsil RC 90	12	liter	x	Rp	350,000.00 = RP	4,200,000.00	
9	Epoxy resin EPIS	3	liter	x	Rp	1,000,000.00 = RP	3,000,000.00	
10	Was	3	kg	x	Rp	10,000.00 = RP	30,000.00	
11	Resin Yukalac	27	kg	x	Rp	80,250.00 = RP	2,166,750.00	
12	Sand	1	m ³	x	Rp	150,000.00 = RP	150,000.00	
	Total					Rp	560,252,850.00	
IV	Documentation	1	ls	x	Rp	25,000,000.00 = RP	25,000,000.00	
V	Others	1	ls	x	Rp	50,000,000.00 = RP	50,000,000.00	
Total amount for rehabilitation of Brahma temple							Rp	2,564,443,250.00

C REHABILITATION OF WISNU TEMPLE**I SALARIES**

1	Director	1	x	14	x	25	x	Rp	200,000.00 = RP	70,000,000.00
2	Team leader	1	x	14	x	25	x	Rp	175,000.00 = RP	61,250,000.00
3	Expert Archaeology	1	x	14	x	25	x	Rp	150,000.00 = RP	52,500,000.00
4	Expert Civil Engineer	2	x	14	x	25	x	Rp	150,000.00 = RP	105,000,000.00
5	Field Coordinator	1	x	14	x	25	x	Rp	75,000.00 = RP	26,250,000.00
6	Technician	8	x	14	x	25	x	Rp	60,000.00 = RP	168,000,000.00
7	Labor	45	x	14	x	25	x	Rp	50,000.00 = RP	787,500,000.00
8	Filed worker	15	x	14	x	25	x	Rp	40,000.00 = RP	210,000,000.00
9	Administration staff	4	x	14	x	25	x	Rp	40,000.00 = RP	56,000,000.00
10	Security	6	x	14	x	25	x	Rp	30,000.00 = RP	63,000,000.00
	Total								Rp	1,599,500,000.00

II EQUIPMENT**II.1 Restoration project**

1	Supporting equipment for dismantling	1				ls	x	Rp	6,100,000.00 = RP	6,100,000.00
2	Supporting equipment for anastilosis	1				ls	x	Rp	52,000.00 = RP	52,000.00
3	Supporting equipment for stone replacement	1				ls	x	Rp	527,000.00 = RP	527,000.00
4	Supporting equipment for detail carving	1				ls	x	Rp	536,000.00 = RP	536,000.00
5	Supporting equipment for trial reconstruction	1				ls	x	Rp	2,500,000.00 = RP	2,500,000.00
6	Supporting equipment for reconstruction	1				ls	x	Rp	4,400,000.00 = RP	4,400,000.00
	Total								Rp	14,115,000.00

II.2 Conservation project

1	Chisel	46				unit	x	Rp	10,000.00 = RP	460,000.00
2	Paint brush 2,5"	180				unit	x	Rp	7,500.00 = RP	1,350,000.00
3	Mask	85				unit	x	Rp	7,800.00 = RP	663,000.00
4	Brush (ijuk)	1,600				unit	x	Rp	7,500.00 = RP	12,000,000.00
5	Bucket	53				unit	x	Rp	10,000.00 = RP	530,000.00
6	Electric drill	2				unit	x	Rp	1,000,000.00 = RP	2,000,000.00
7	Concrete drill	15				unit	x	Rp	10,000.00 = RP	150,000.00
8	Injector	35				unit	x	Rp	5,000.00 = RP	175,000.00
9	Tube	5				unit	x	Rp	15,000.00 = RP	75,000.00
10	Scale	2				unit	x	Rp	250,000.00 = RP	500,000.00
11	Trolley	2				unit	x	Rp	1,500,000.00 = RP	3,000,000.00
12	Tube Φ 18 mm	2				rool	x	Rp	780,000.00 = RP	1,560,000.00
13	water pump	2				unit	x	Rp	2,350,000.00 = RP	4,700,000.00
14	Scafel	15				unit	x	Rp	47,000.00 = RP	705,000.00
15	Tray	15				unit	x	Rp	5,000.00 = RP	75,000.00
16	Hammer	10				unit	x	Rp	15,000.00 = RP	150,000.00
17	Electricity	1				ls	x	Rp	13,200,000.00 = RP	13,200,000.00
	Total								Rp	41,293,000.00

III Material**III.1 Restoration Material**

1	Andesit stone	150				block	x	Rp	180,000.00 = RP	27,000,000.00
2	Stone	24				m ³	x	Rp	90,000.00 = RP	2,160,000.00
3	Cement	218				zack	x	Rp	30,000.00 = RP	6,540,000.00
4	Sand	36				m ³	x	Rp	125,000.00 = RP	4,500,000.00
5	Lighting conductor clamp	84				m	x	Rp	75,000.00 = RP	6,300,000.00
6	Lighting conductor wire	120				m	x	Rp	22,000.00 = RP	2,640,000.00

III.1 Restoration Material						
7	Concrete steel	1,500	kg	x	Rp	8,000.00 = RP 12,000,000.00
8	Milled stones	30	m ³	x	Rp	150,000.00 = RP 4,500,000.00
7	Diesel fuel	1,750	liter	x	Rp	4,500.00 = RP 7,875,000.00
8	Rotella oil	24	gallon	x	Rp	150,000.00 = RP 3,600,000.00
	Total					Rp 77,115,000.00
III.2 Conservation material						
1	Wall paint	2	kg	x	Rp	15,000.00 = RP 30,000.00
2	Plastic bag	10	pack	x	Rp	3,000.00 = RP 30,000.00
3	A C 322	372	kg	x	Rp	225,000.00 = RP 83,700,000.00
4	Mill	116	kg	x	Rp	3,000.00 = RP 348,000.00
5	Sikadur 31	3,120	kg	x	Rp	105,225.00 = RP 328,302,000.00
6	Brass dowel	143	m	x	Rp	75,000.00 = RP 10,725,000.00
7	Icosit Aqua stop	928	liter	x	Rp	90,000.00 = RP 83,520,000.00
8	Rhodorsil RC 90	11	liter	x	Rp	350,000.00 = RP 3,850,000.00
9	Epoxy resin EPIS	3	liter	x	Rp	1,000,000.00 = RP 3,000,000.00
10	Was	3	kg	x	Rp	10,000.00 = RP 30,000.00
11	Resin Yukalac	27	kg	x	Rp	80,250.00 = RP 2,166,750.00
12	Sand	1	m ³	x	Rp	150,000.00 = RP 150,000.00
13	Araldite tar	175	kg	x	Rp	240,250.00 = RP 42,043,750.00
14	Aceton	30	liter	x	Rp	30,000.00 = RP 900,000.00
	Total					Rp 558,795,500.00
IV	Documentation	1	ls	x	Rp	22,000,000.00 = RP 22,000,000.00
V	Others	1	ls	x	Rp	44,000,000.00 = RP 44,000,000.00
Total amount for rehabilitation of Wisnu temple						Rp 2,356,818,500.00

RECAPITULATION

A	GENERAL EQUIPMENT	Rp	1,802,100,000.00
B	Brahma temple		
I	SALARIES	Rp	1,632,000,000.00
II	EQUIPMENT		
1	Restoration	Rp	25,997,000.00
2	Conservation	Rp	46,168,400.00
III	MATERIAL		
1	Restoration	Rp	225,025,000.00
2	Conservation	Rp	560,252,850.00
IV	DOCUMENTATION	Rp	25,000,000.00
V	OTHERS	Rp	50,000,000.00
C	Wisnu temple		
I	SALARIES	Rp	1,599,500,000.00
II	EQUIPMENT		
1	Restoration	Rp	14,115,000.00
2	Conservation	Rp	41,293,000.00
III	MATERIAL		
1	Restoration	Rp	77,115,000.00
2	Conservation	Rp	558,795,500.00
IV	DOCUMENTATION	Rp	22,000,000.00
V	OTHERS	Rp	44,000,000.00
	Total amount	Rp	6,723,361,750.00

APPENDIX II

MAP OF PRAMBANAN TEMPLE COMPOUND

Opak river

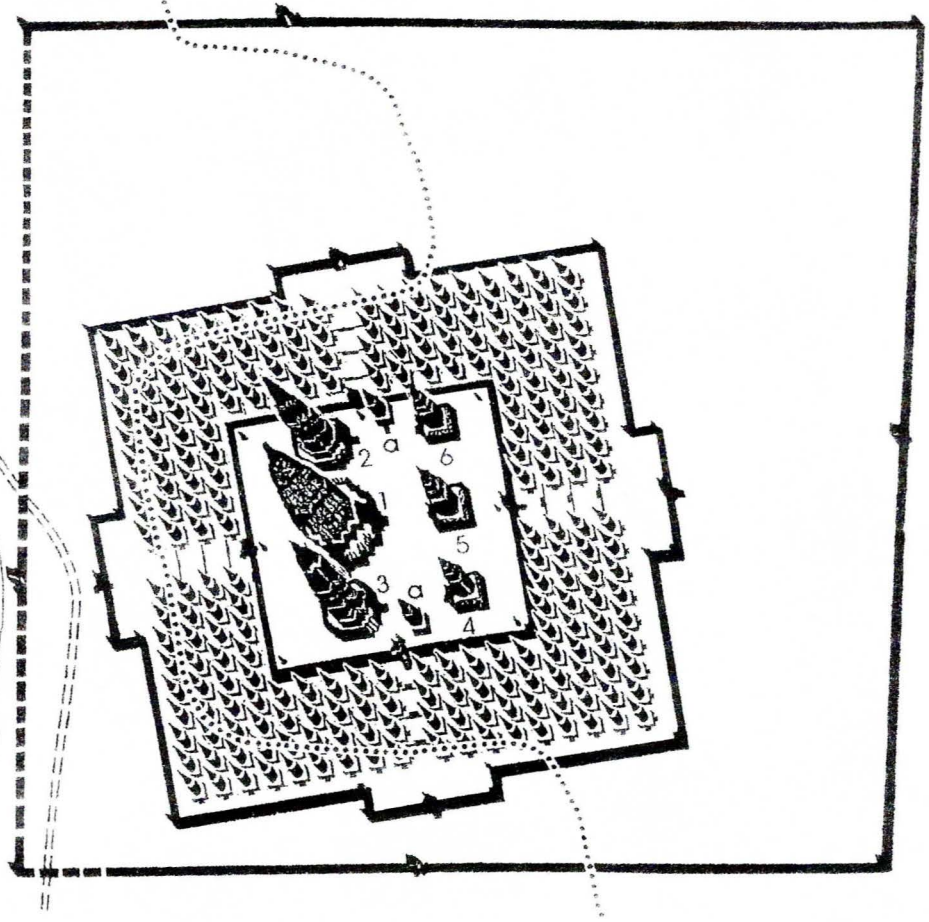
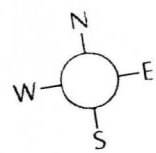

Map of Prambanan Temple Compound

APPENDIX III

CRACKING AND OPEN JOINT STONES ON SIWA TEMPLE

Candi Siwa
Kaki I dan Pagar Langkan
(Base Siwa 1 and balustrade)

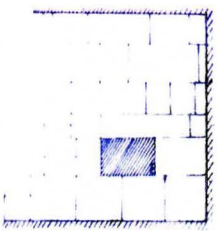

DETAIL A

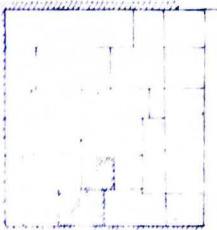

DETAIL B

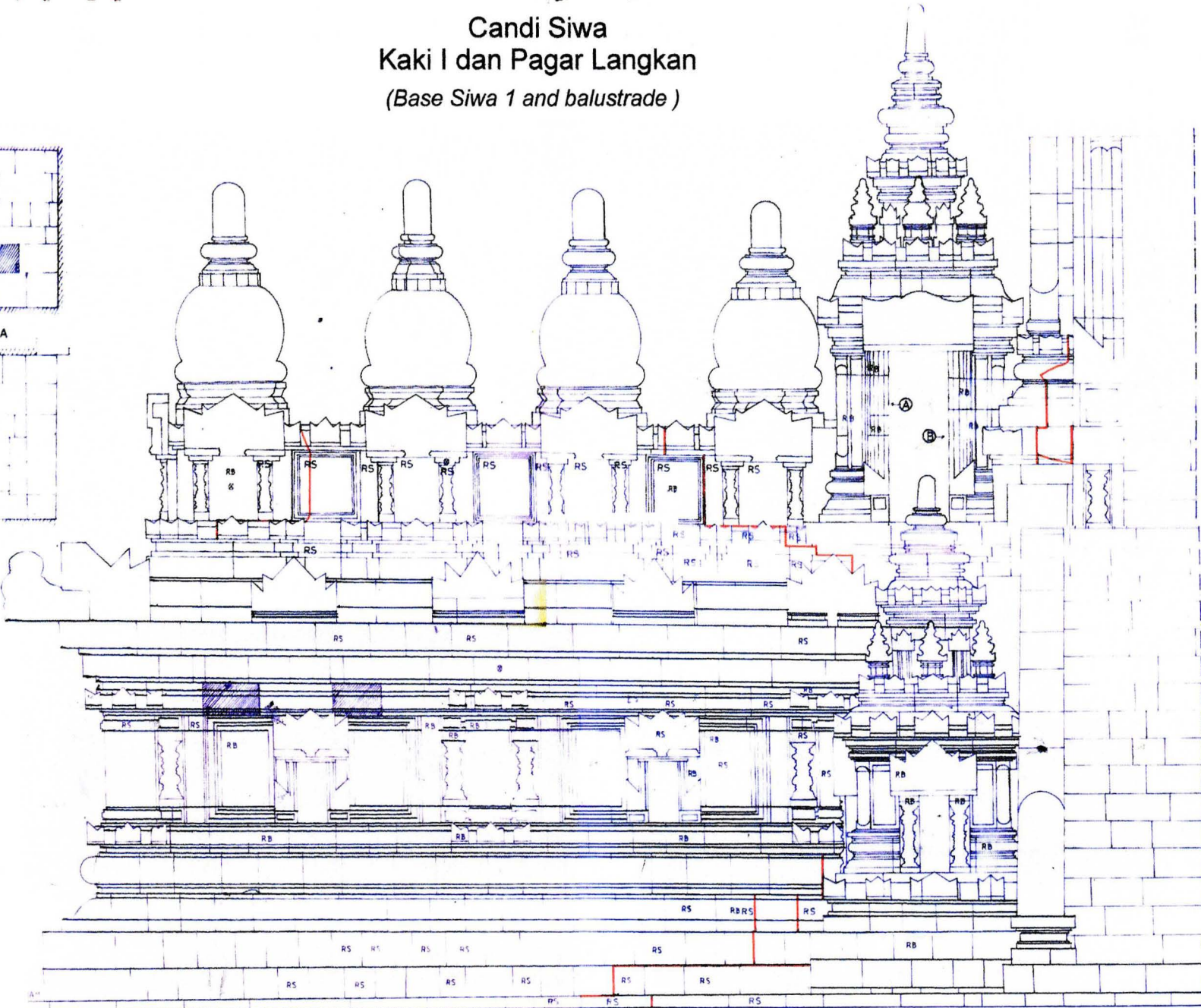

Bidang I
(Section 1)

KONSOLIDASI CAKDI 5 V.1
KAKI DAN PAGAR LENGKAP



Siwa temple consolidation
(Base Siwa 1 and balustrade)

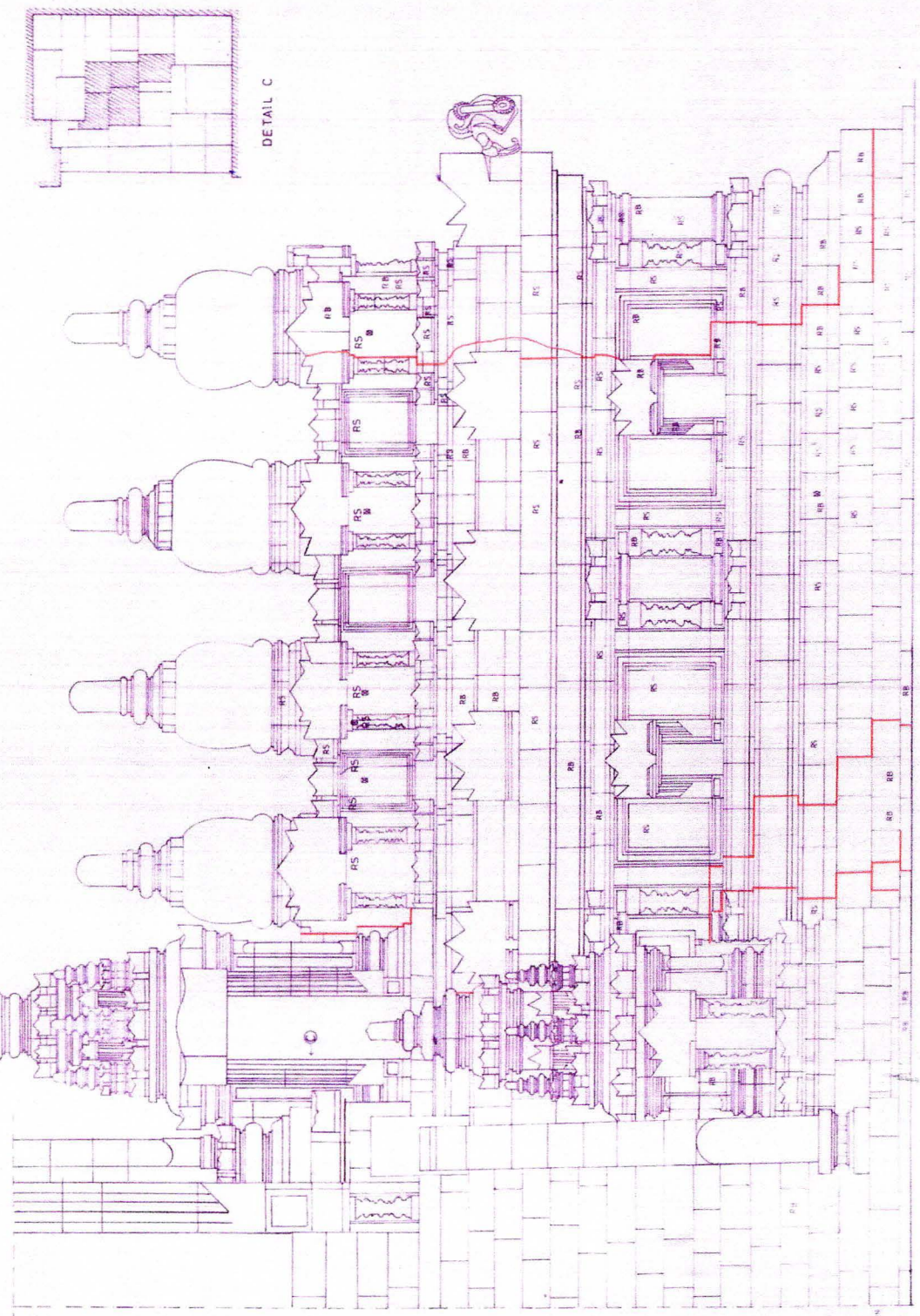

KETERANGAN

- BATU PERGIKAT TERBUK
- INTAKSI BATA RUTAS
- KONSOLIDASI BATU BESI
- ANGGARAN DUA IN. JARI

BIDANG 1

(Section 1)

Candi Siwa
Kaki I dan Pagar Langkan
(Base Siwa 1 and balustrade)

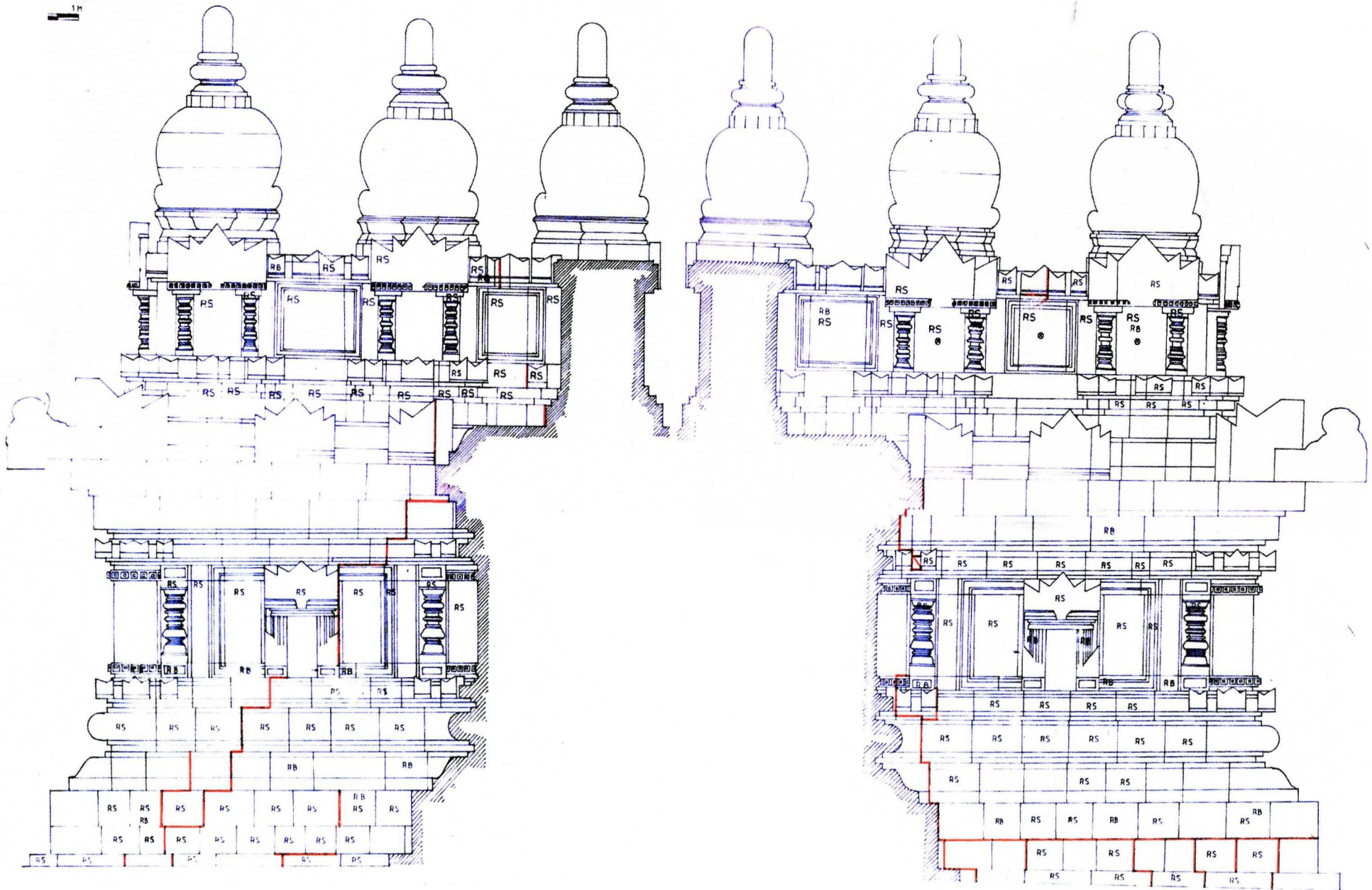

Bidang 3
(Section 3)

Bidang 2
(Section 2)

Candi Siwa
Kaki I dan Pagar Langkan
(Base I and balustrade of Siwa temple)

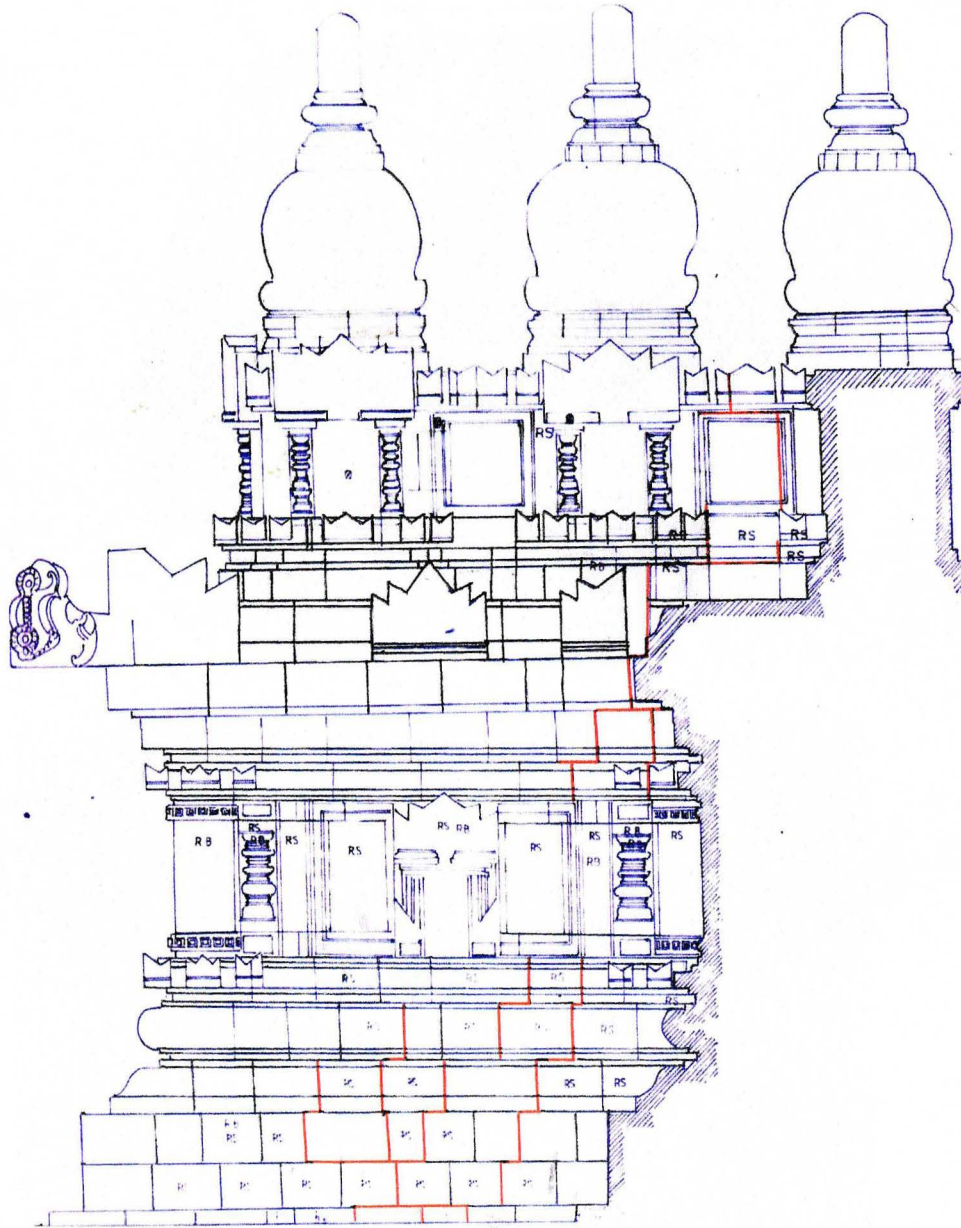

Bidang 5
(Section 5)

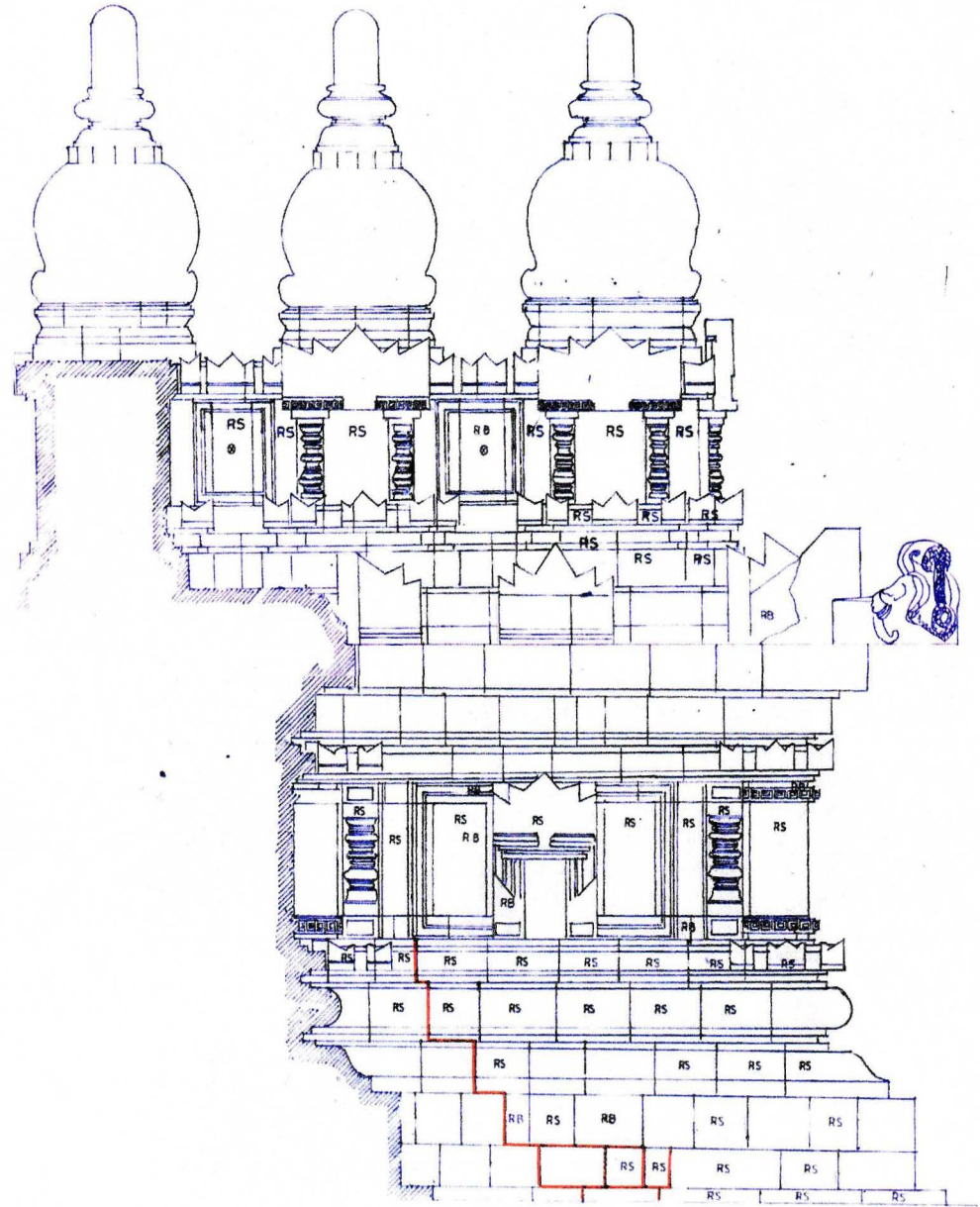

Bidang 4
(Section 4)

KONSOLIDASI CANDI SIWA
KAKI 1 DAN PAGAR LANJIPAN

Siwa temple consolidation Base Siwa 1 and Balustrade

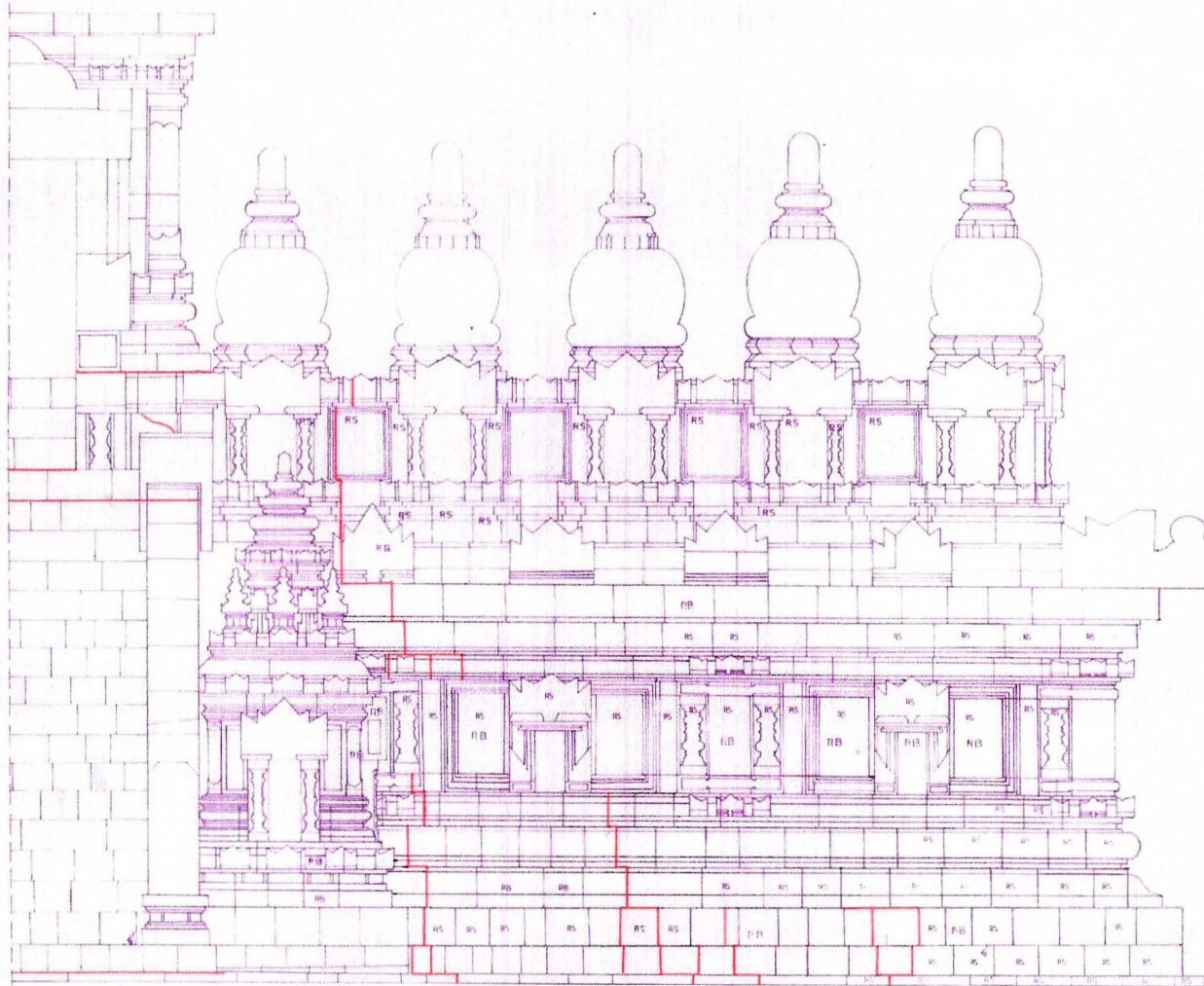

KETERANGAN
[RB] BALOK DATU RAPUH
[RS] PEMERIAN ENDAPAN GARAM

REKAMING 6
Section 6

KONSOLIDASI CANDI SIWA
KAKI DAN PAGAR LANGKAN



Siwa temple consolidation
Base Siwa 1 and Balustrade

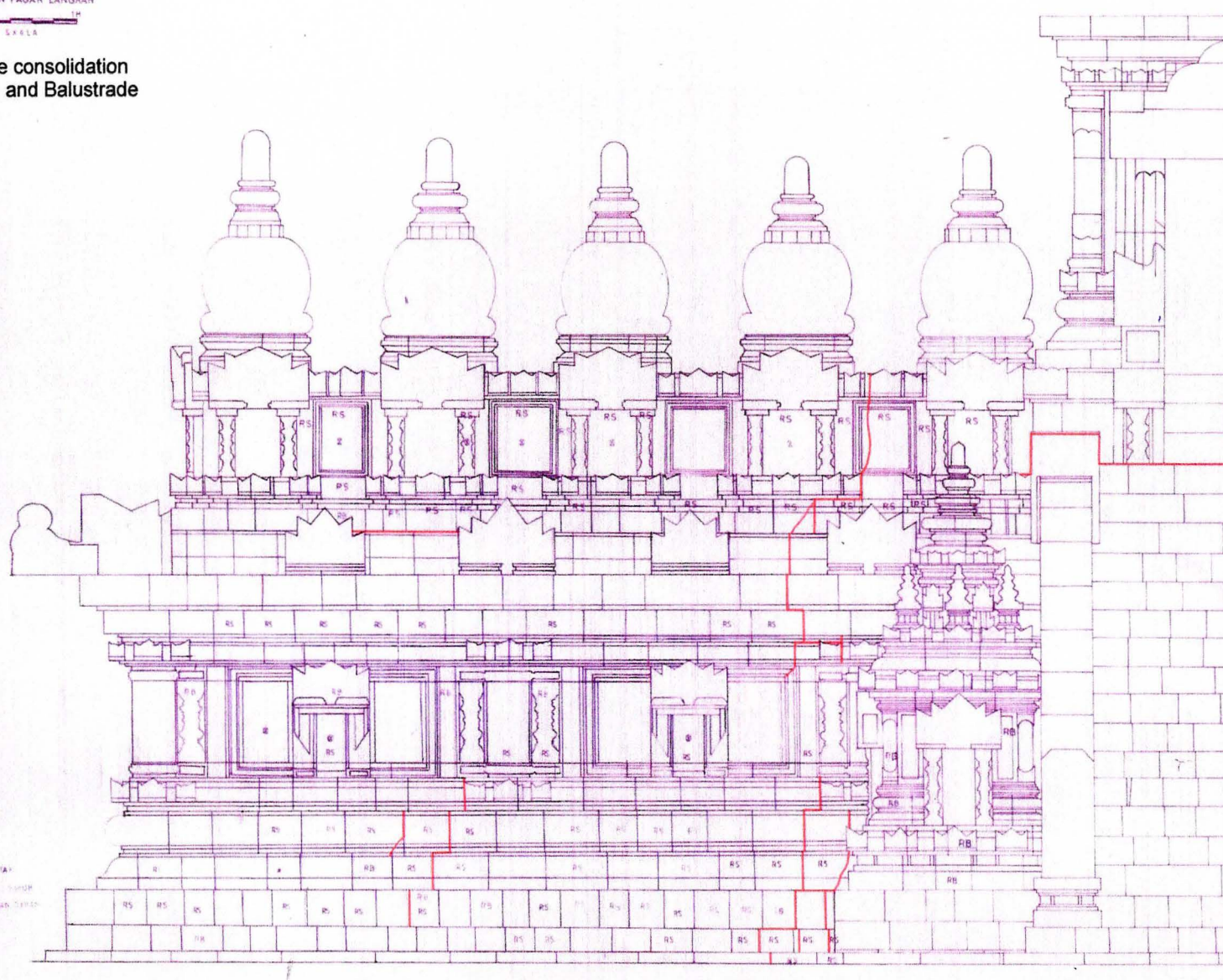

- REFERENSI
- (RS) BLOK BATU PASIR
 - (RB) ZONKOR 10/10/10/10/10
 - (PS) BENTUKAN ENDAPAN TUMBUH

BIDANG 6
(Section 6)

Candi Siwa
Kaki I dan Pagar Langkan
(Base Siwa 1 and balustrade)

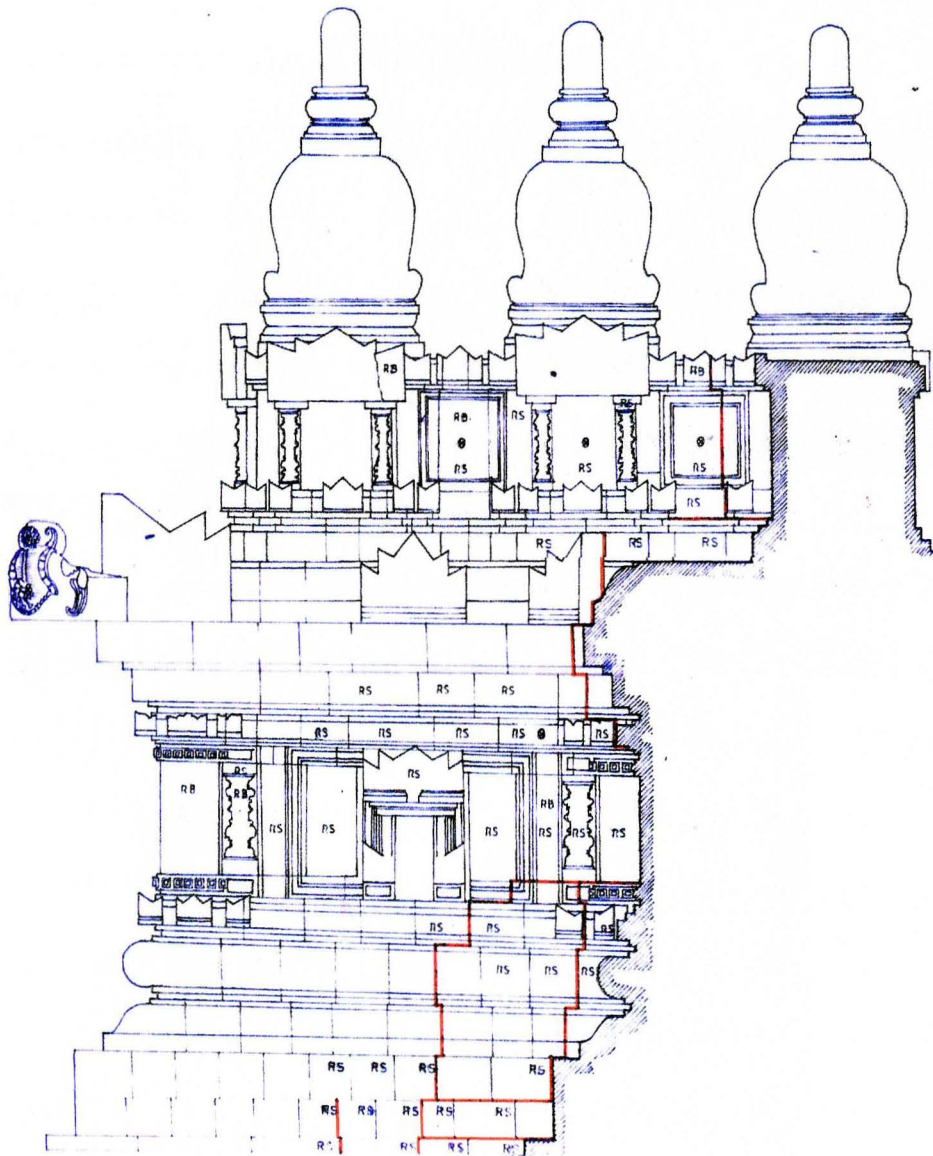

Bidang 8
(Section 8)

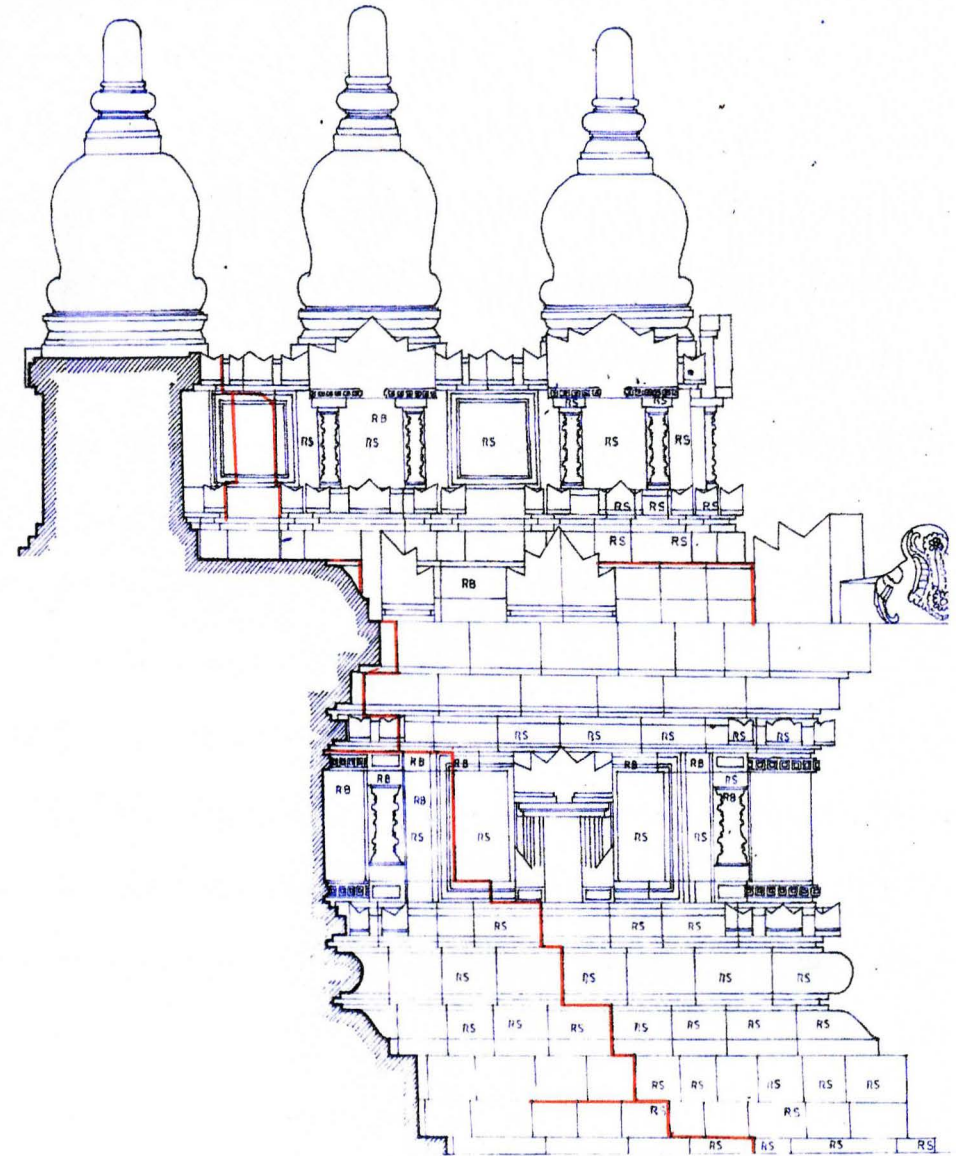

Bidang 7
(Section 7)

Candi Siwa
Kaki I dan Pagar Langkan
(Basement 1 and balustrade of Siwa temple)

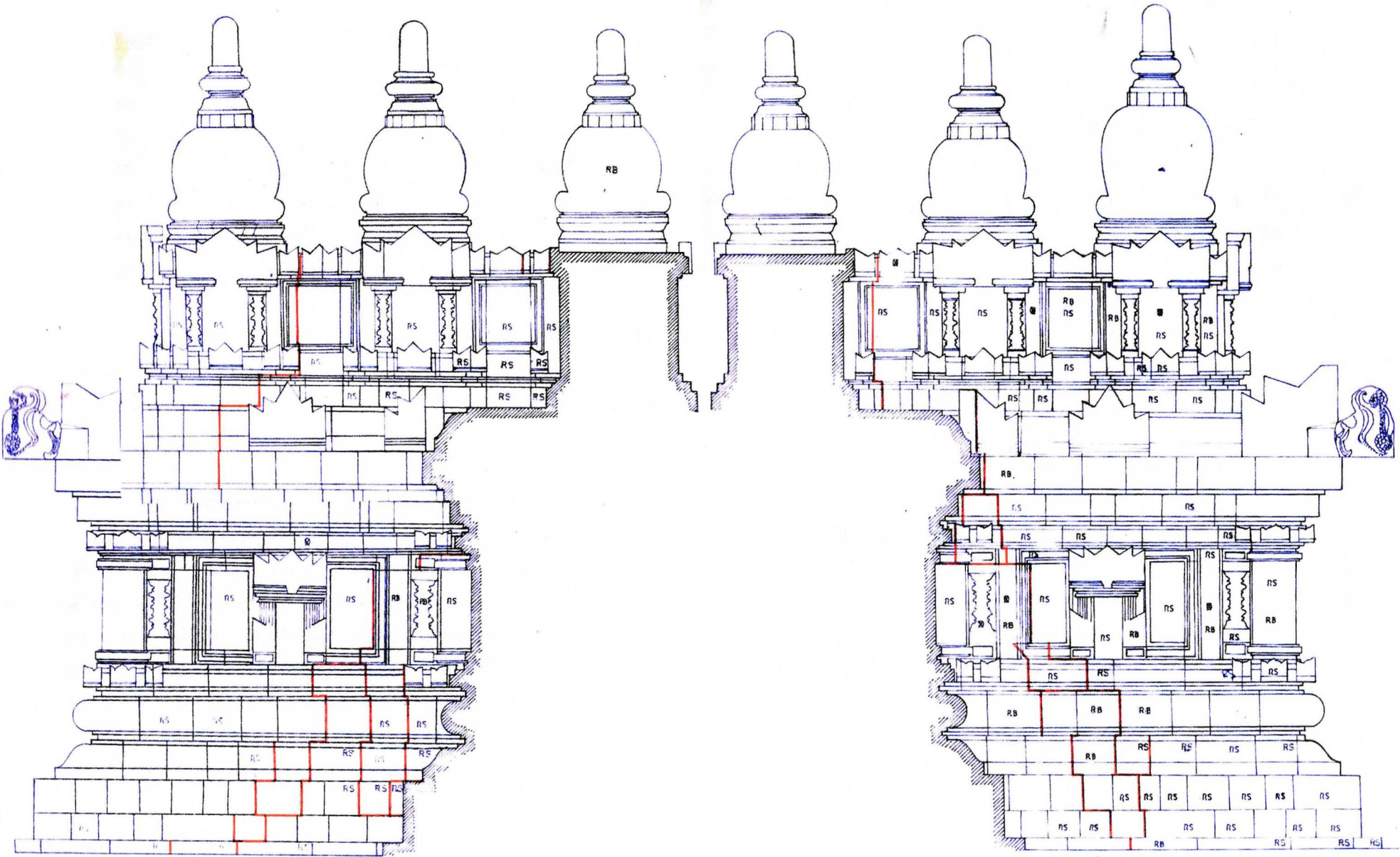

Bidang 10
(Section 10)

Bidang 9
(Section 9)

Candi Siwa
Kaki I dan Pagar Langkan
(Base Siwa 1 and balustrade)

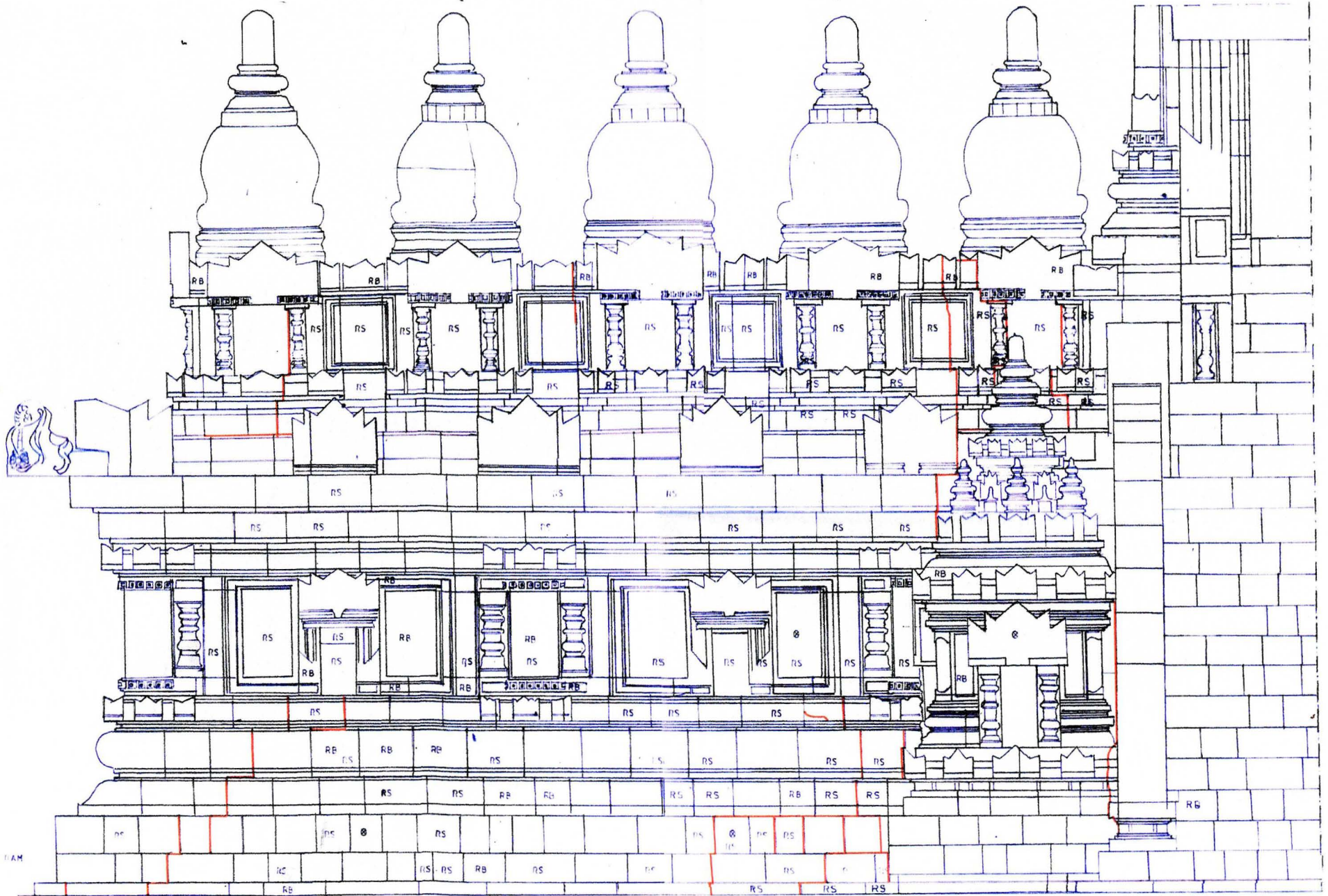

Bidang 11

KONSOLIDASI CANDI SIWA
KAKI I DAN PAGAR LANGKAN

Siwa temple consolidation
Base Siwa I and Balustrade

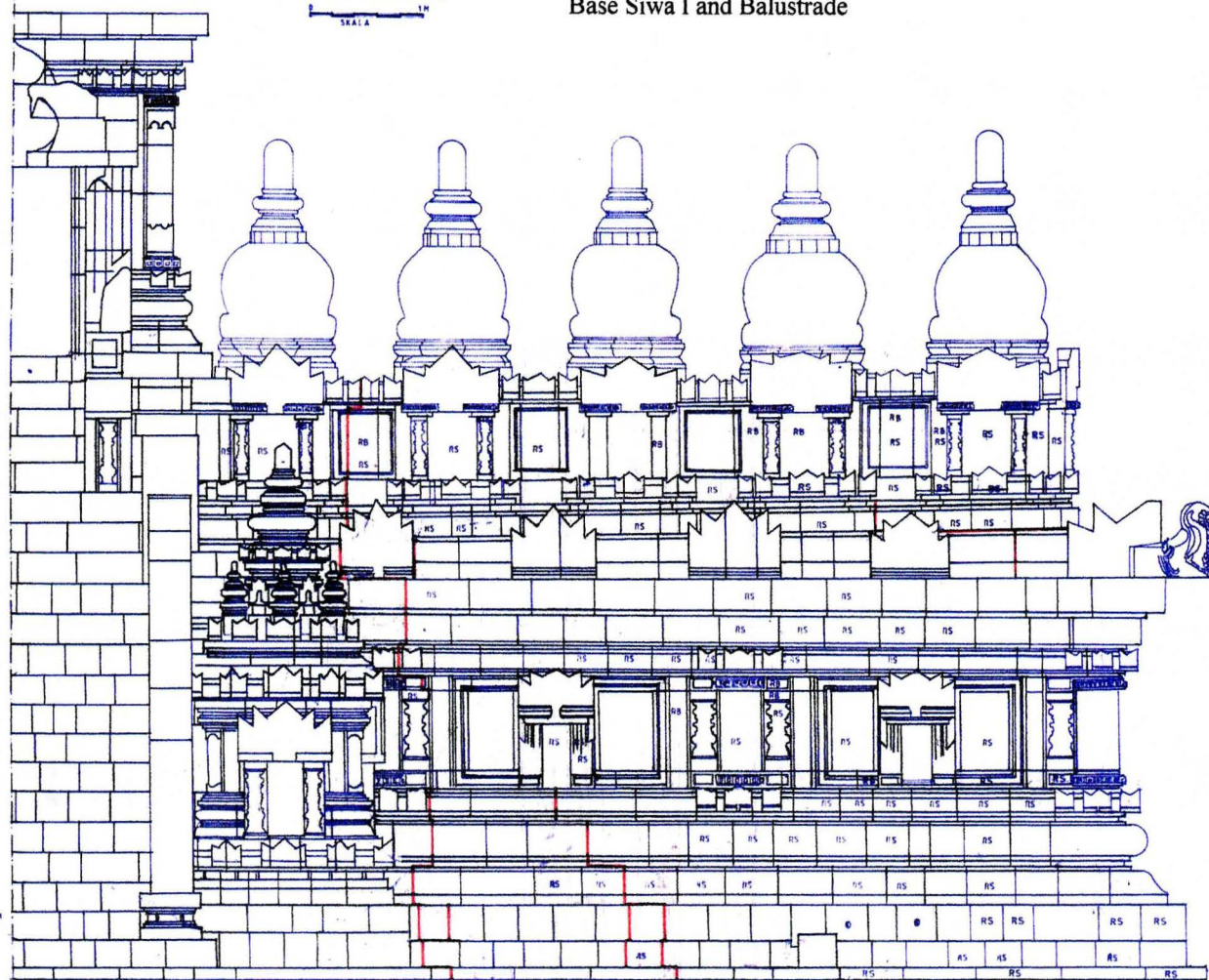

- KETERANGAN
- RB INJEKSI BATU RETAK
 - RS KONSOLIDASI BATU RAPUH
 - K PERISIAN EMPAN GAPAN

RIDANG XI
SEBELAH SELATAN
Section 11

Candi Siwa
Kaki I dan Pagar Langkan
(Base 1 and balustrade of Siwa temple)

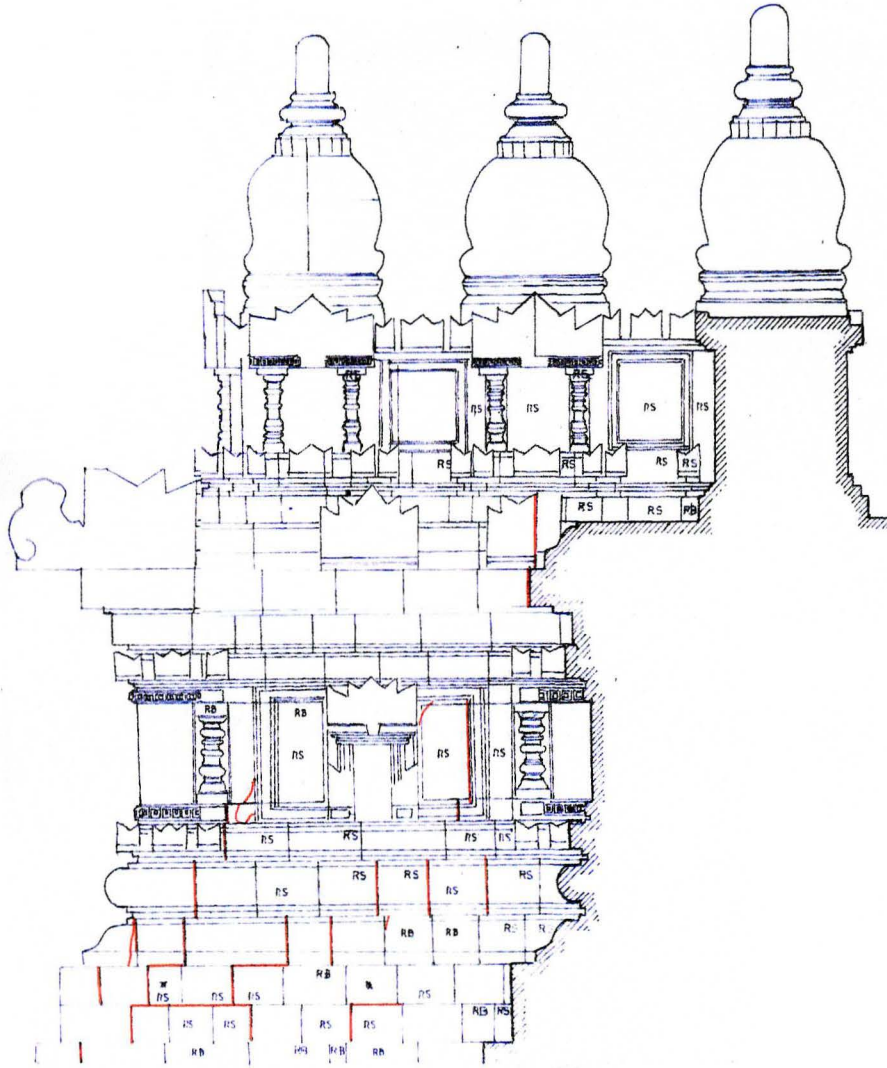

Bidang 13
(Section 13)

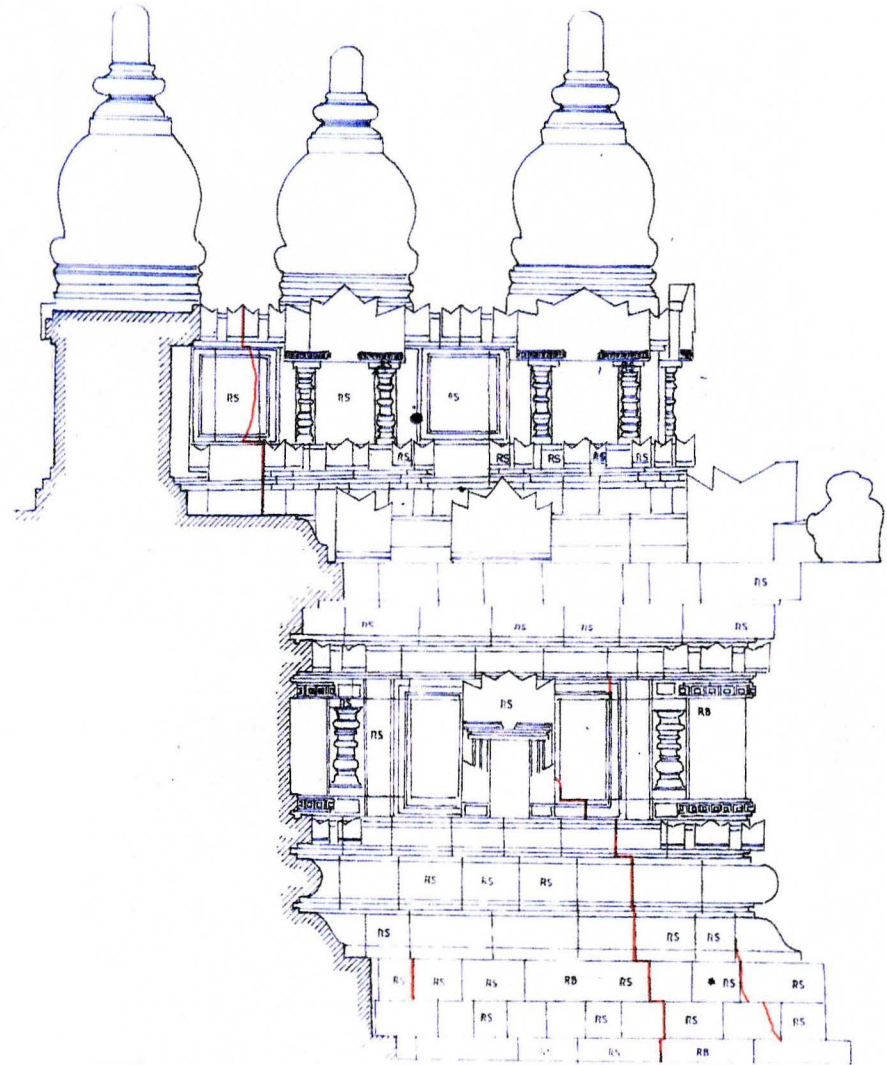

Bidang 12
(Section 12)

Candi Siwa,
Kaki I dan Pagar Langkan
(Base 1 and balustrade of Siwa temple)

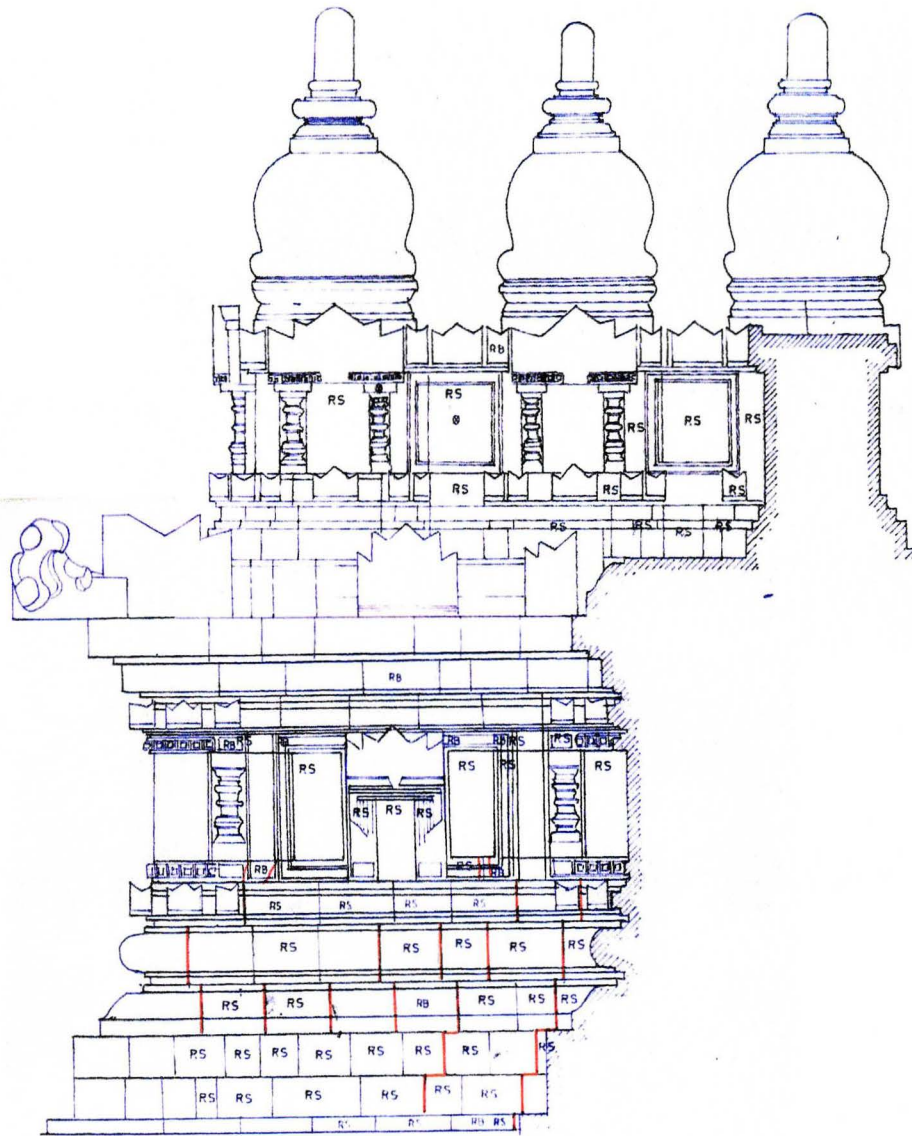

Bidang 15
(Section 15)

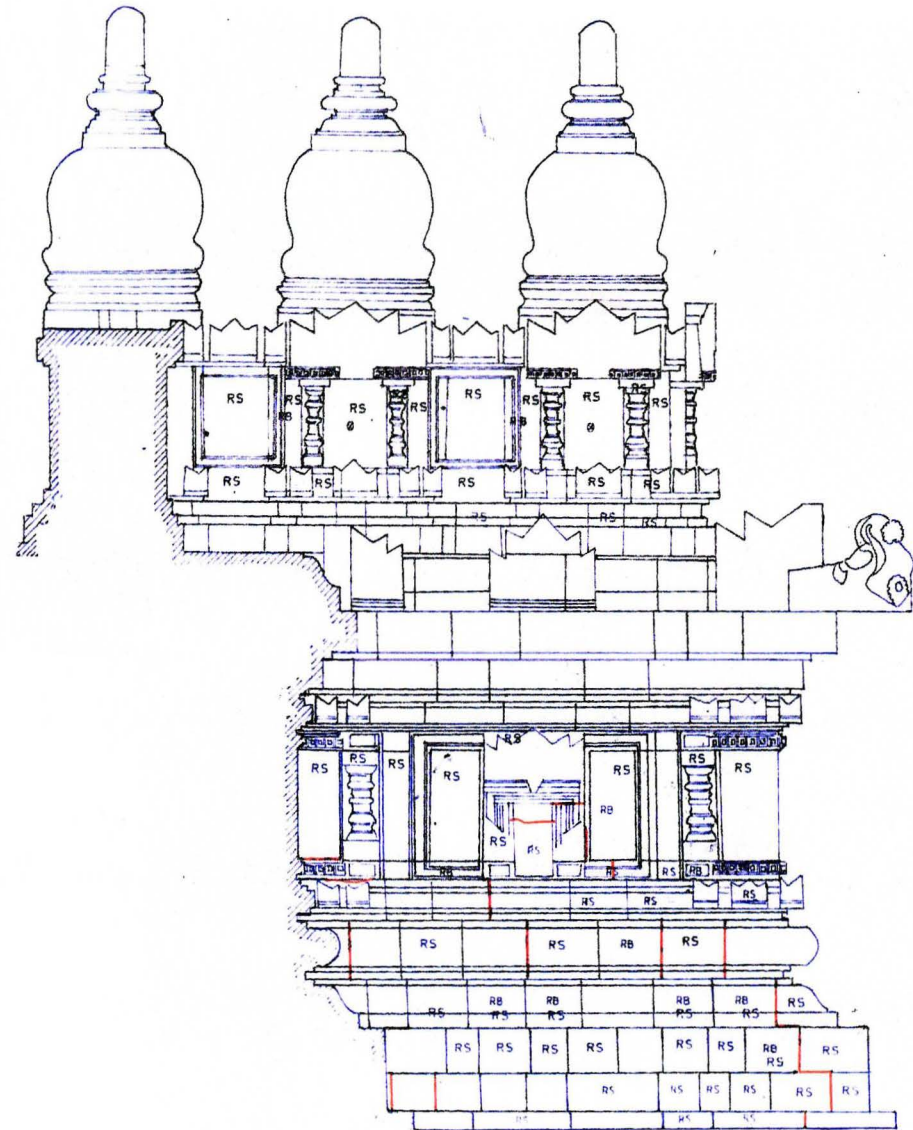

Bidang 14
(Section 14)

KONSOLIDASI CANDI SIWA
KARTI DAN PADAR LANGKAN



Siwa temple consolidation Base Siwa 1 and Balustrade

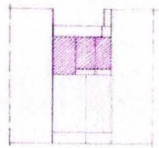

DETAIL A
TAMPAK ATAS

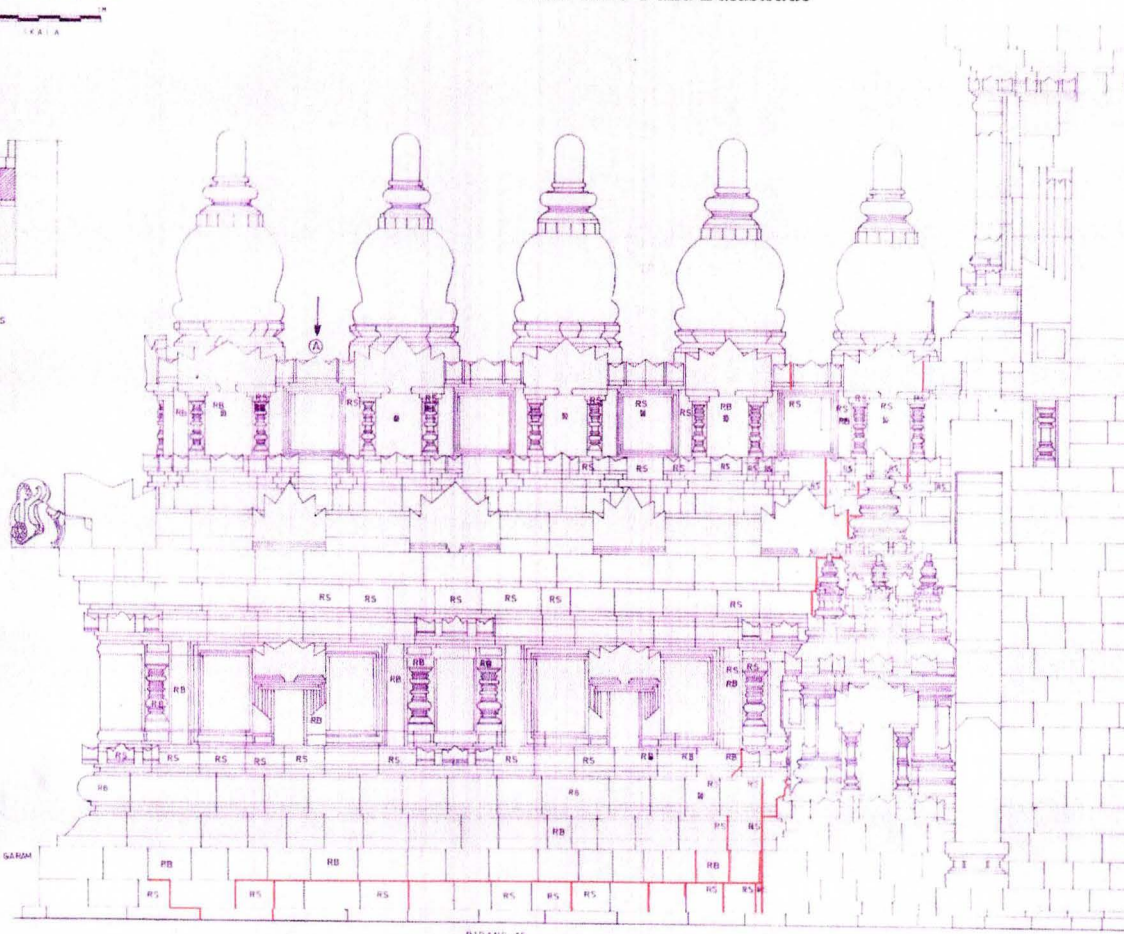

- LEJENDAR
- RS (RS) BATA BETON
 - RB (RB) KONSOLIDASI BATA RAPUH
 - RS (RS) BATA PINGGAL
 - RS (RS) PEMBERSIHAN ENDAPAN GAMB

BIDANG 16
Section 16

Candi Siwa
Kaki I dan Pagar Langkan
(Base Siwa 1 and balustrade)

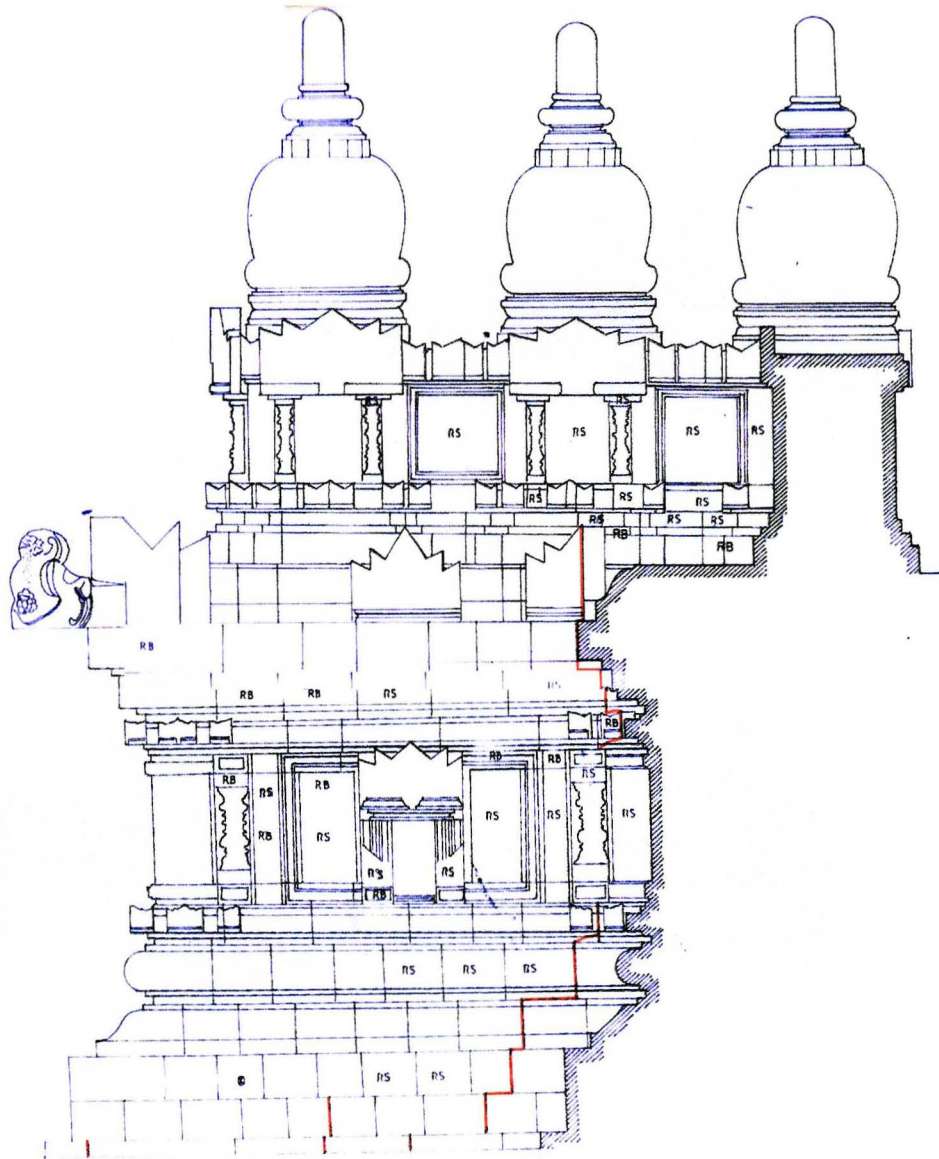

Bidang 20
(Section 20)

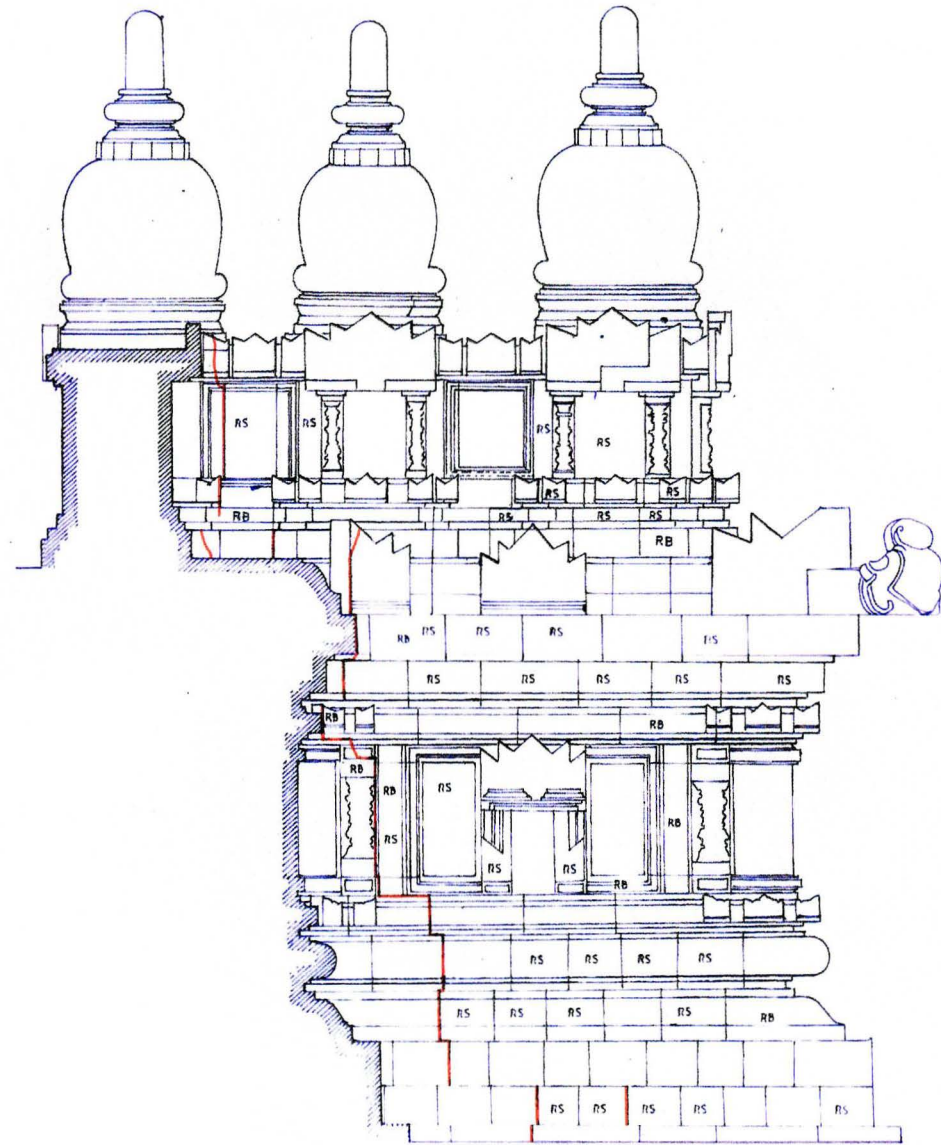

Bidang 19
(Section 19)

Siwa Temple Base Part Level II

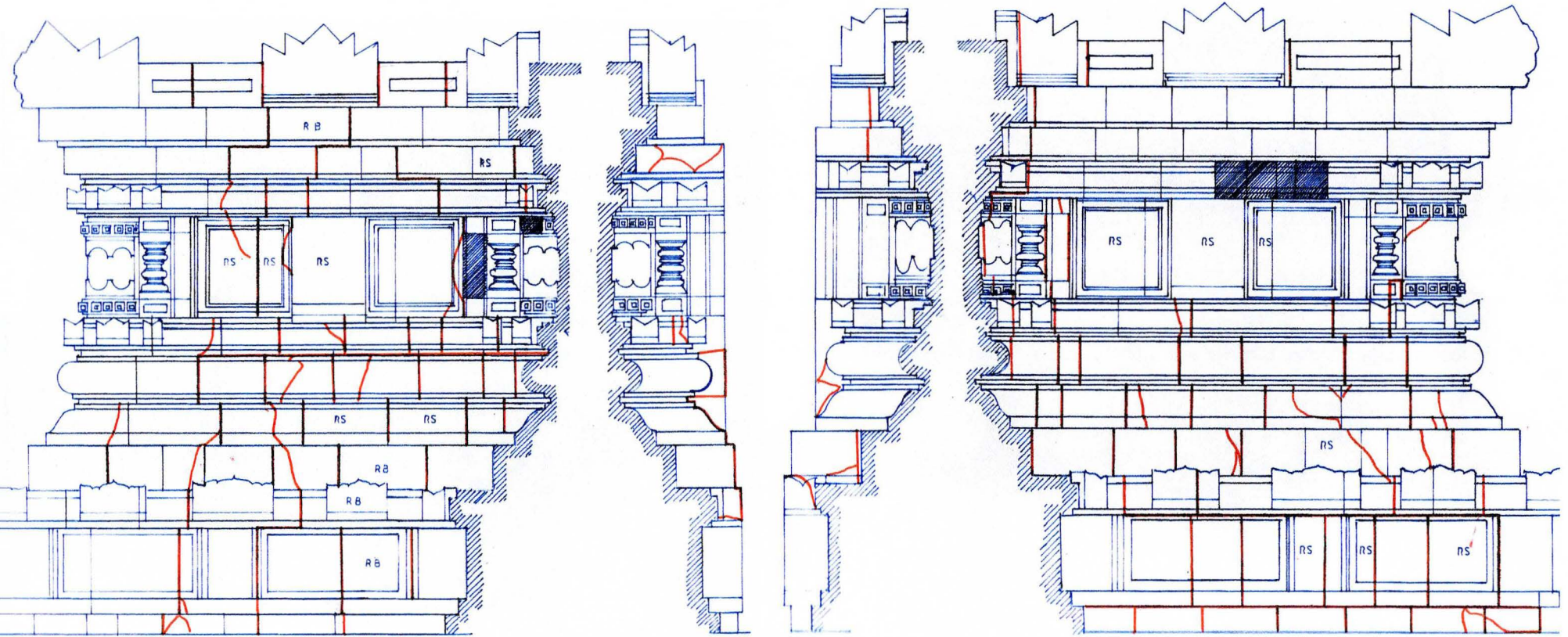

Remark



Cracking and open joint stone

Area I

Siwa Temple Base Part Level II

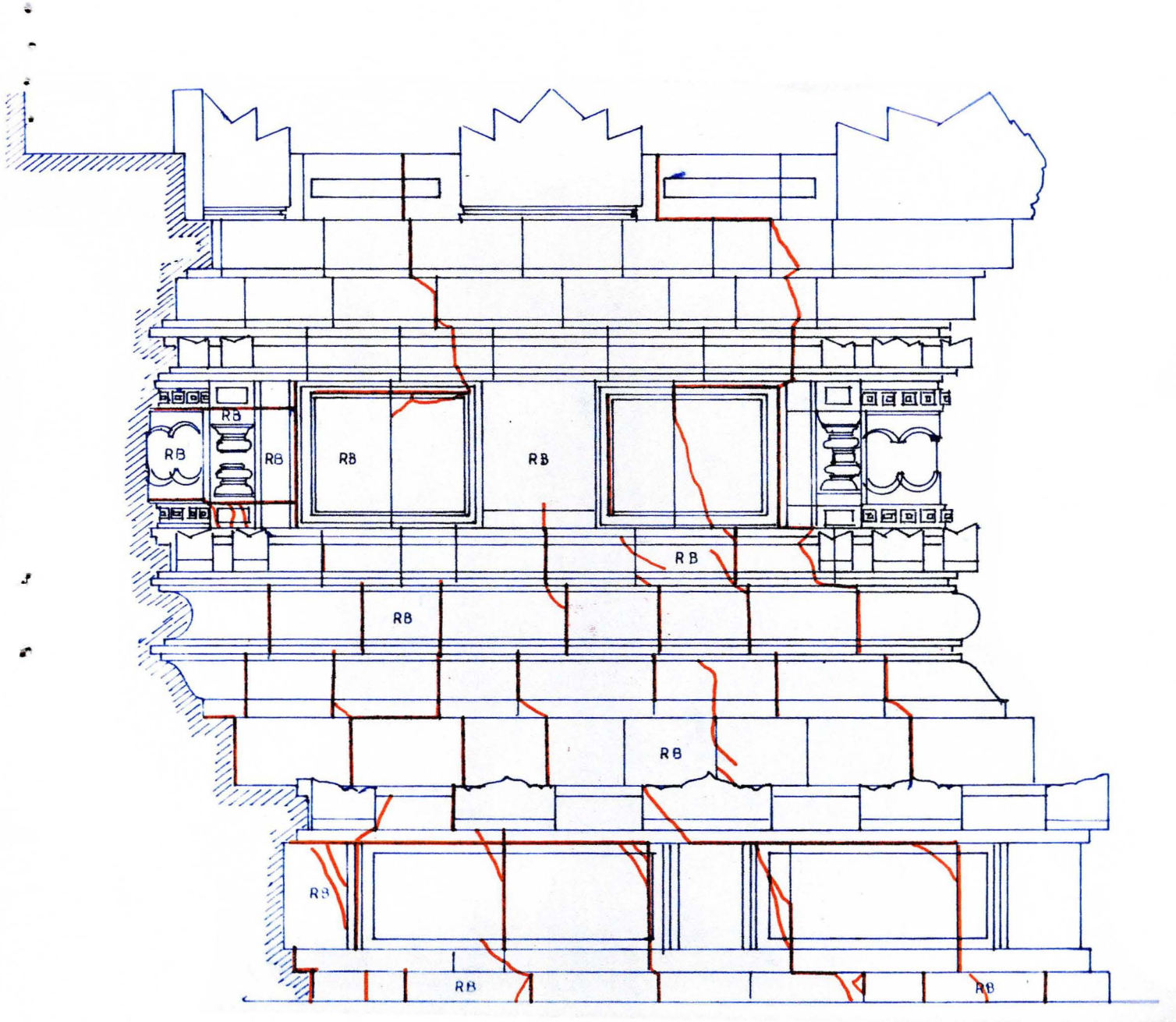

Area II

Remark

— Cracking and open joint stone

Siwa Temple Base Part Level II

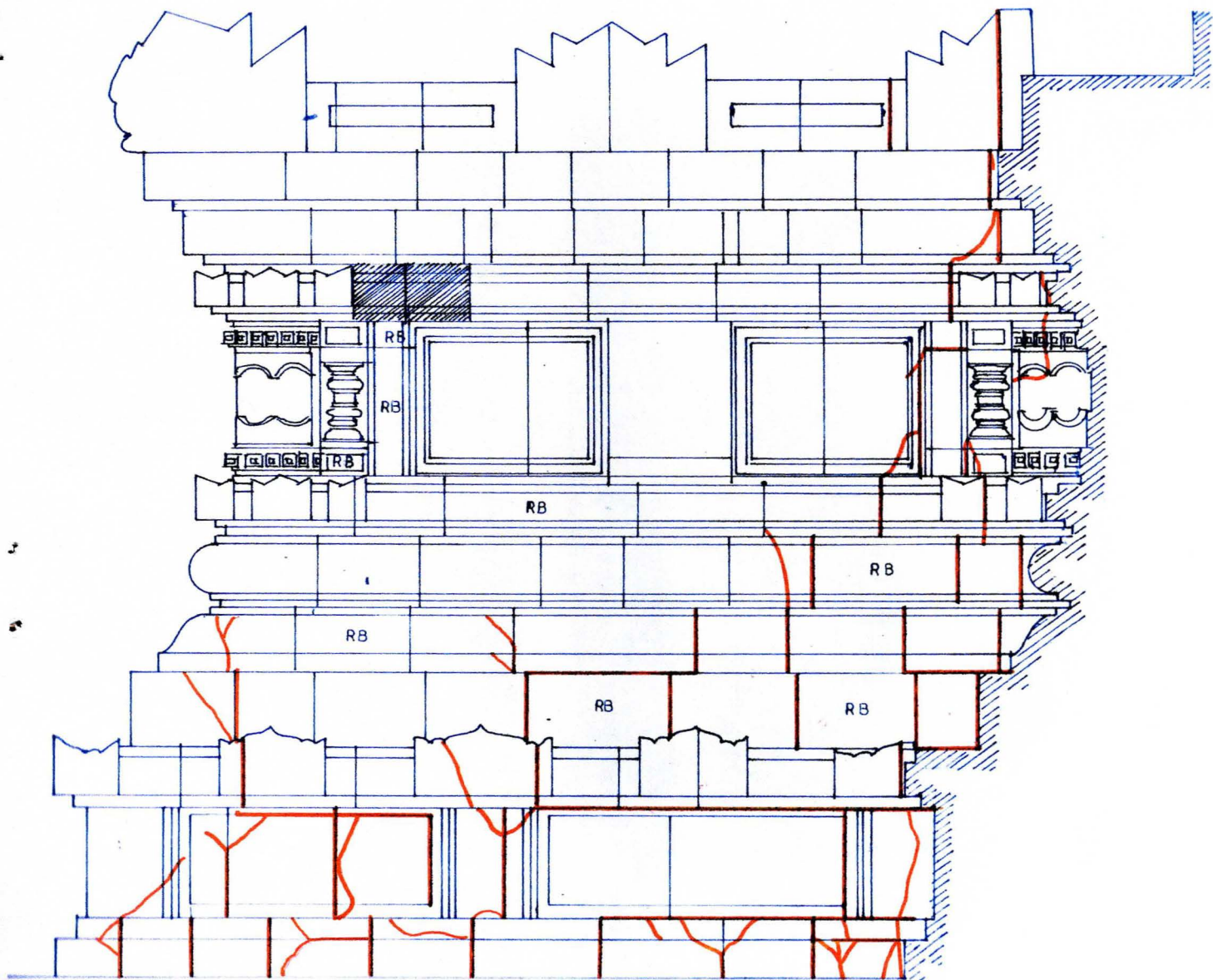

Area 3

Remark

— Cracking and open joint stone

Siwa Temple
Base Part Level II

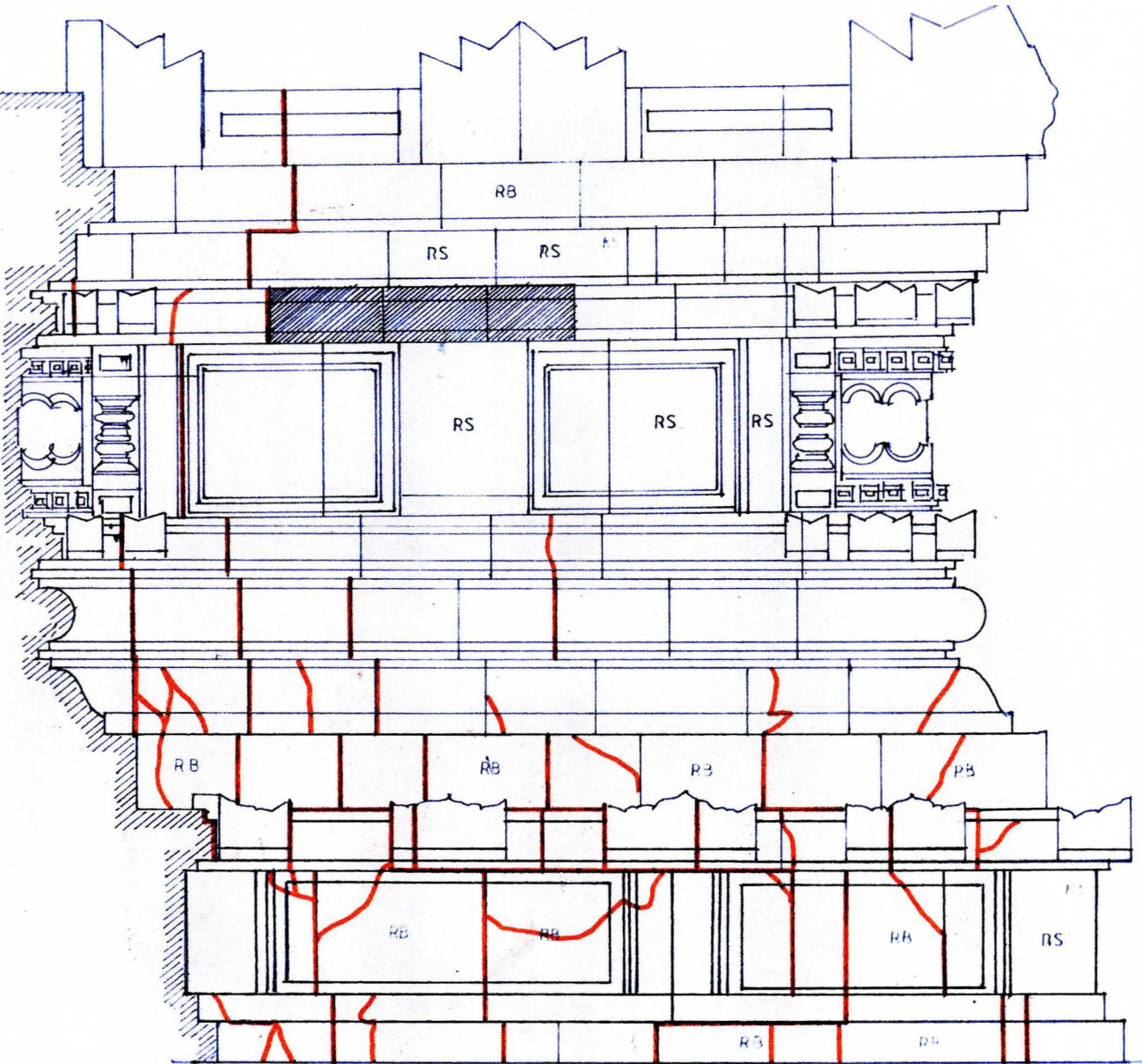

Area 4

Remark

— Cracking and open joint stone

Siwa Temple Base Part Level II

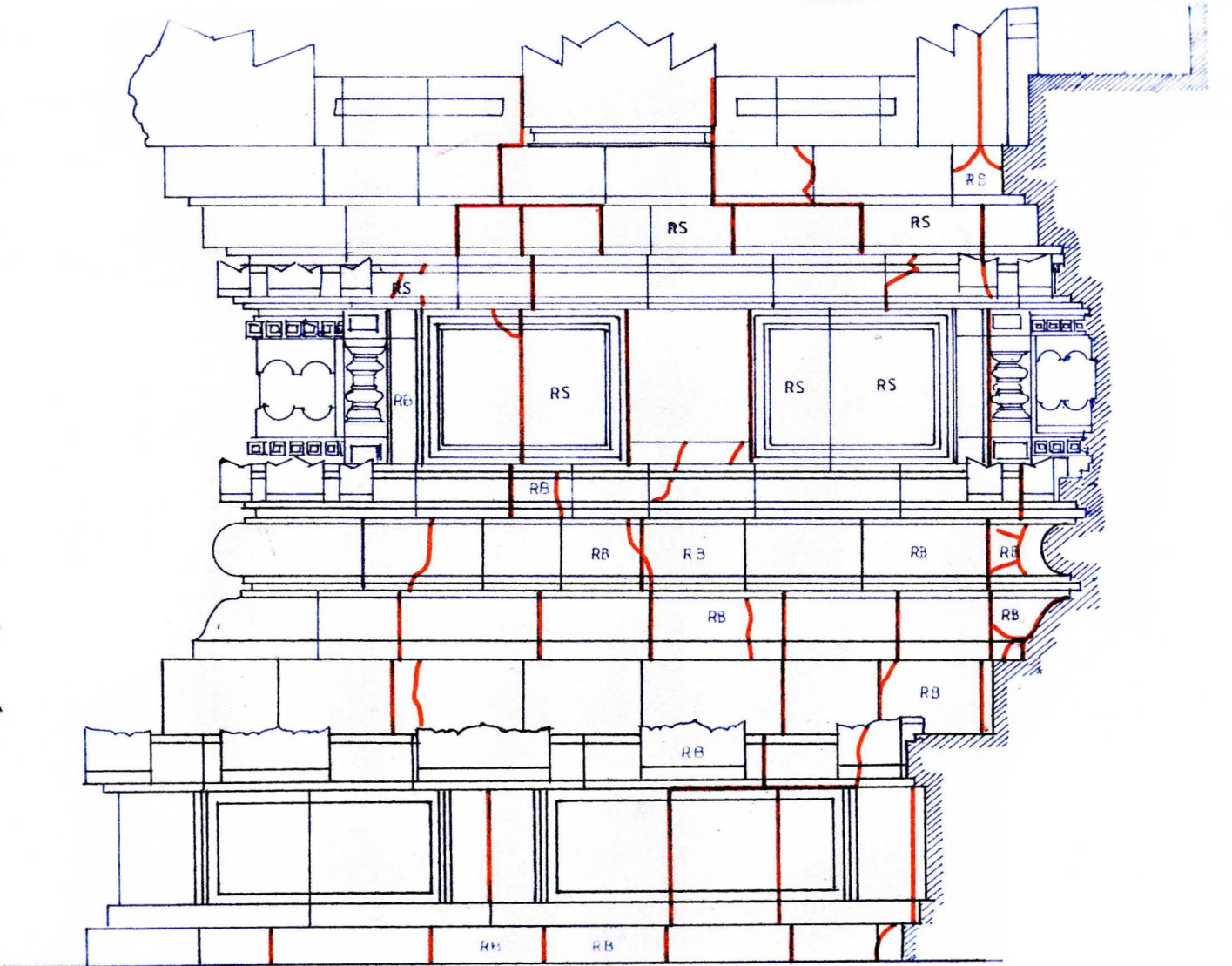

Area 5

Remark

— Cracking and open joint stone

Siwa Temple
Base Part Level II

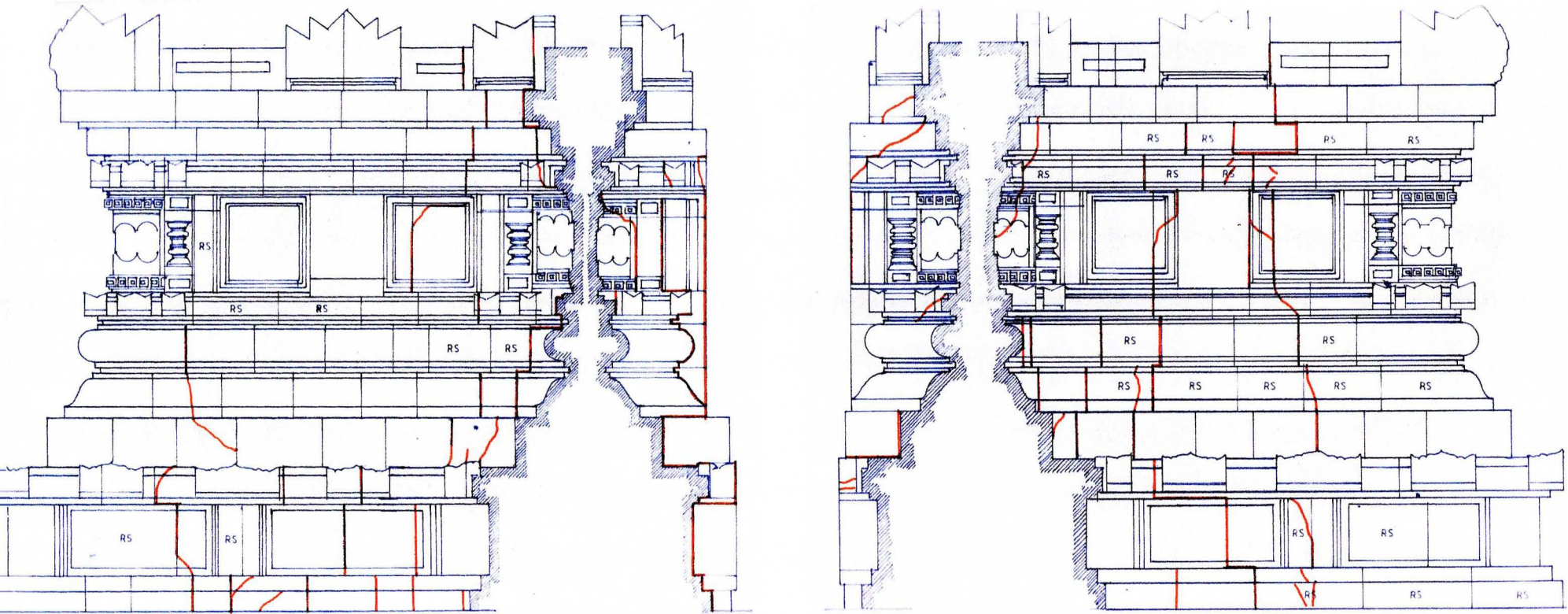

Remark

— Cracking and open joint stone

Area 6

Siwa Temple Base Part Level II

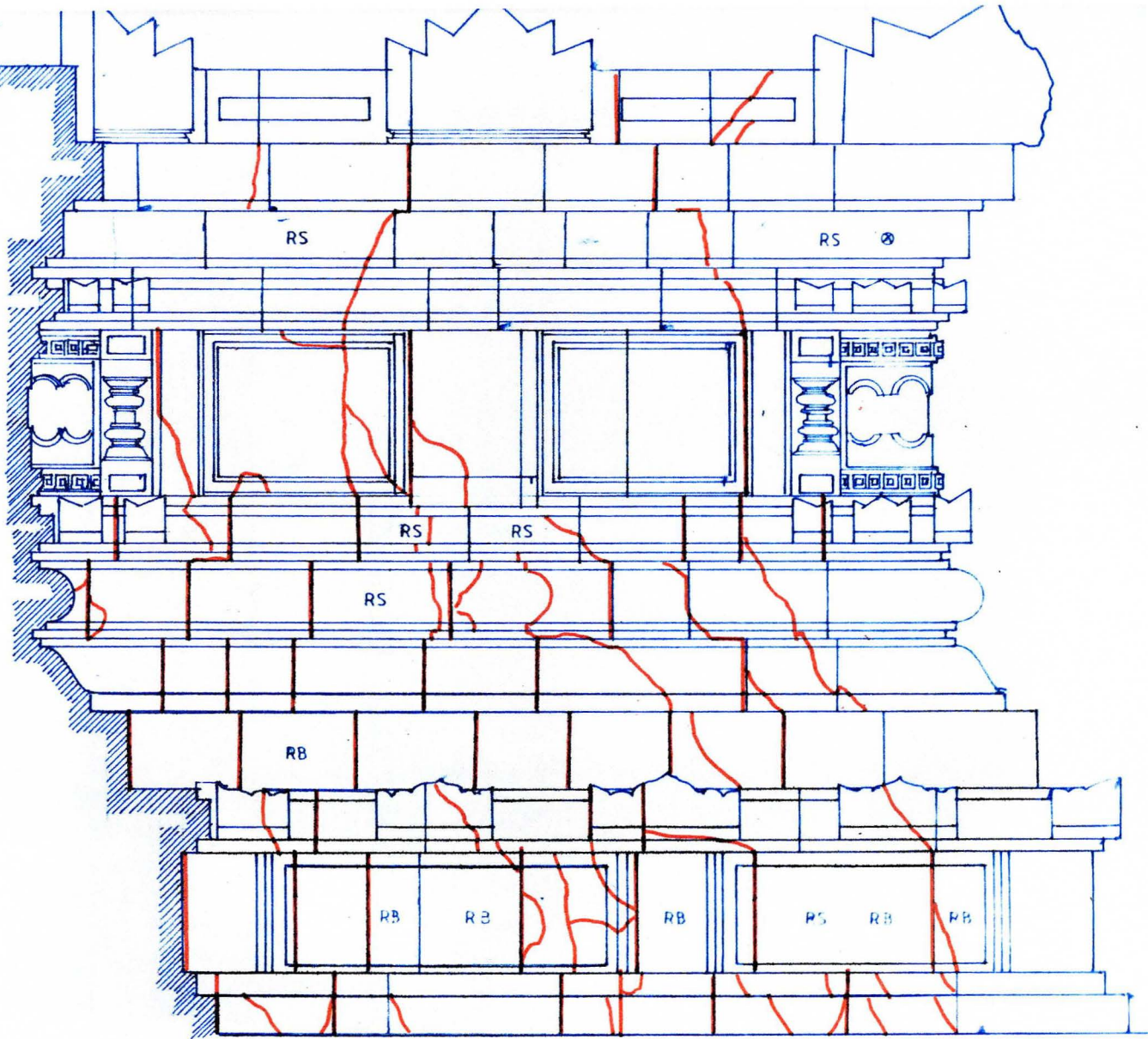

Area 7

Remark

— Cracking and open joint stone

Siwa Temple Base Part Level II

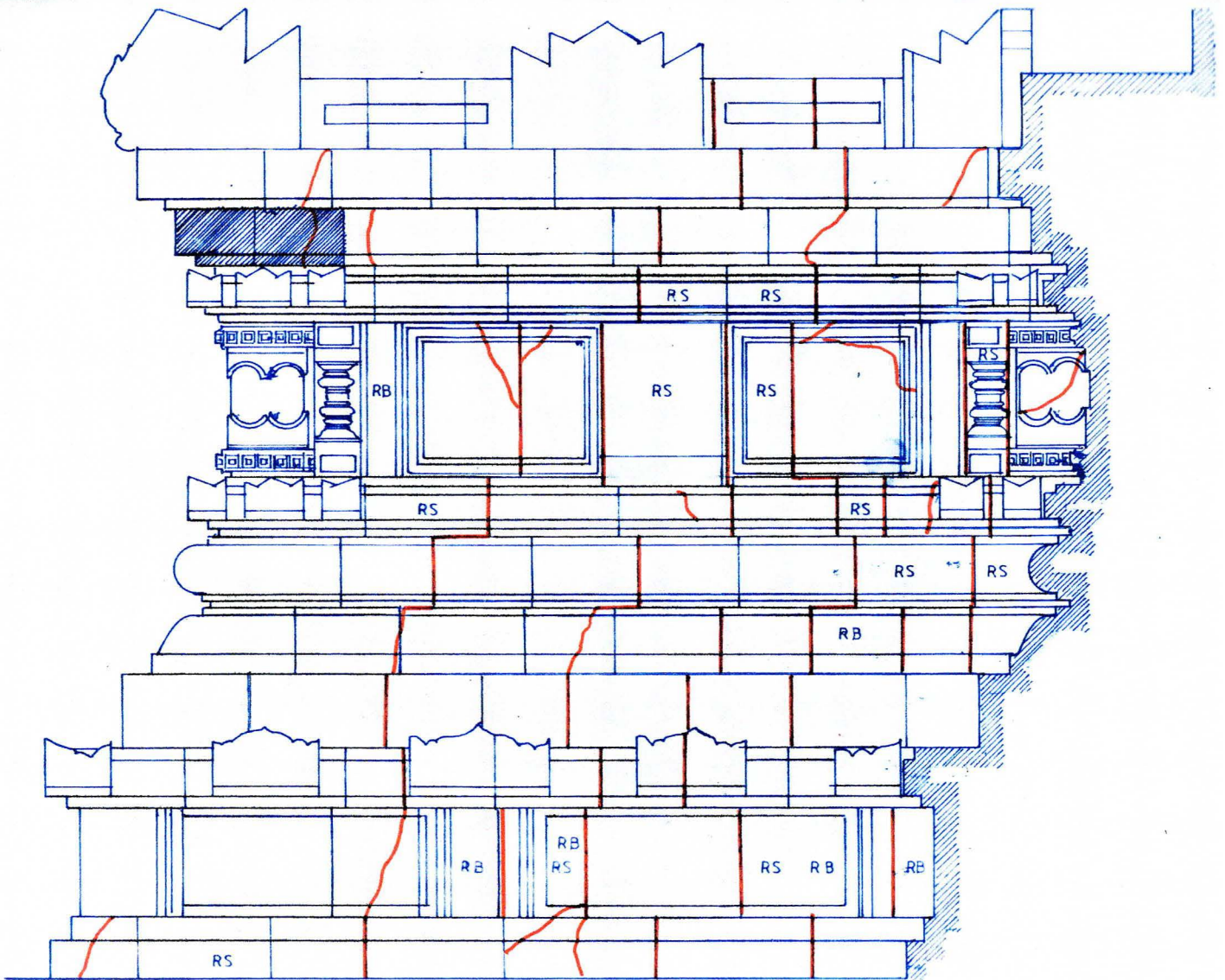

Area 8

Remark

— Craking and open joint stone

Siwa Temple Base Part Level II

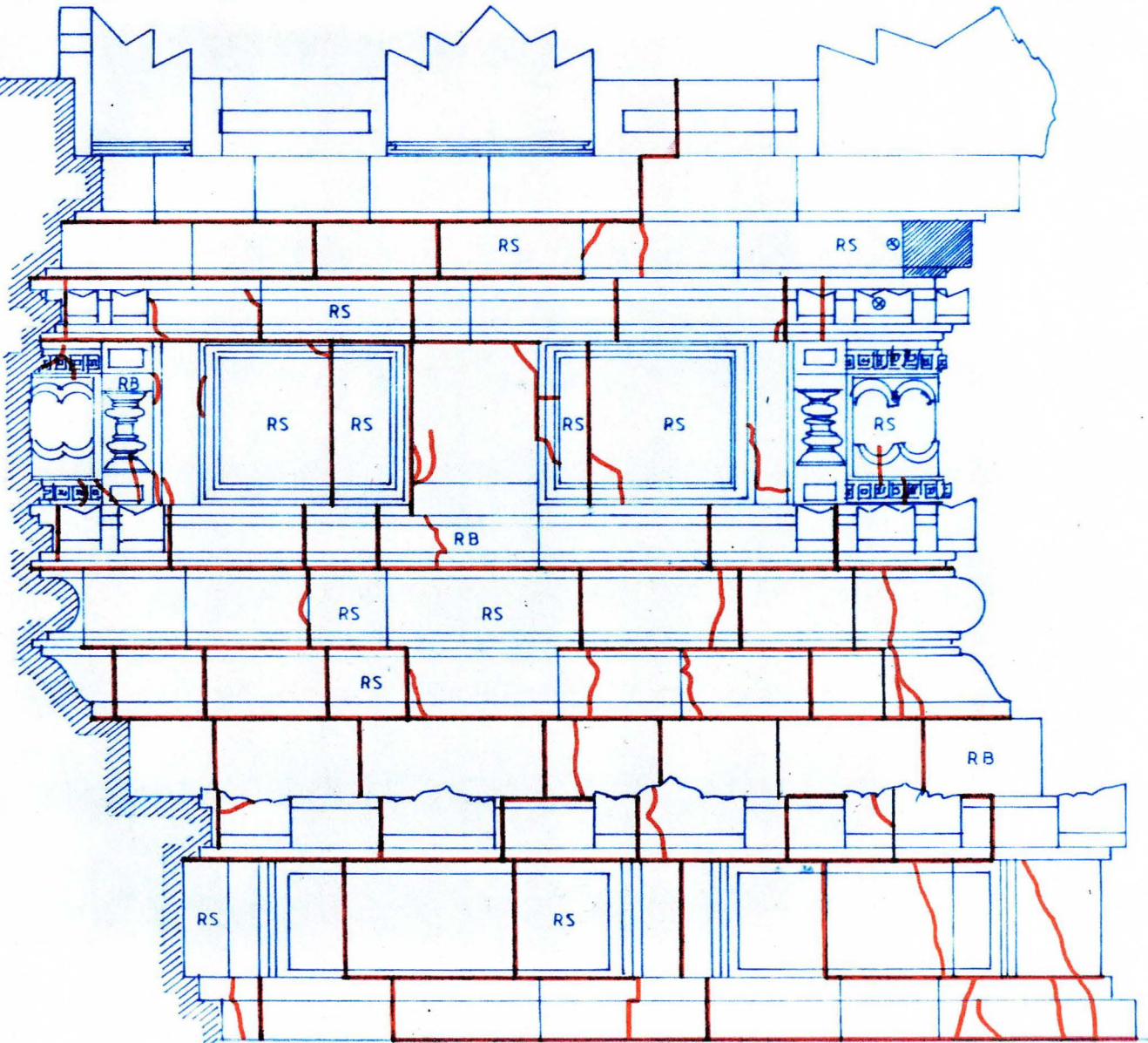

Area 9

Remark

— Cracking and open joint stone

Siwa Temple
Base Part Level II

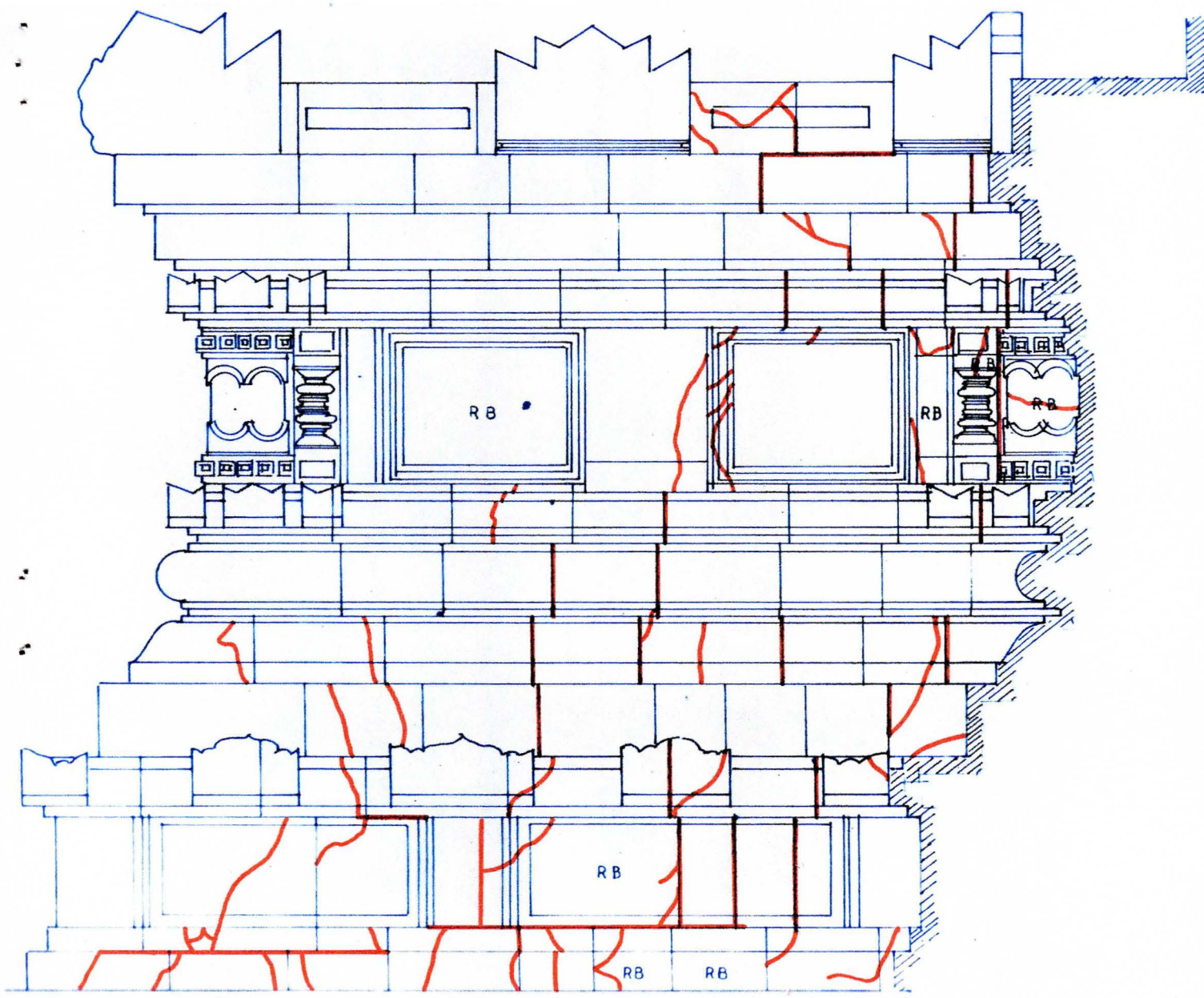

Area 10

Remark

— Cracking and open joint stone

Siwa Temple Base Part Level II

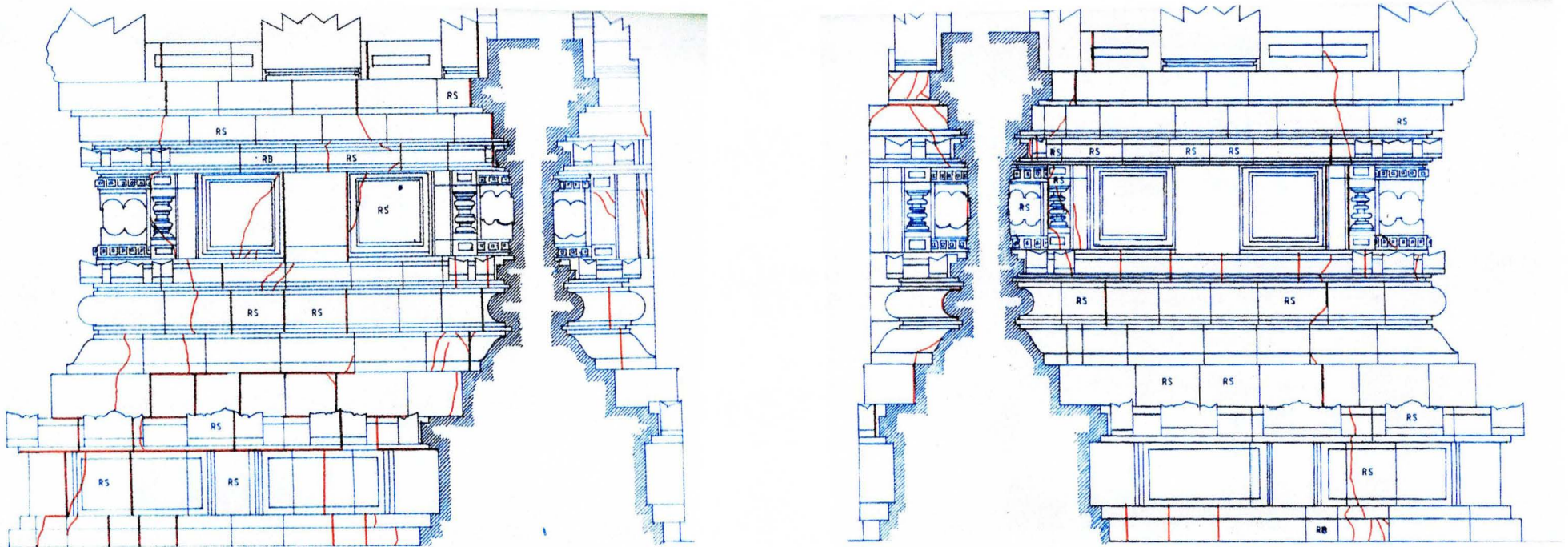

Remark

Area11



Cracking and open joint stone

Siwa Temple
Base Part Leve II

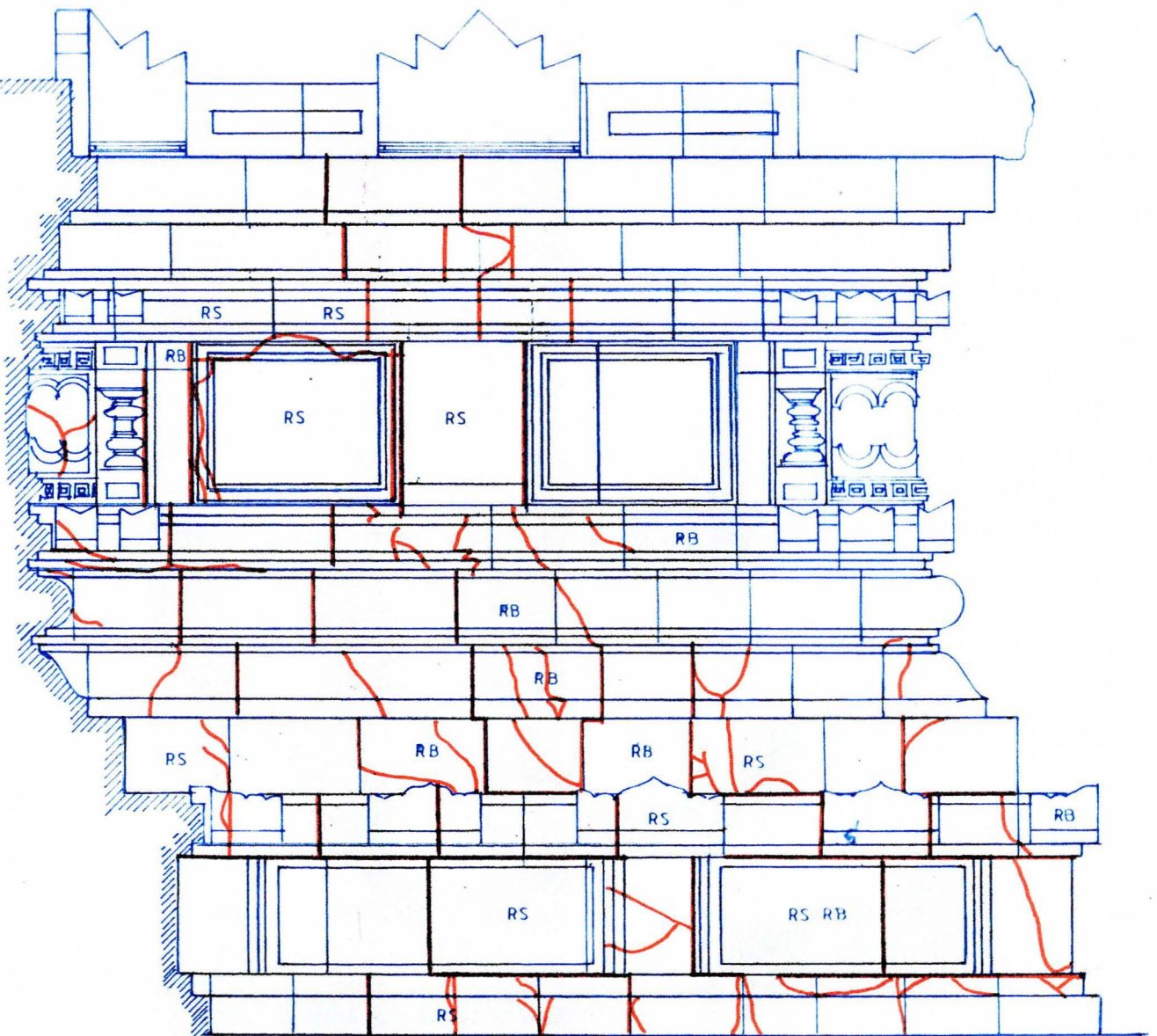

Area 12

Remark

— Cracking and open joint stone

Siwa Temple
Base Part Level II

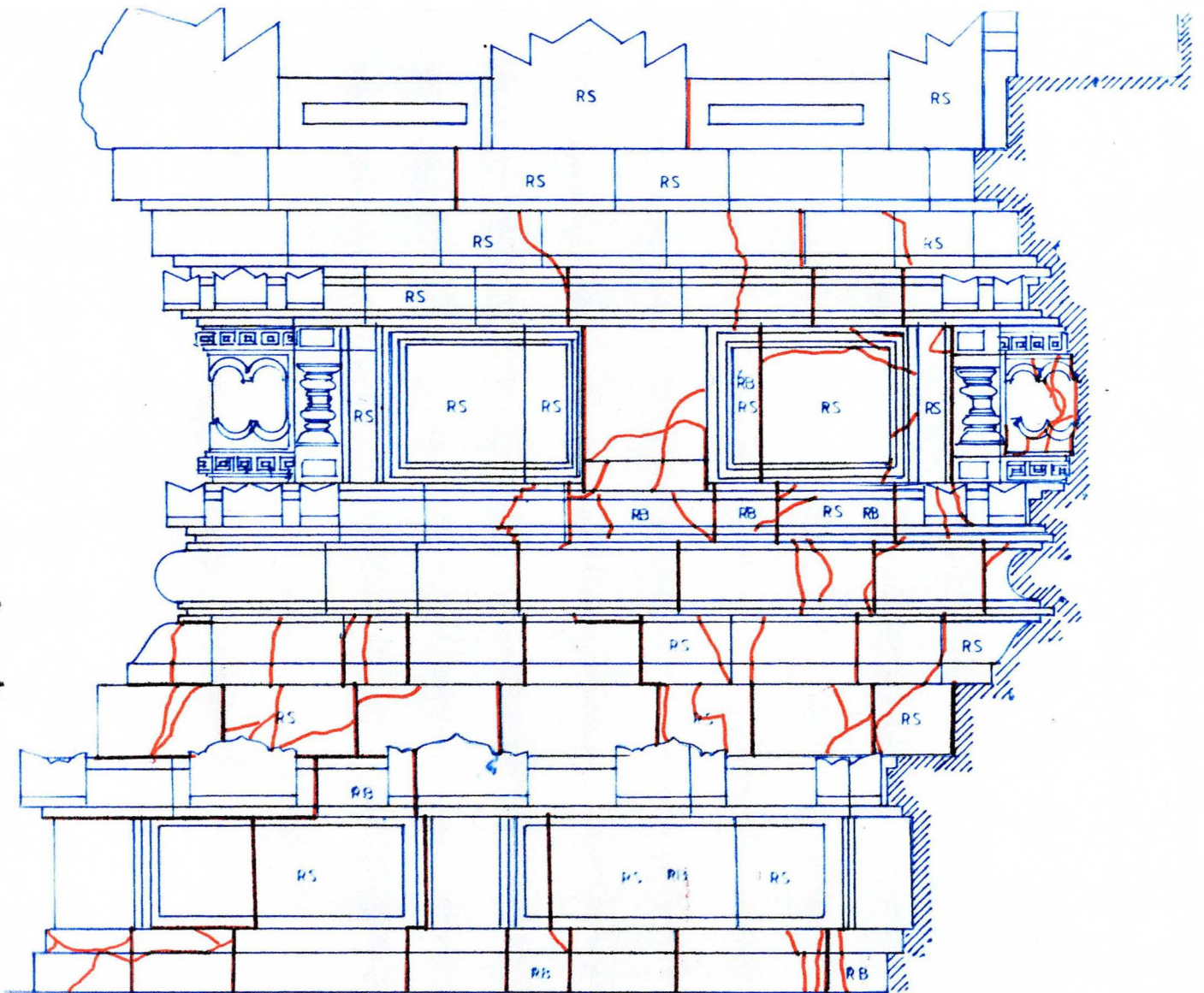

Area 13

Remark

— Cracking and open joint stone

Siwa Temple Base Part Level II

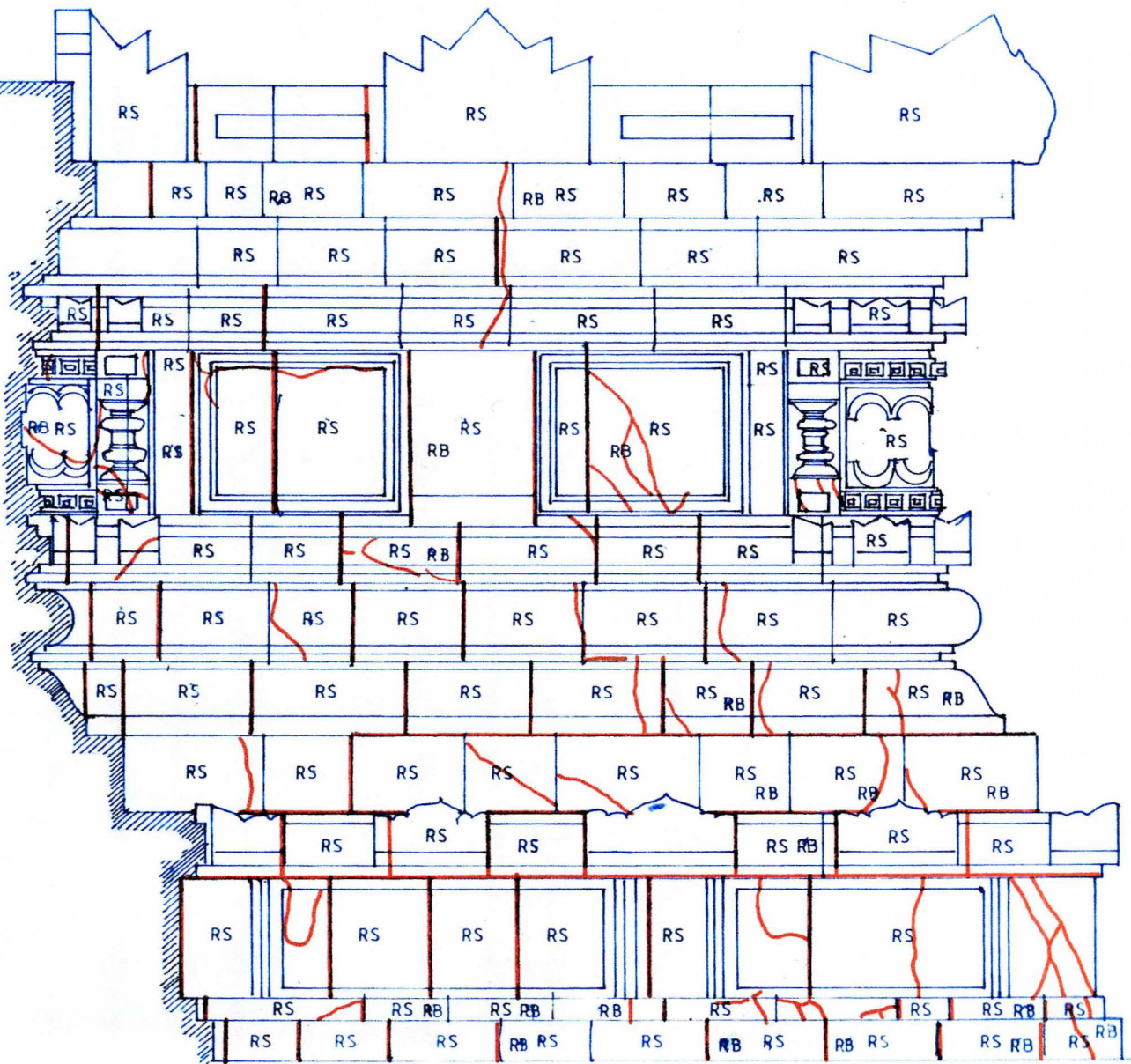

Area 14

Remark

— Cracking and open joint stone

Siwa Temple Base Part Level II

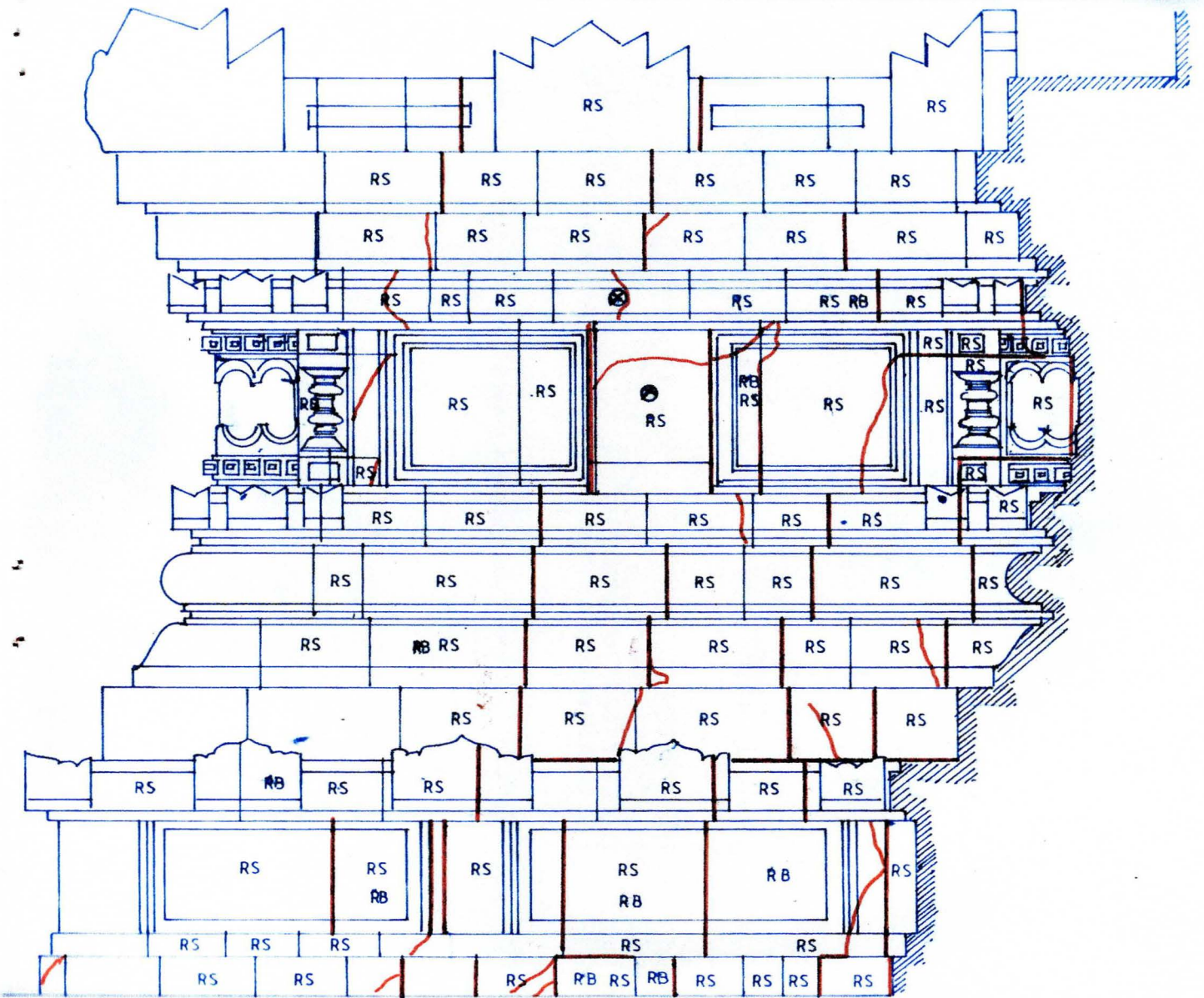

Area 15

Remark

— Craking and open joint

Siwa Temple Base Part Level II

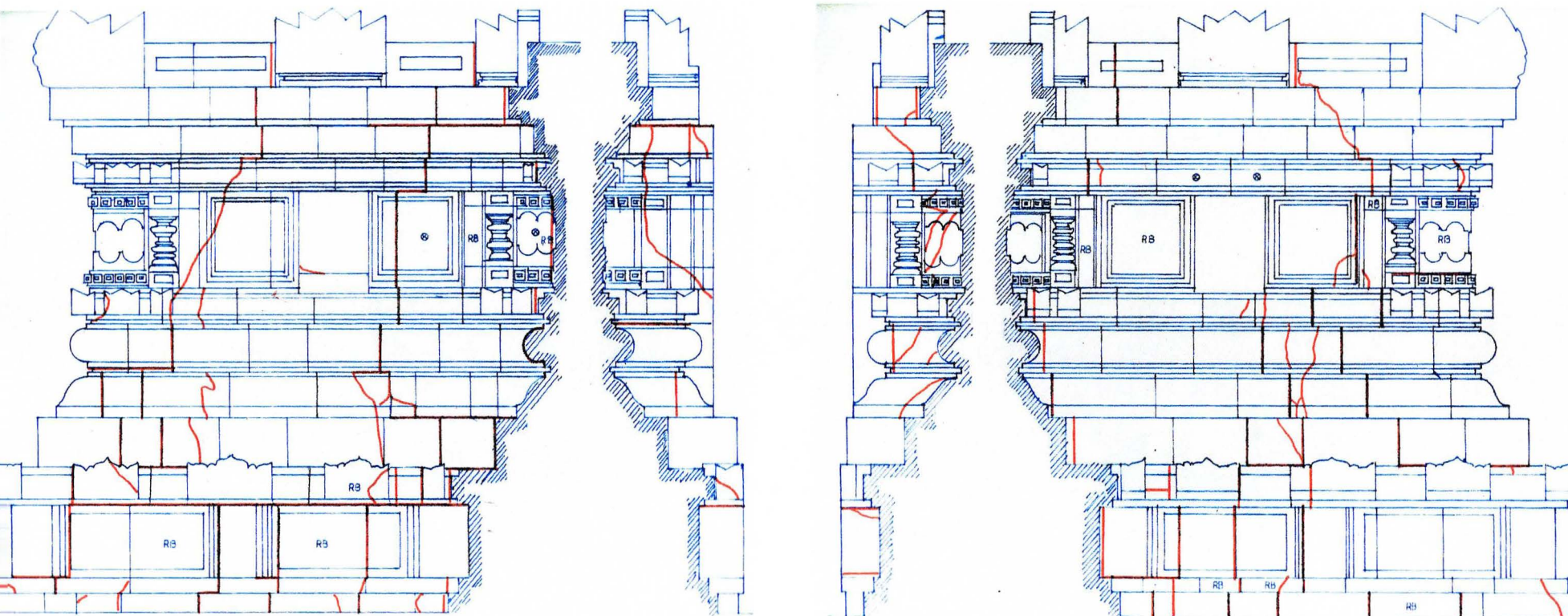

Remark

— Cracking and open joint stone

Area XVI

Siwa Temple
Base Part Level II

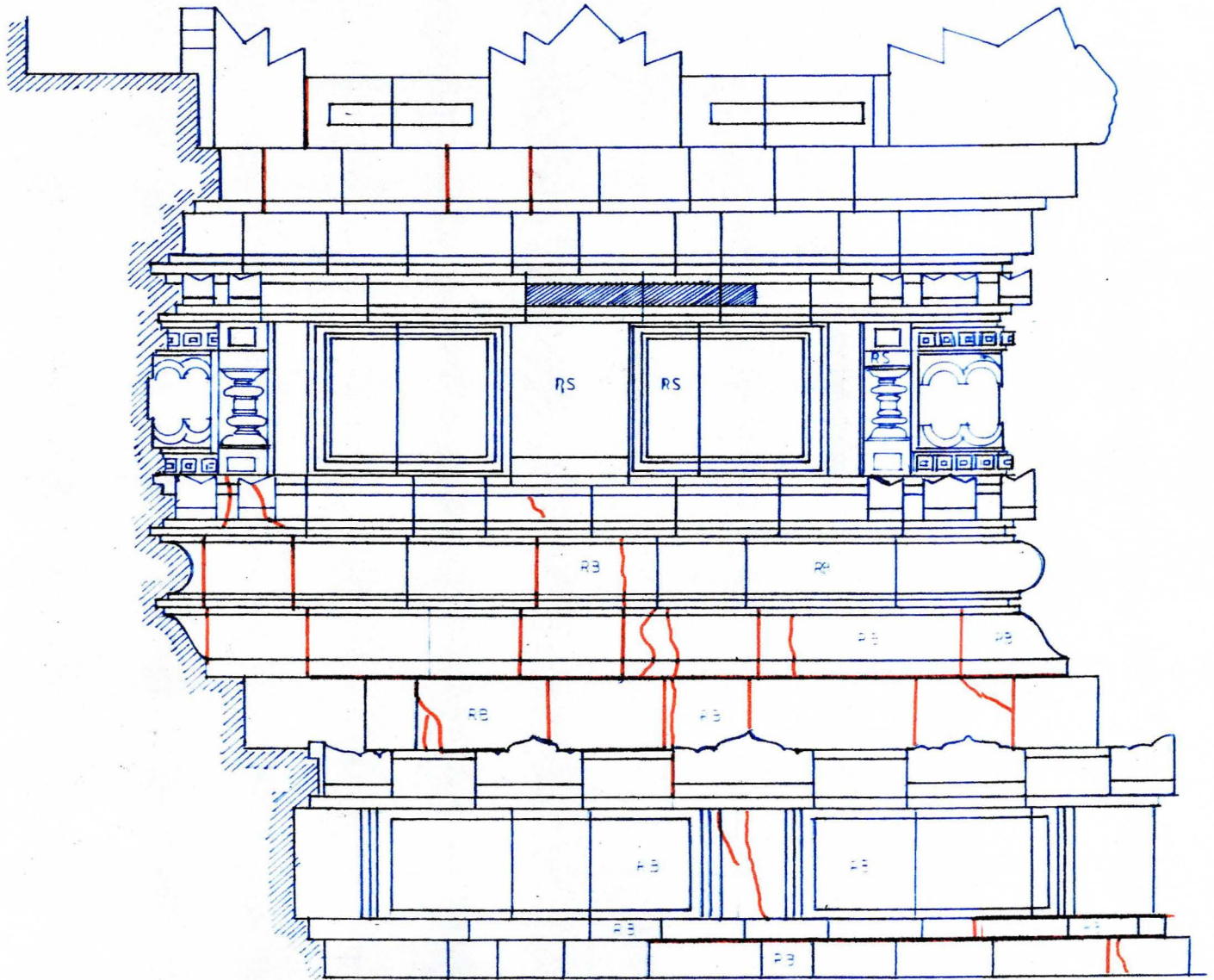

Area 17

Remark

— Craking and open joint stone

Siwa Temple
Base part Level II

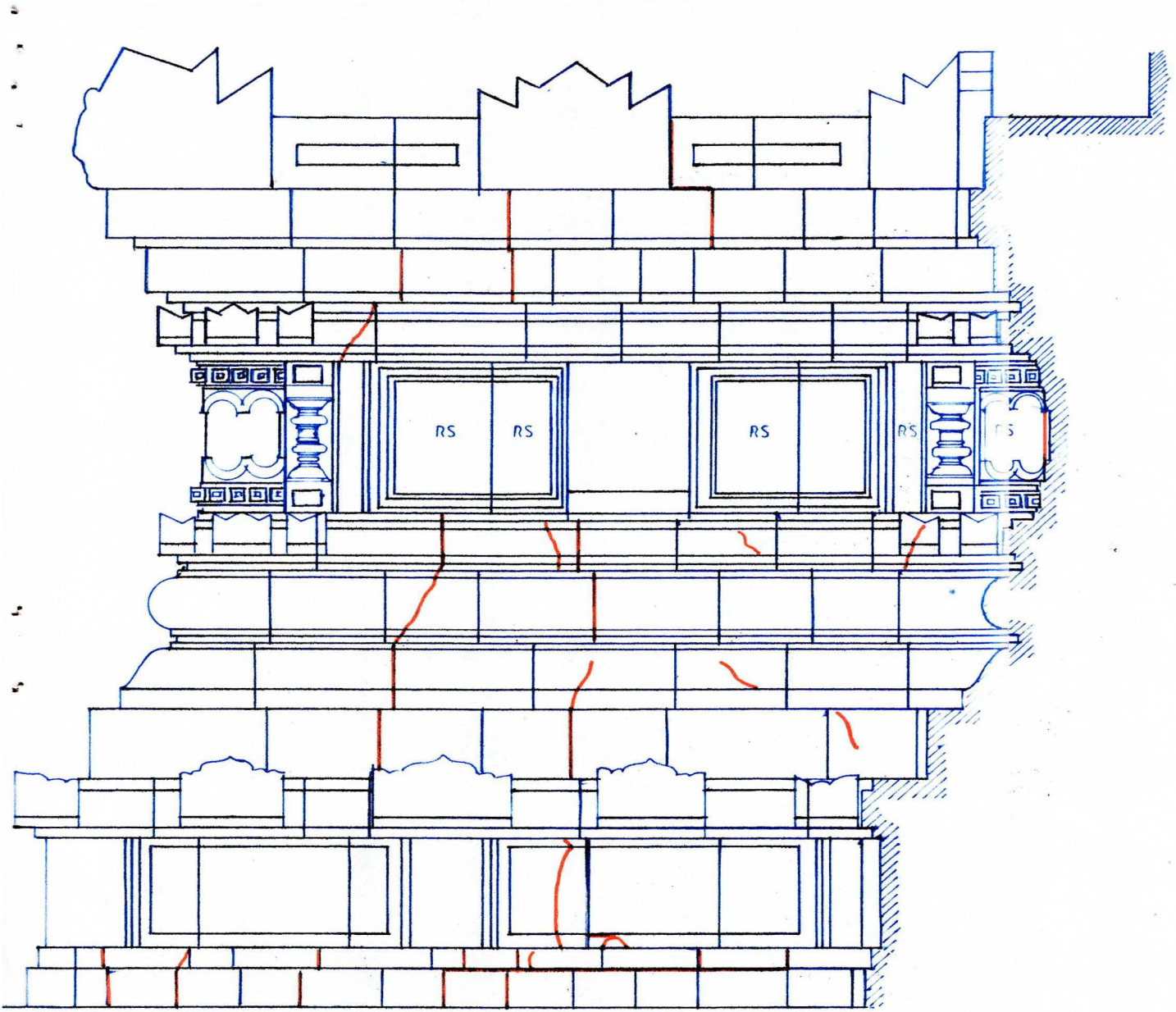

Area18

Remark

— Craking and open joint stone

Siwa Temple
Base Part Level II

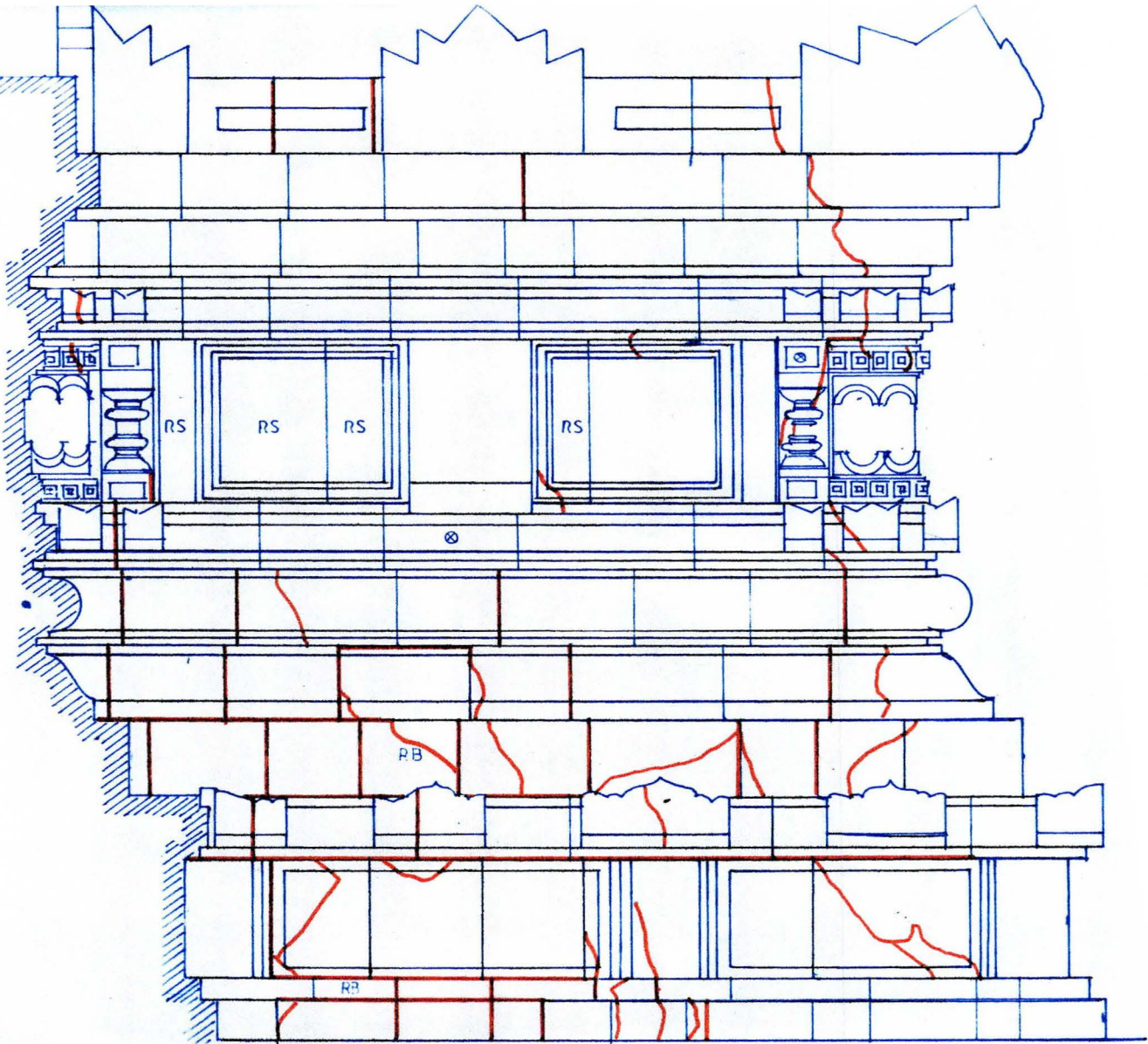

Area 19

Remark

— Craking and open joint stone

Siwa Temple
Base Part Level II

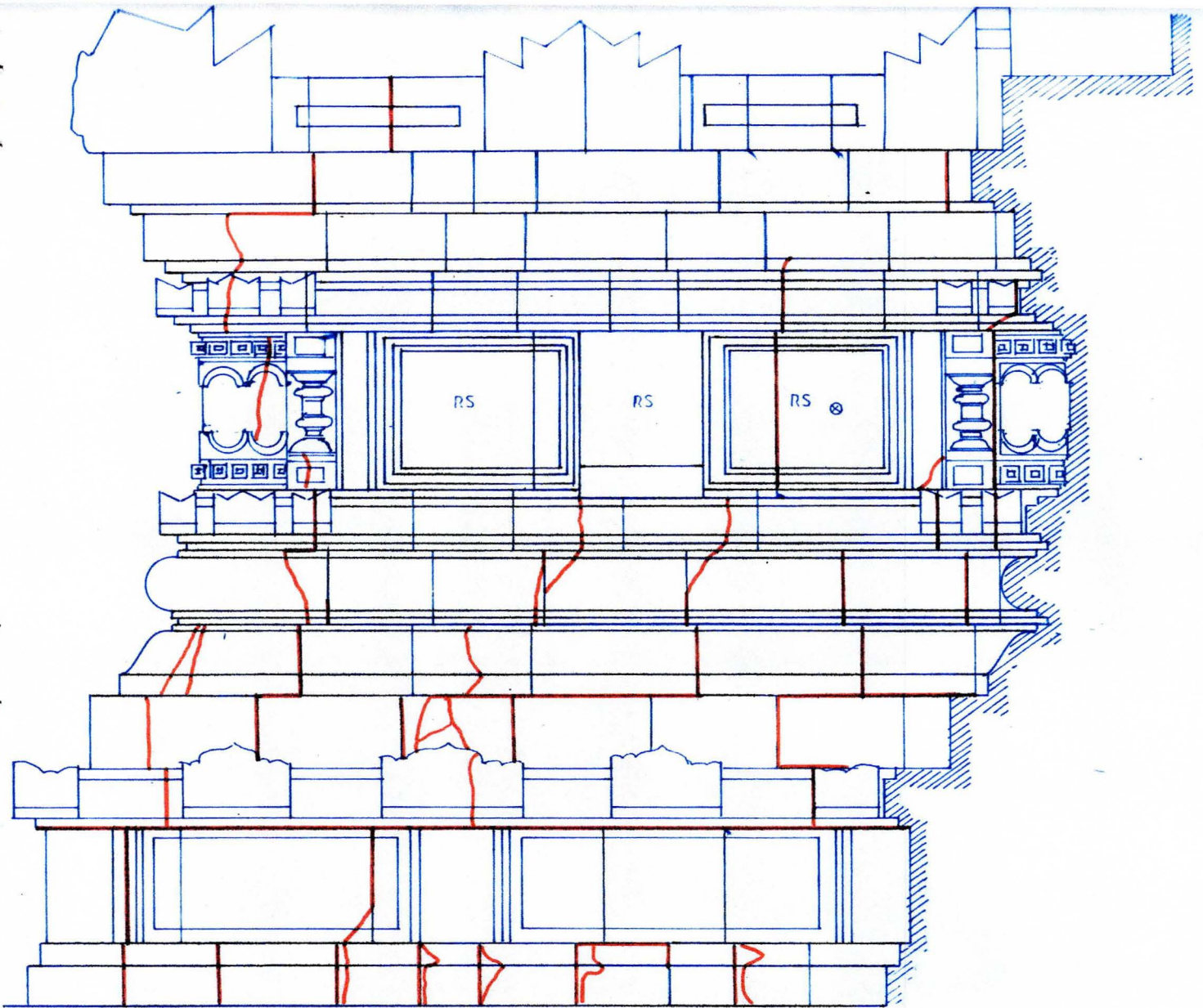

Area 20

Remark

— Cracking and open joint stone

Siwa Temple The Body Part I

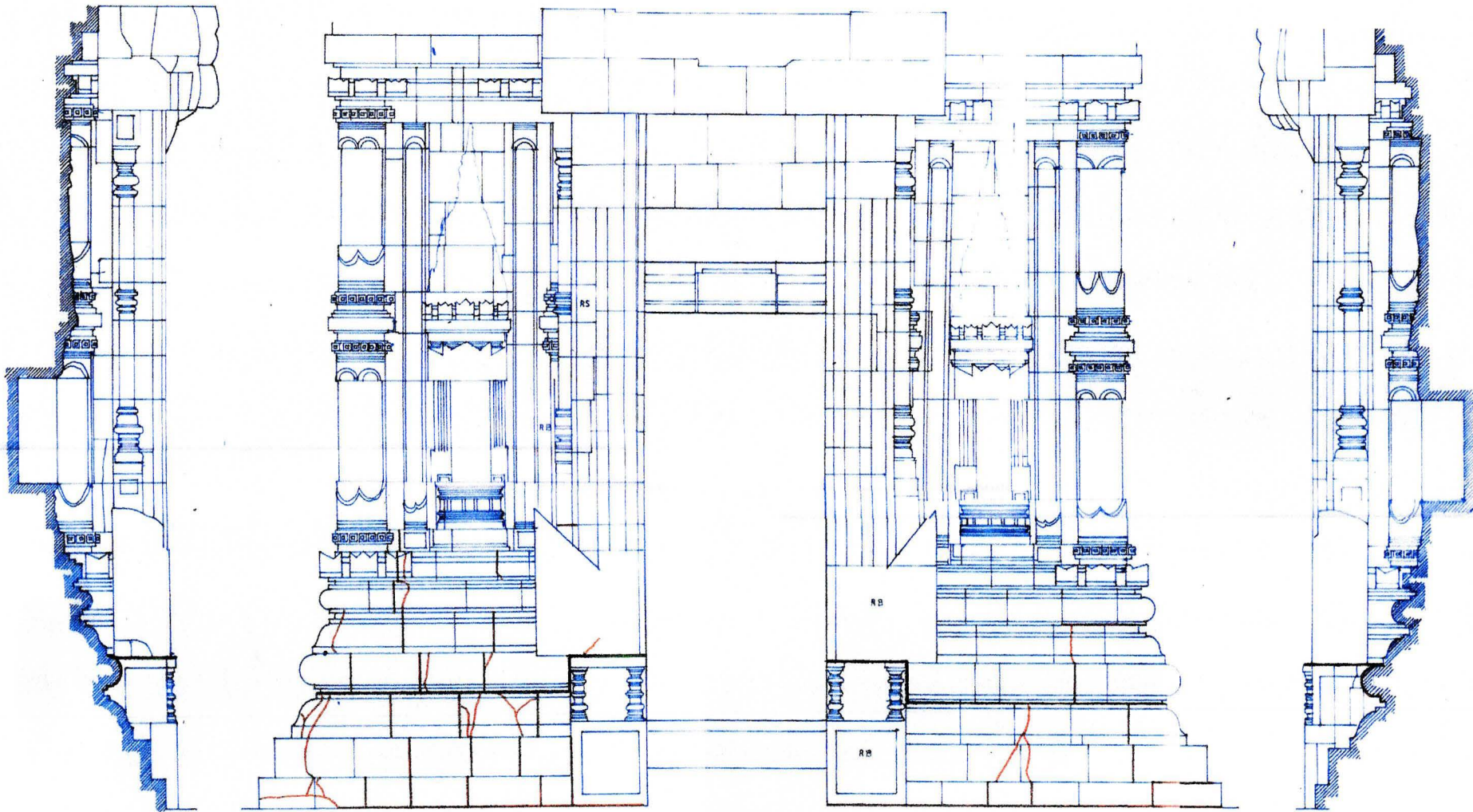

Remark



Cracking and open joint stone

Area I

Siwa Temple The Body Part I

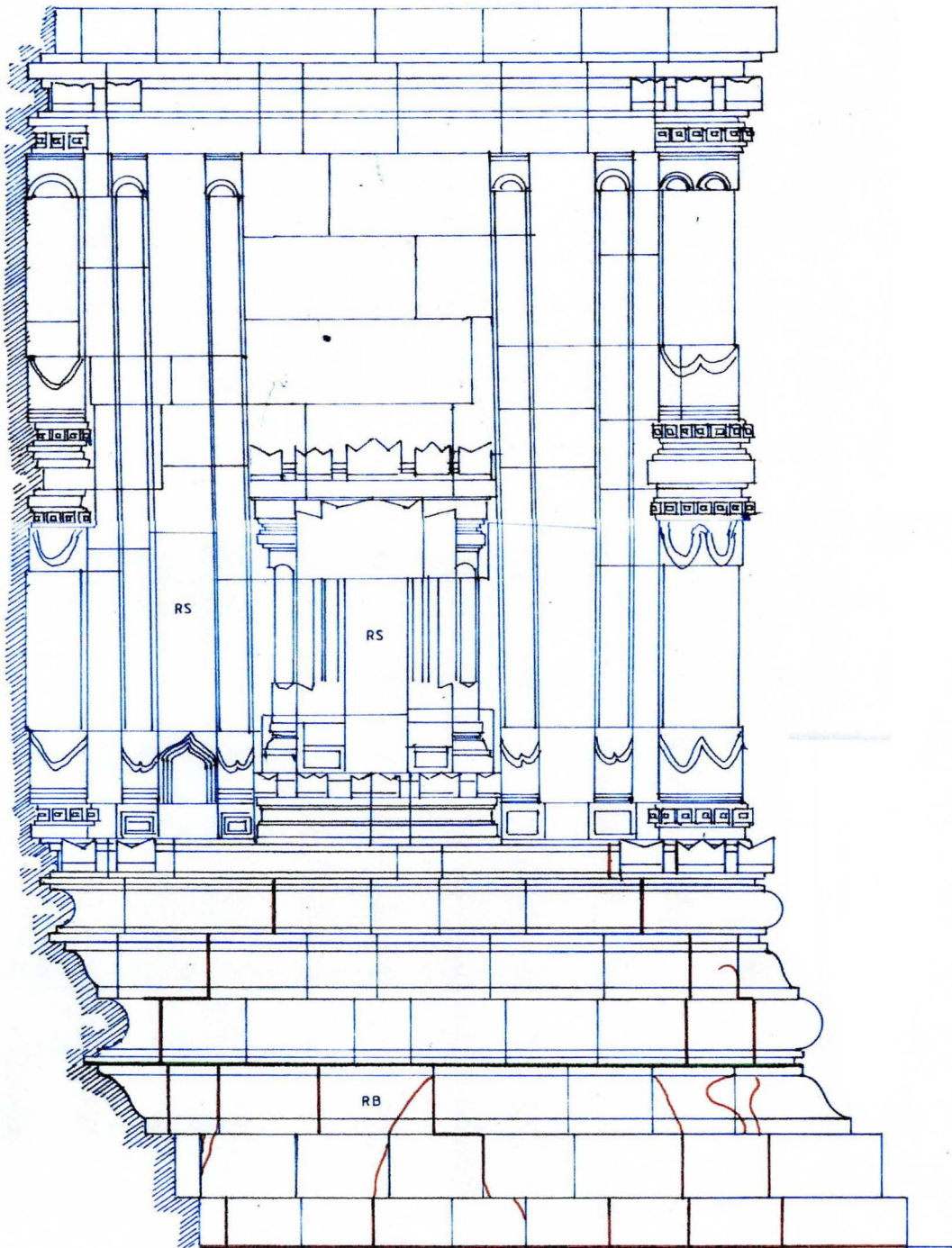

BIDANG II

Area II

Remark

— Cracking and open joint stone

Siwa Temple The Body Part I

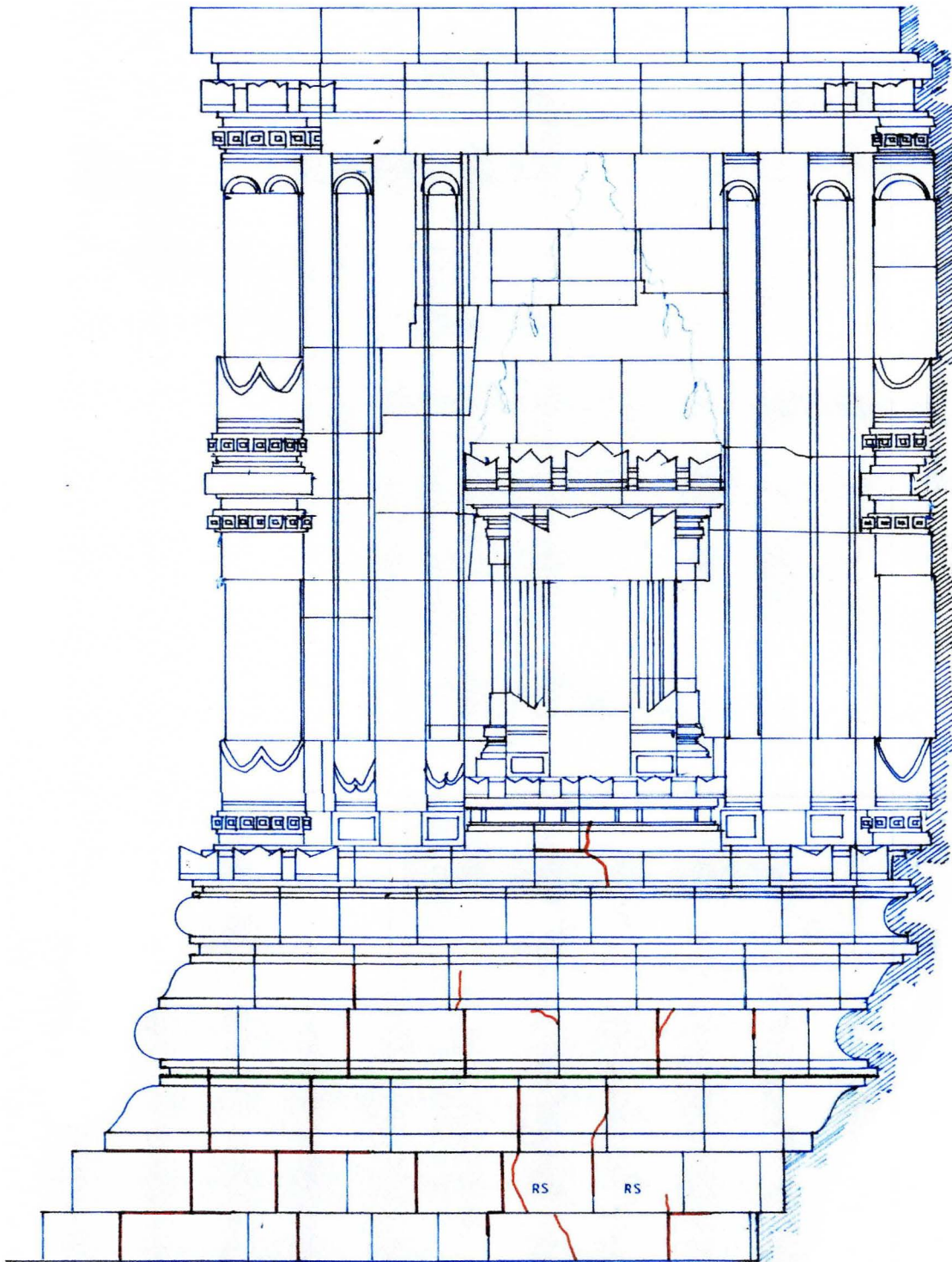

Area III

Remark

— Craking and open joint stone

Siwa Temple The Body Part I

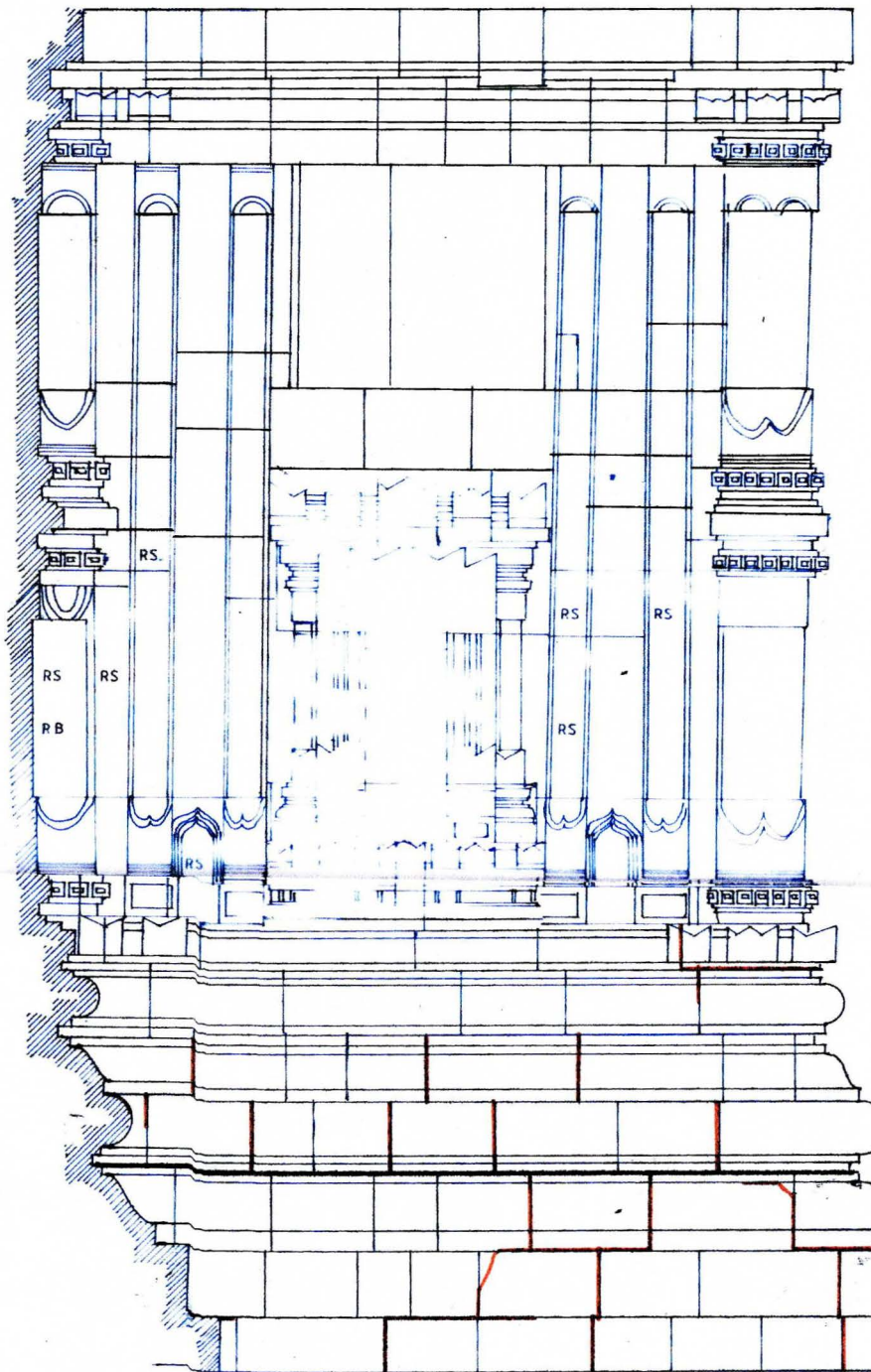

Area IV

Remark



Craking and open joint stone

Siwa Temple The Body Part I

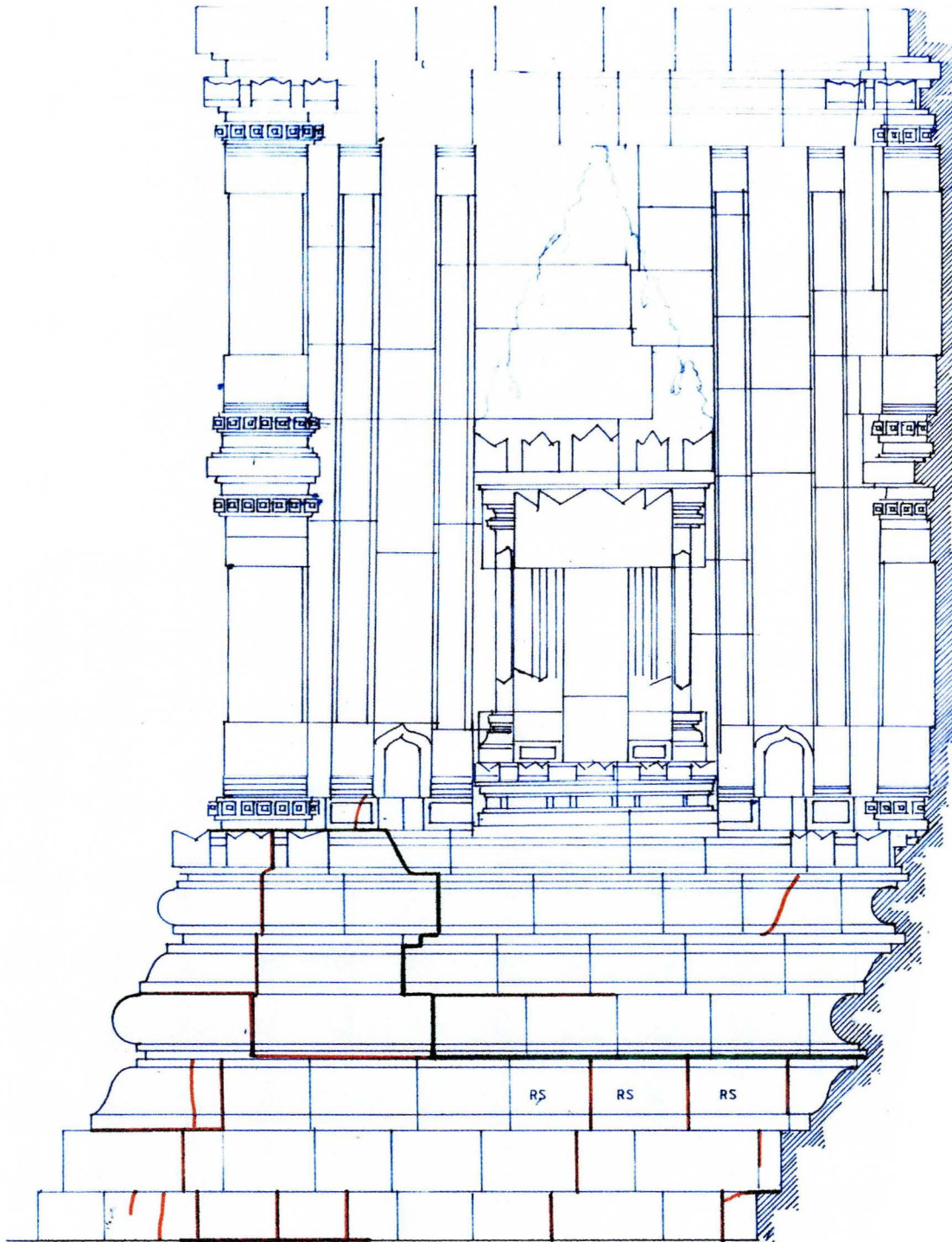

Area V

Remark

— Cracking and open joint stone

Siwa Temple The Body Part I

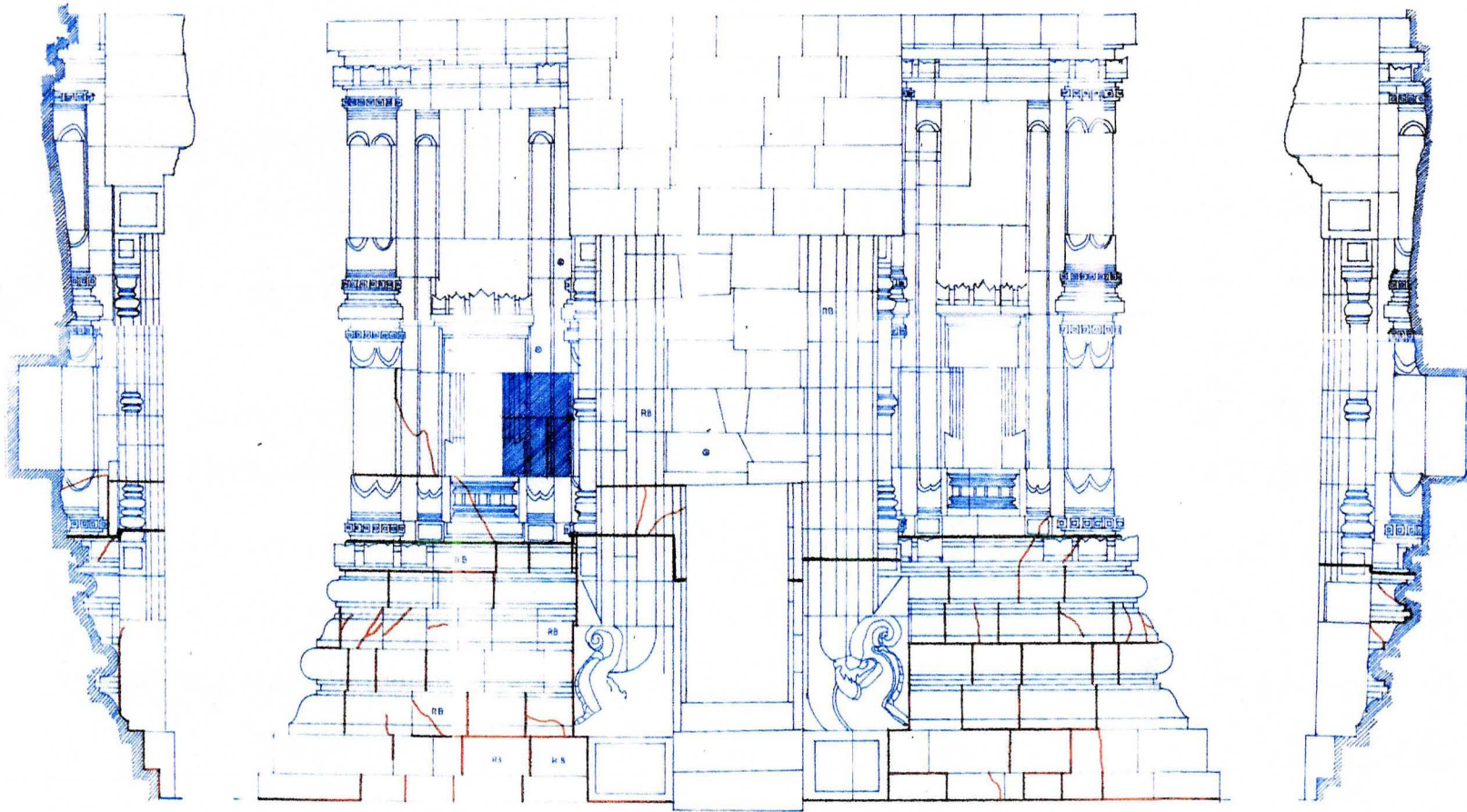

Remark

— Cracking and open joint stone

Area VI

Siwa Temple The Body Part I

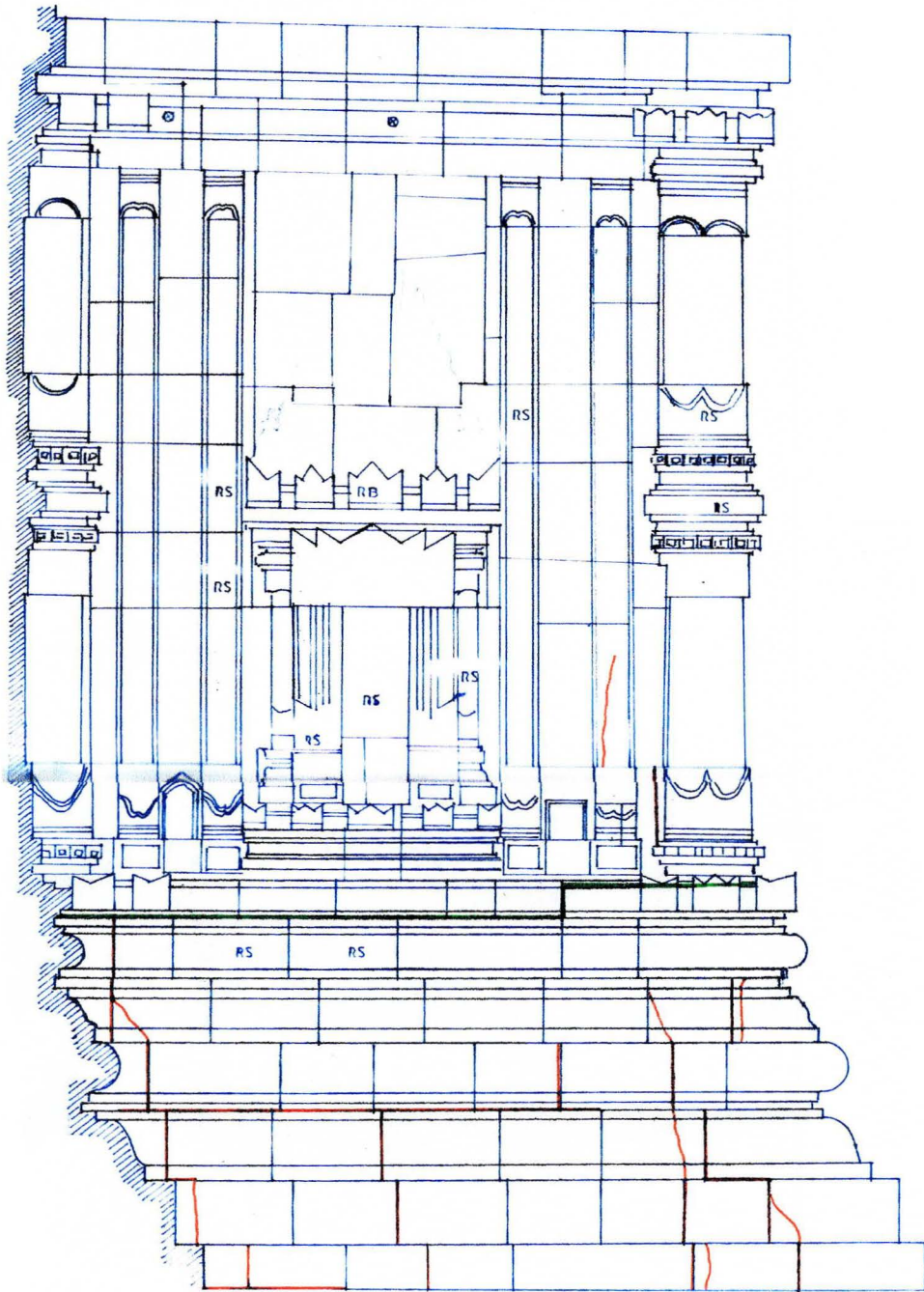

Area VII

Remark



Cracking and open joint stone

Siwa Temple The Body Part I

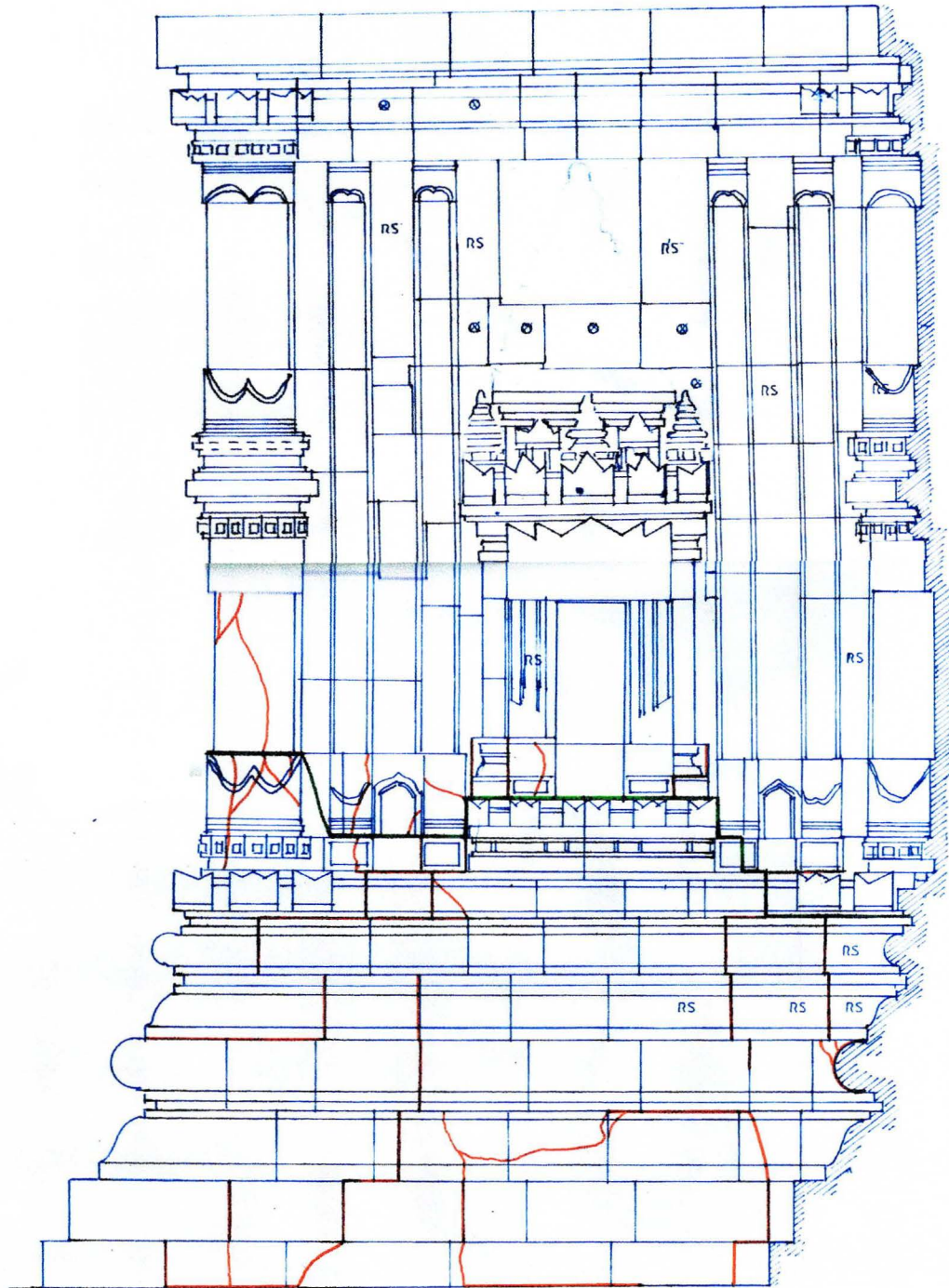

BIDANG VIII

Area VIII

Remark

— Cracking and open joint stone

Siwa Temple The Body Part I

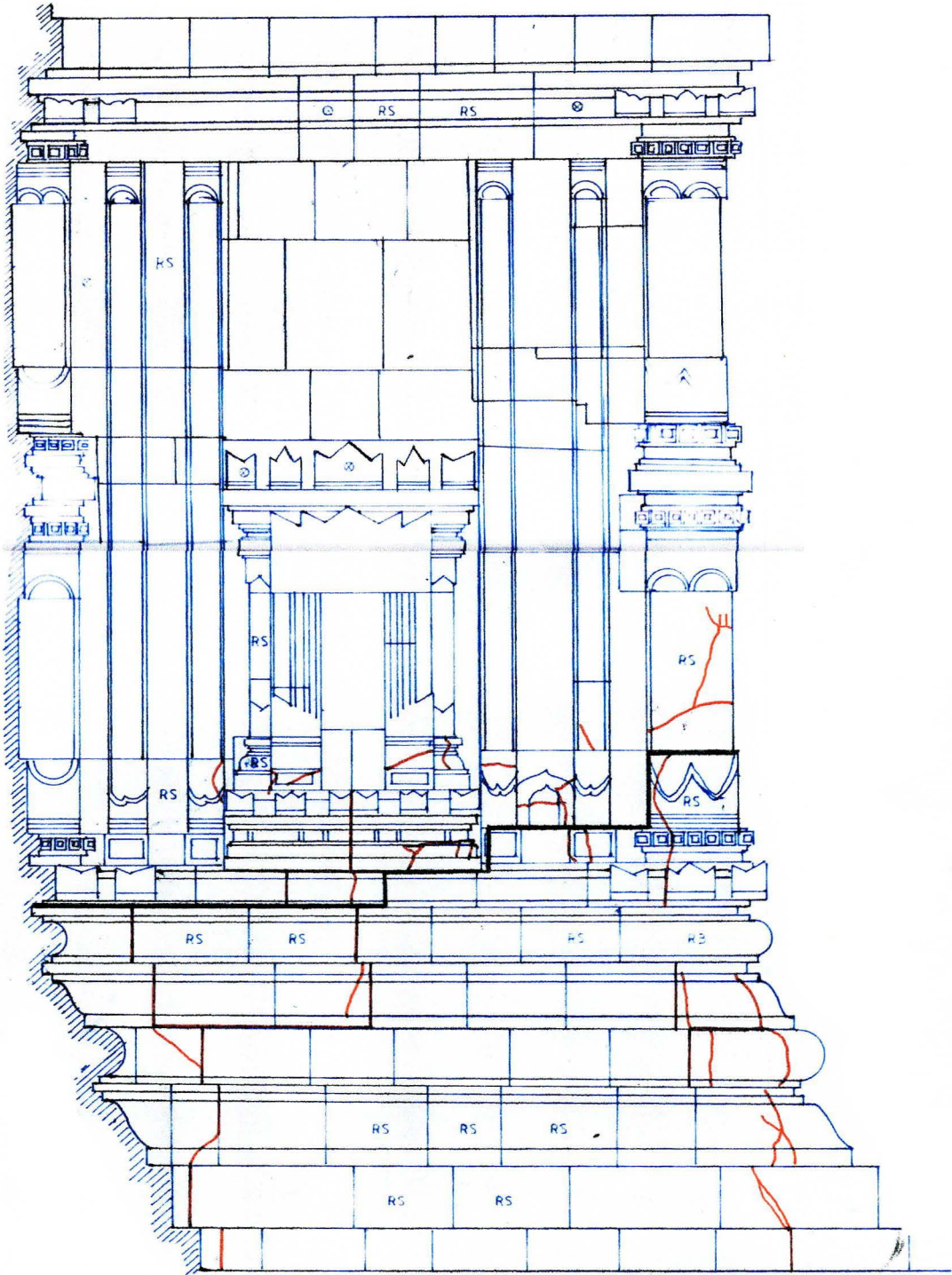

Area 9

Remark

— Craking and open joint stone

Siwa Temple The Body Part I

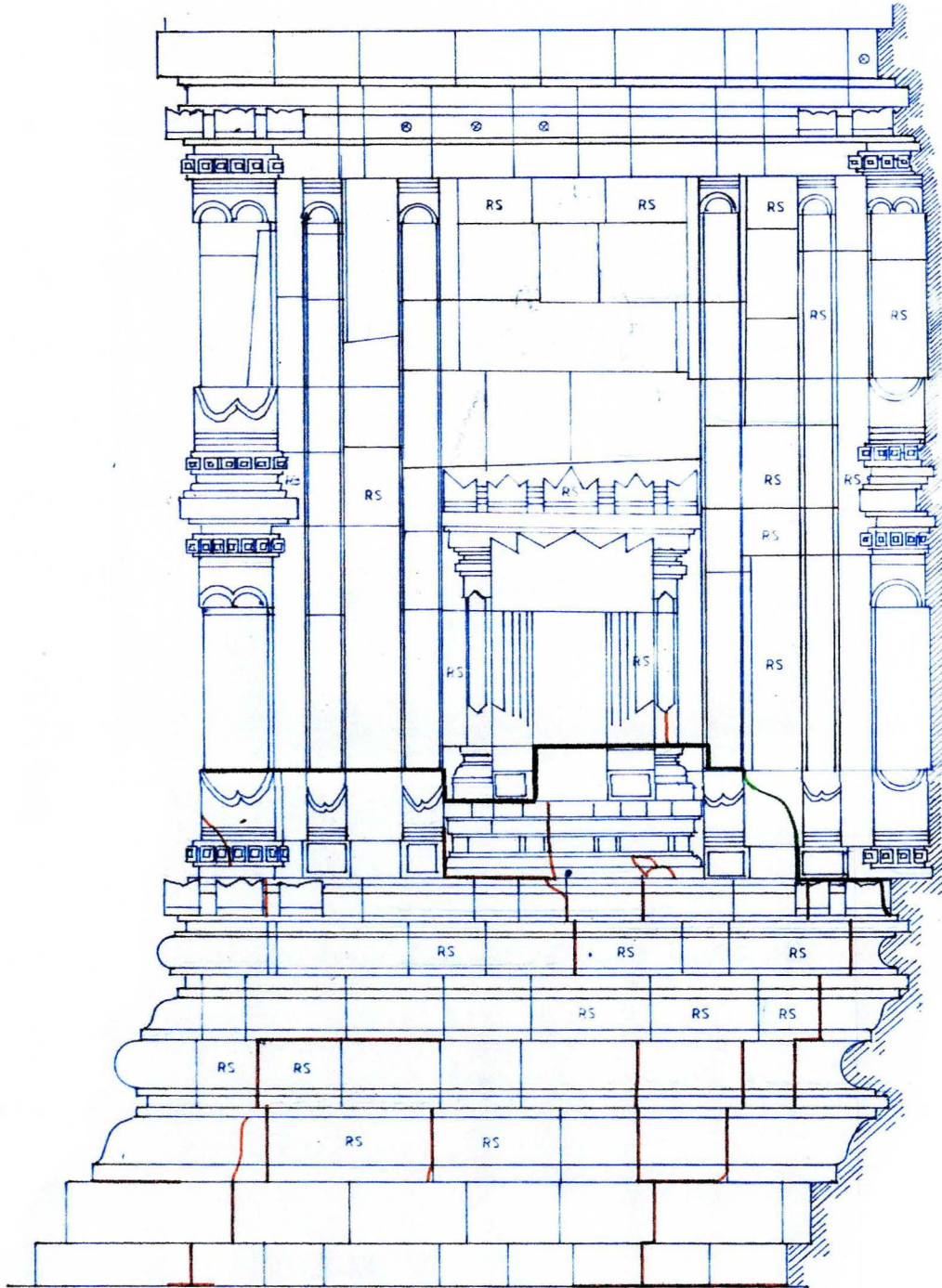

Remark

Area X

Craking and open joint stone

Siwa Temple The Body Part I

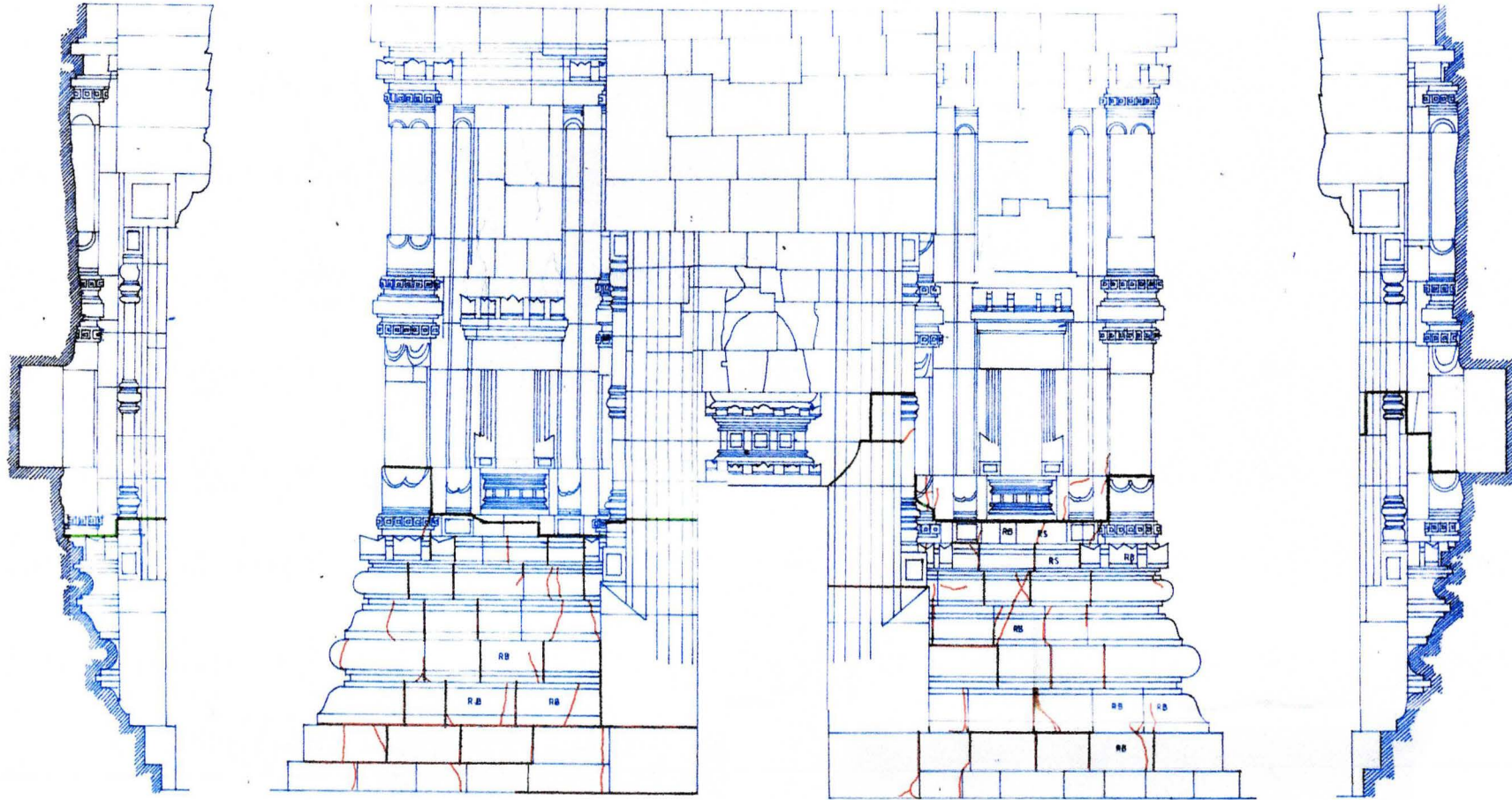

Remark



Cracking and open joint stone

Area XI

Siwa Temple

The body Part I

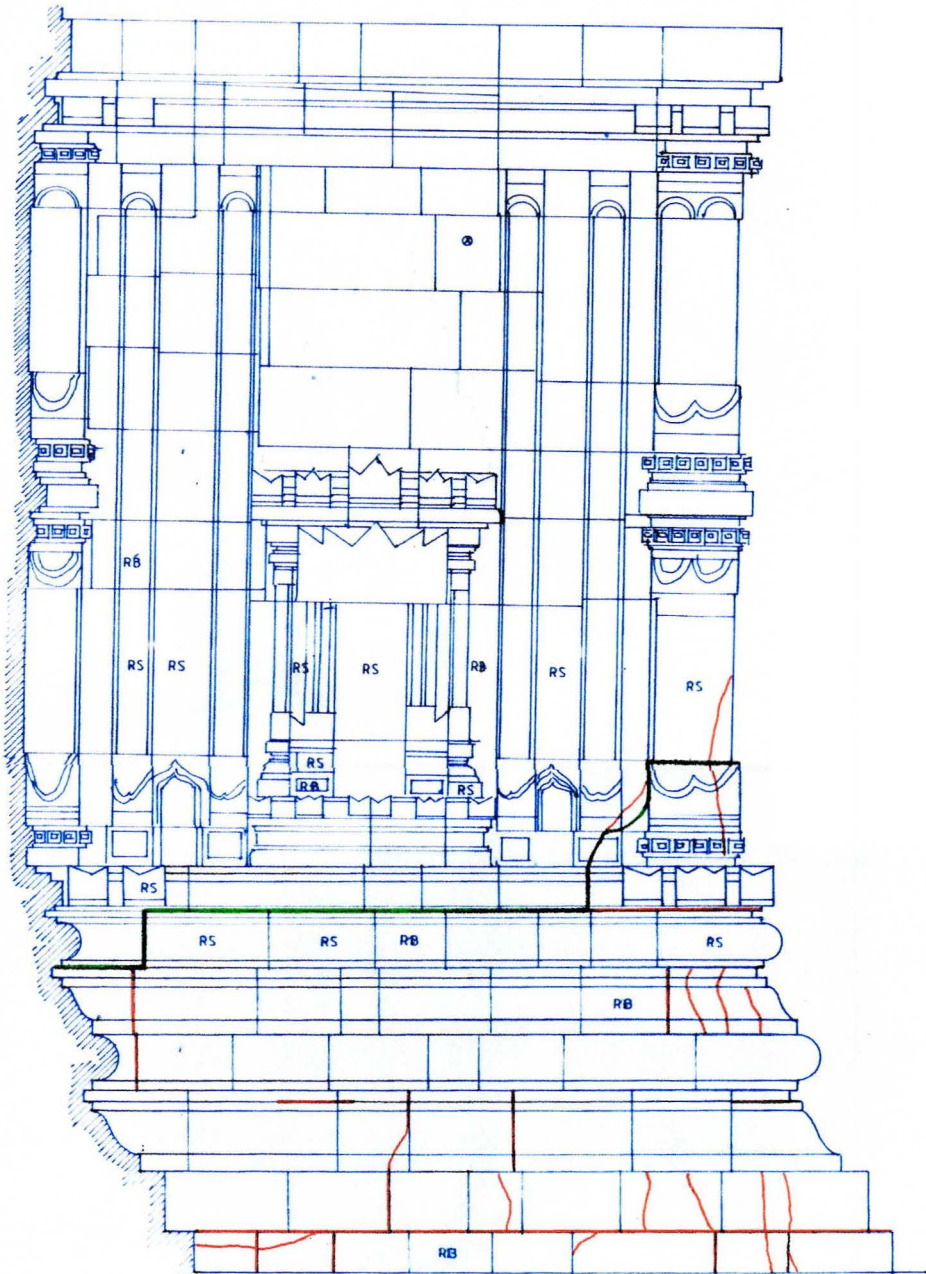

Remark

Area XII

— Craking and open joint stone

Siwa Temple The Body Part I

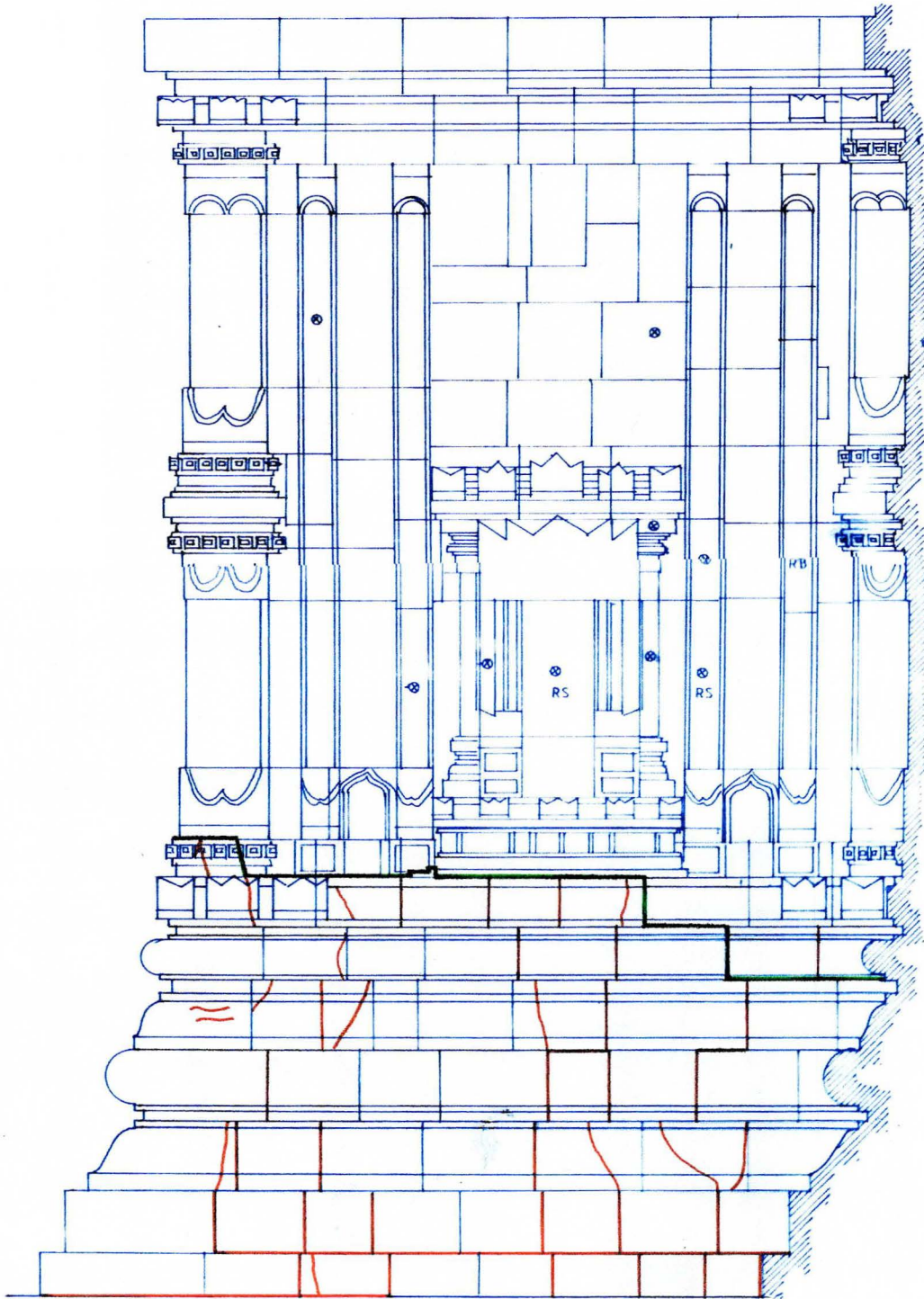

Area XIII

Remark

— Cracking and open joint stone

Siwa Temple The Body Part I

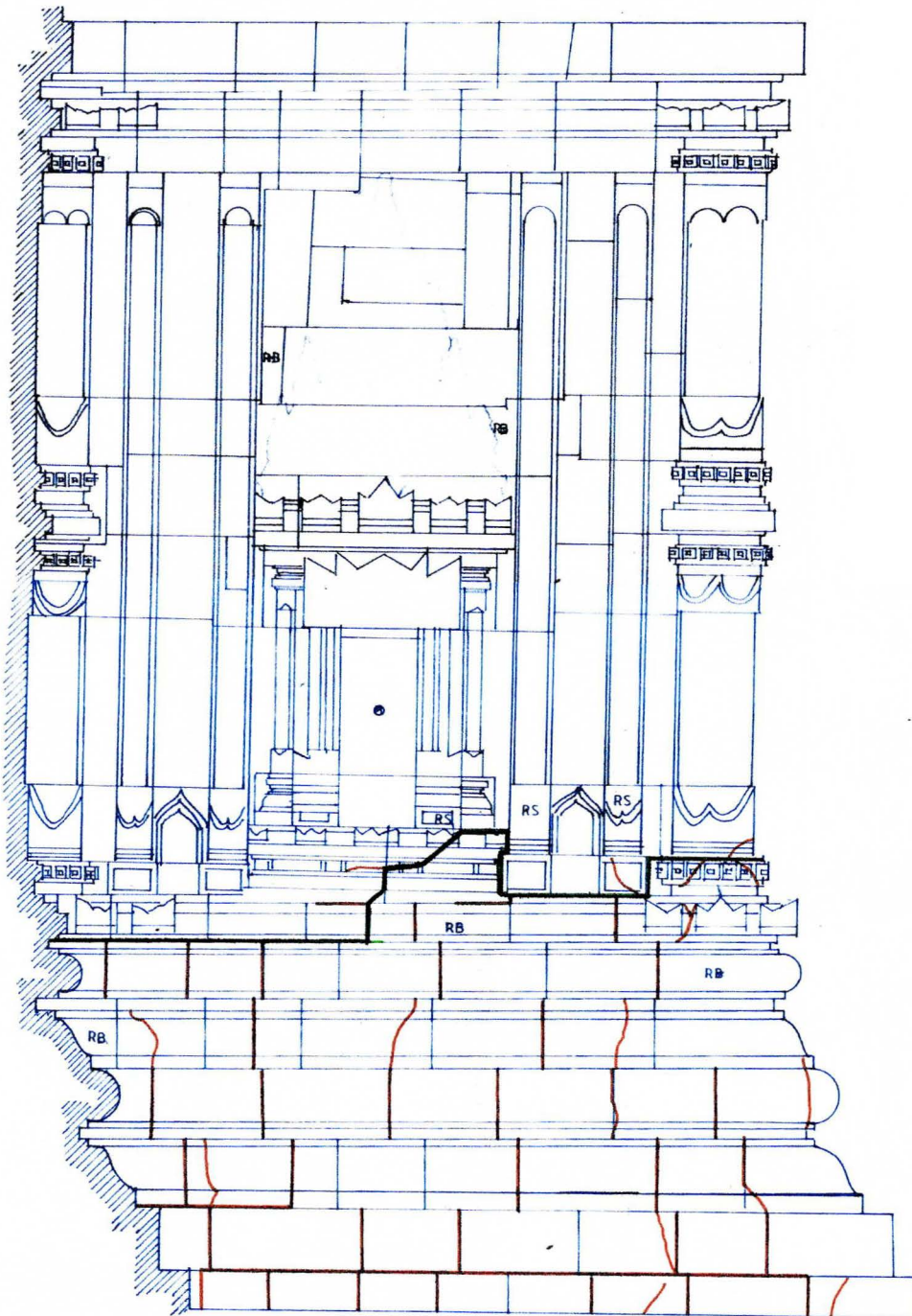

BIDANG XIV

Area XIV

Remark

— Cracking and open joint stone

Siwa Temple The Body Part I

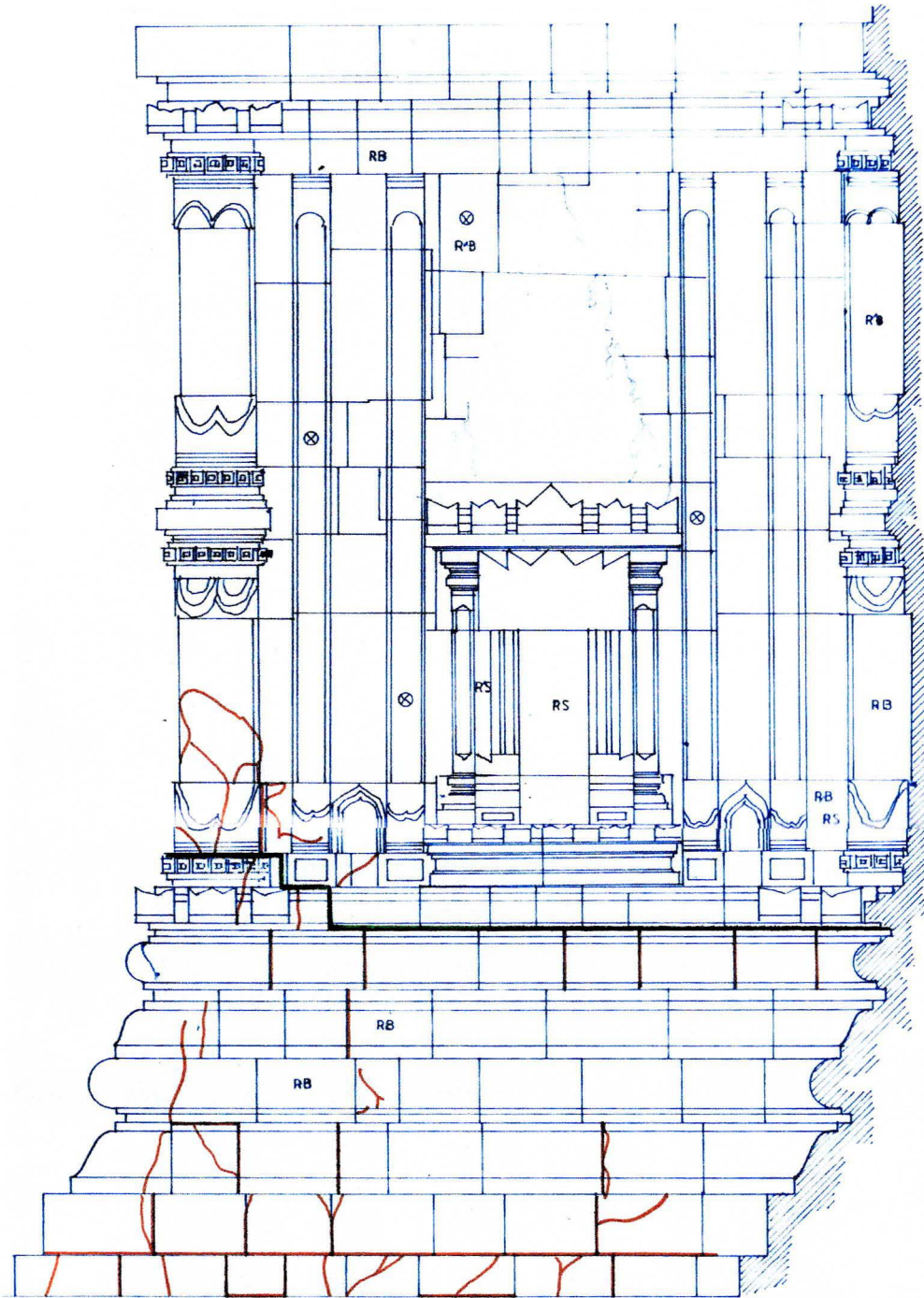

Remark

Area XV



Craking and open joint stone

Siwa Temple The Body, Level I

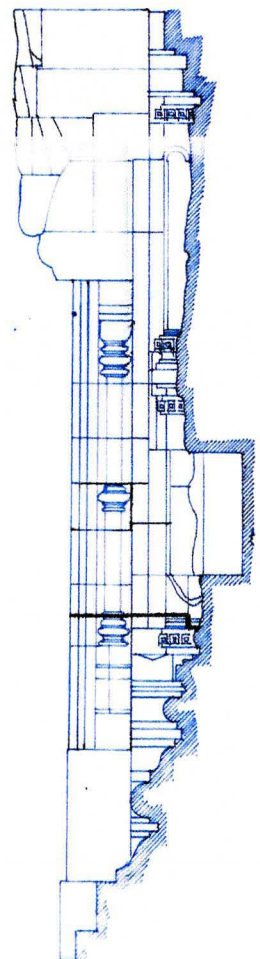
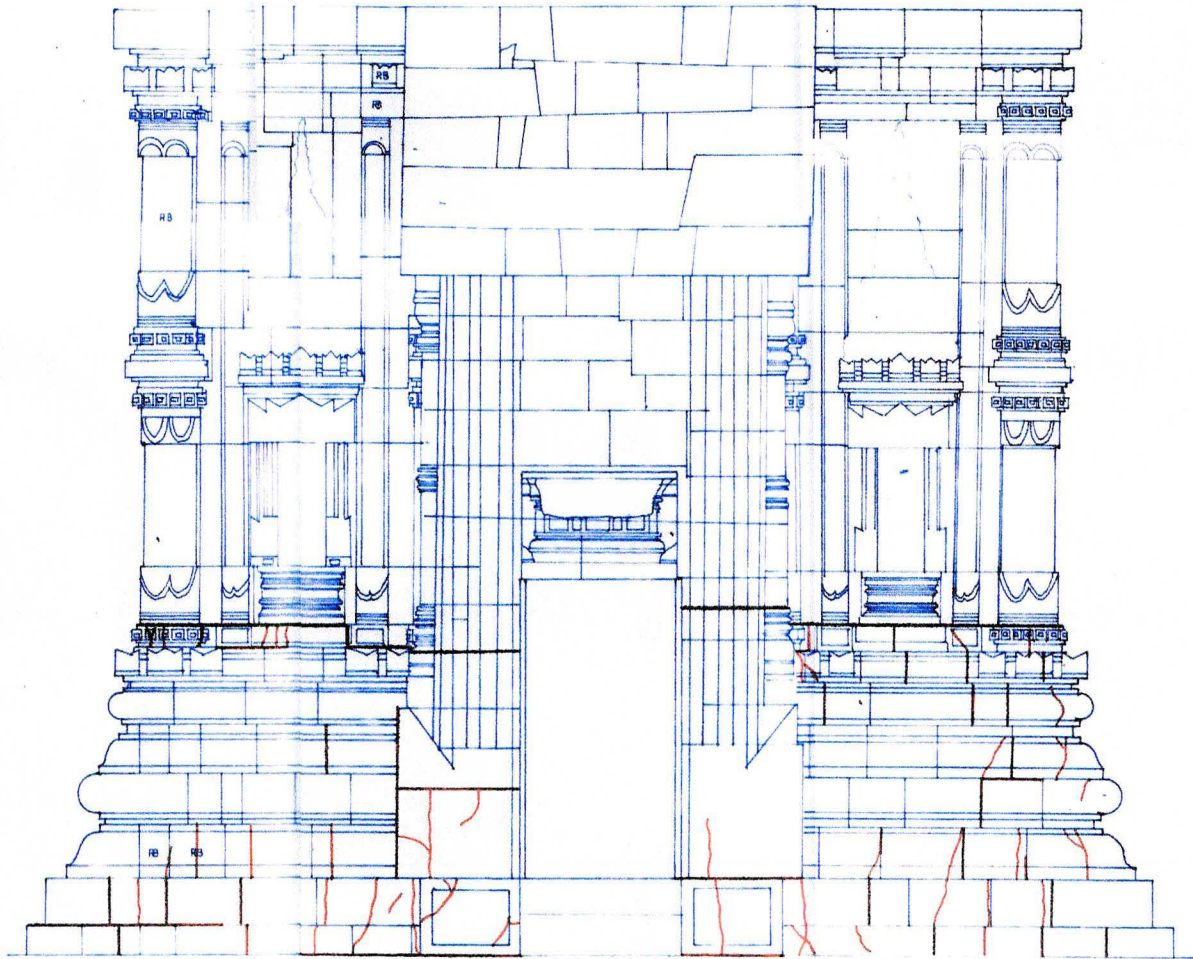
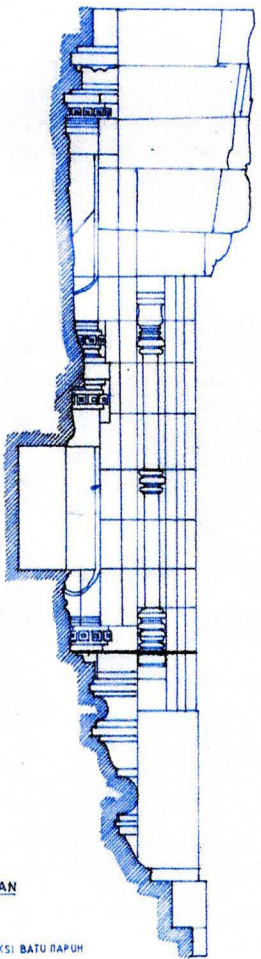

GAN
SEKSI BATU RAPUH

Remark

Area XVI

— Cracking and open joint stone

Siwa Temple The Body, Level I

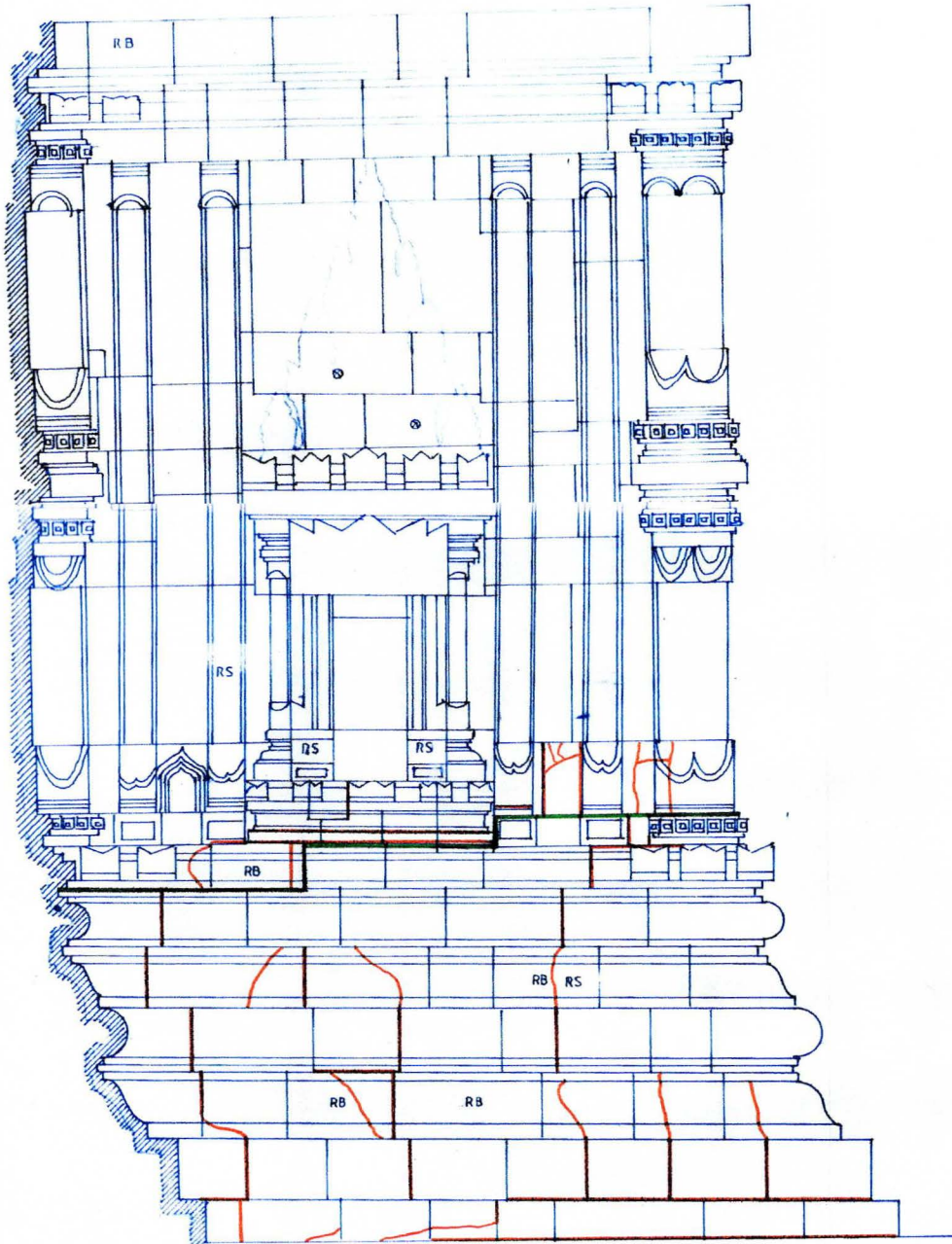

Remark

Area XVII

— Cracking and open joint stone

Siwa Temple The Body, Level I

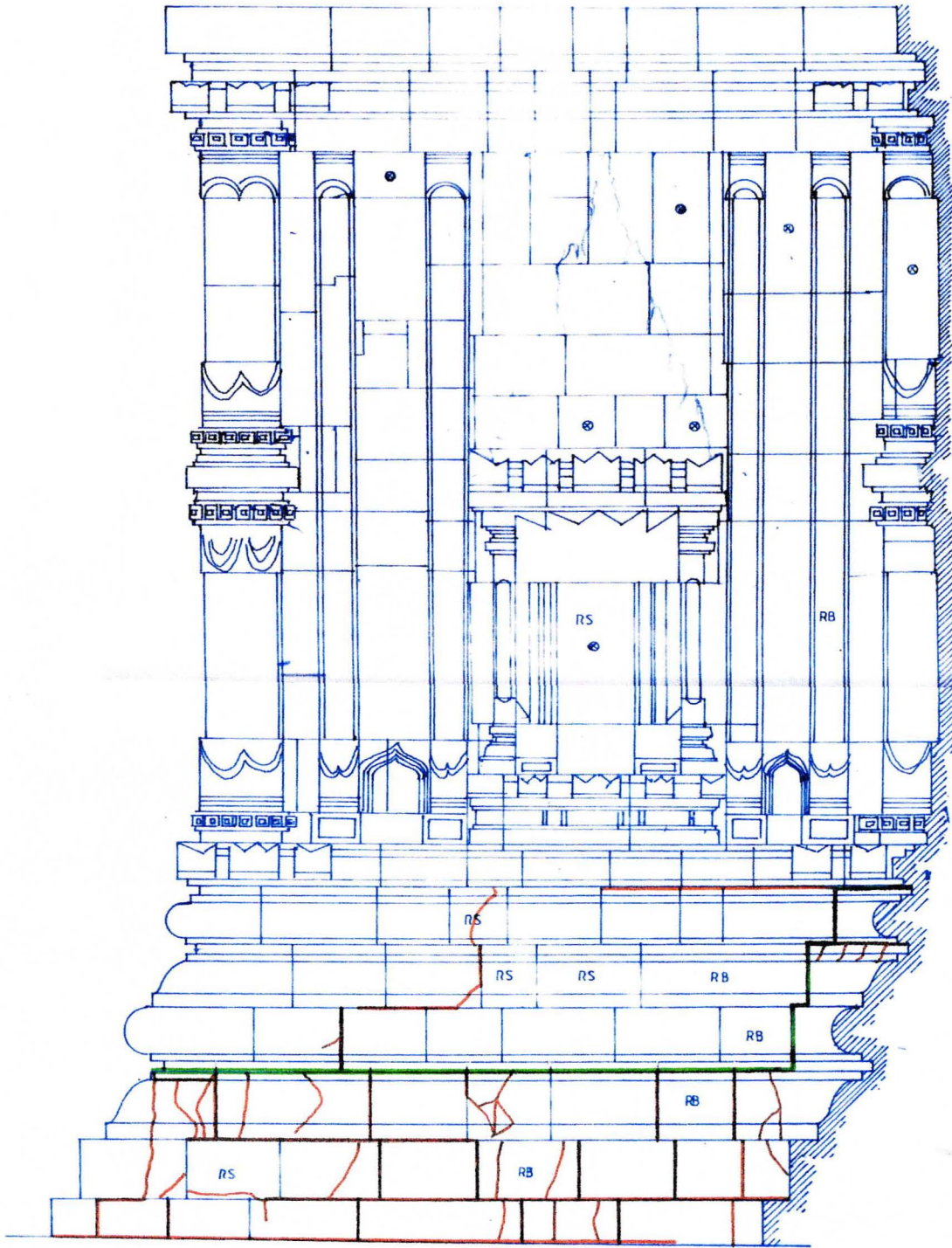

Remark

Area XVIII

— Craking and open joint stone

Siwa Temple

The Body, Level I

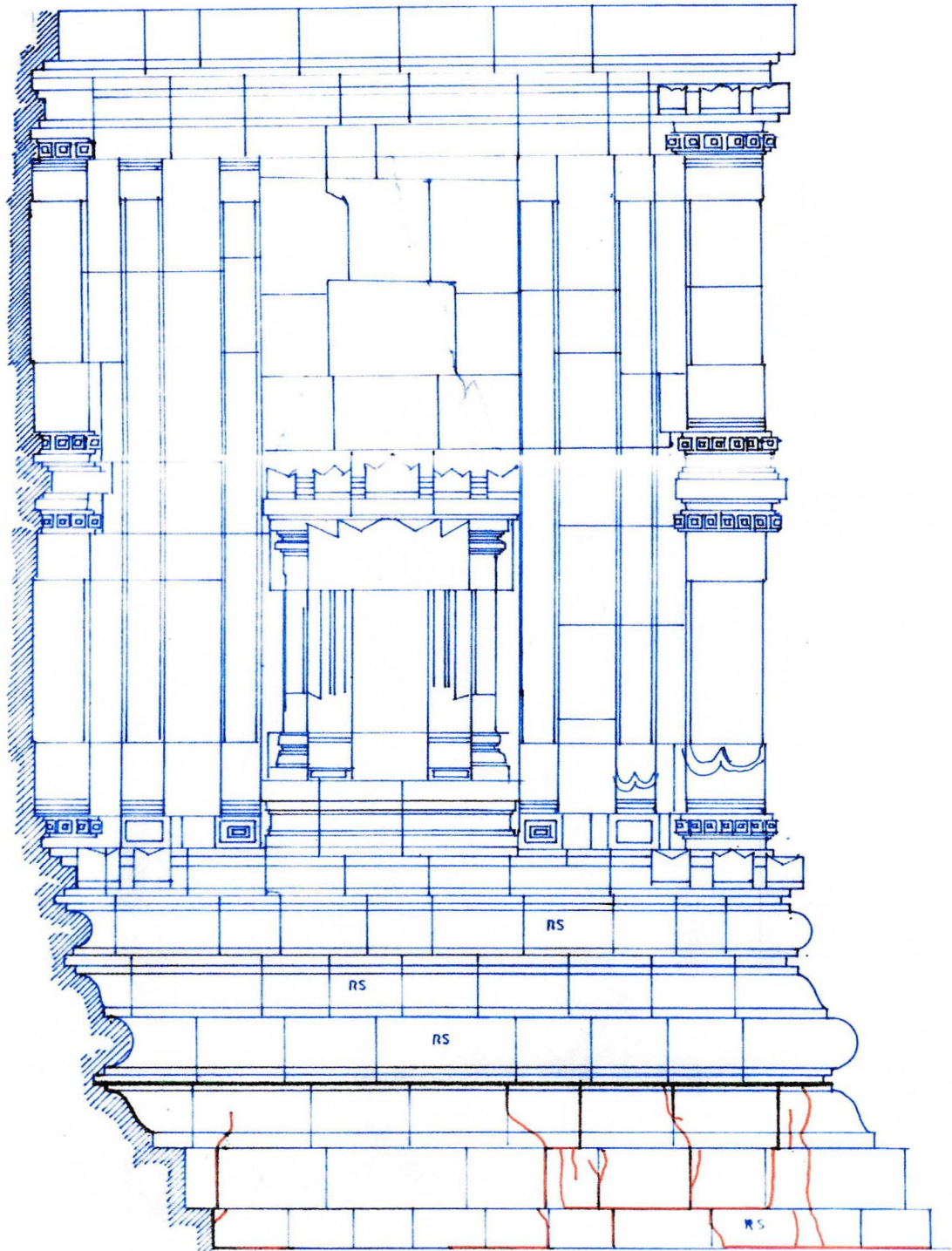

Remark

Area XIX



Craking and open joint stone

Siwa Temple

The Body, Level I

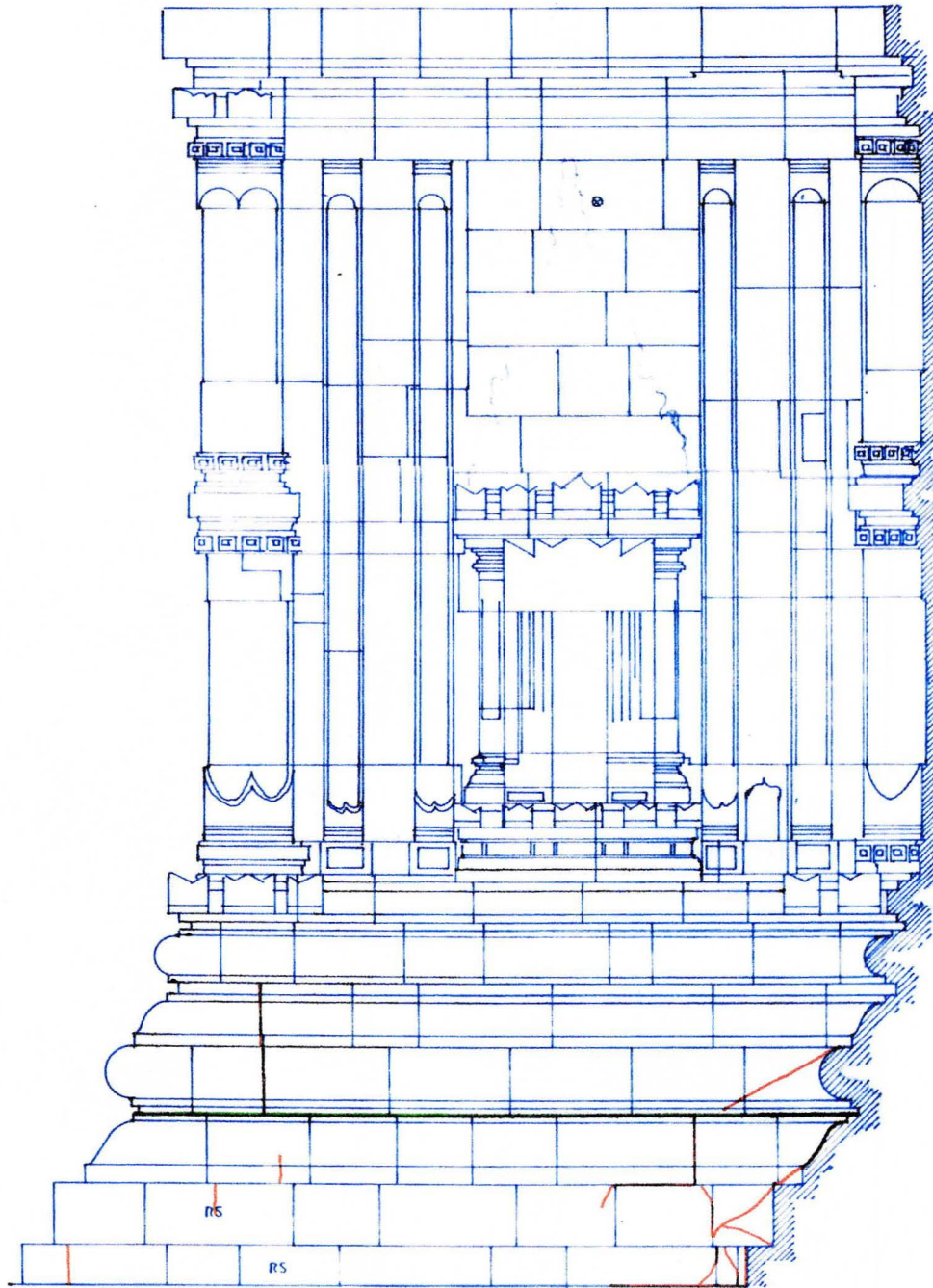

Remark

Area XX

— Cracking and open joint stone

Candi Siwa
Lorong Bilik Selatan
(South chamber path of Siwa temple)

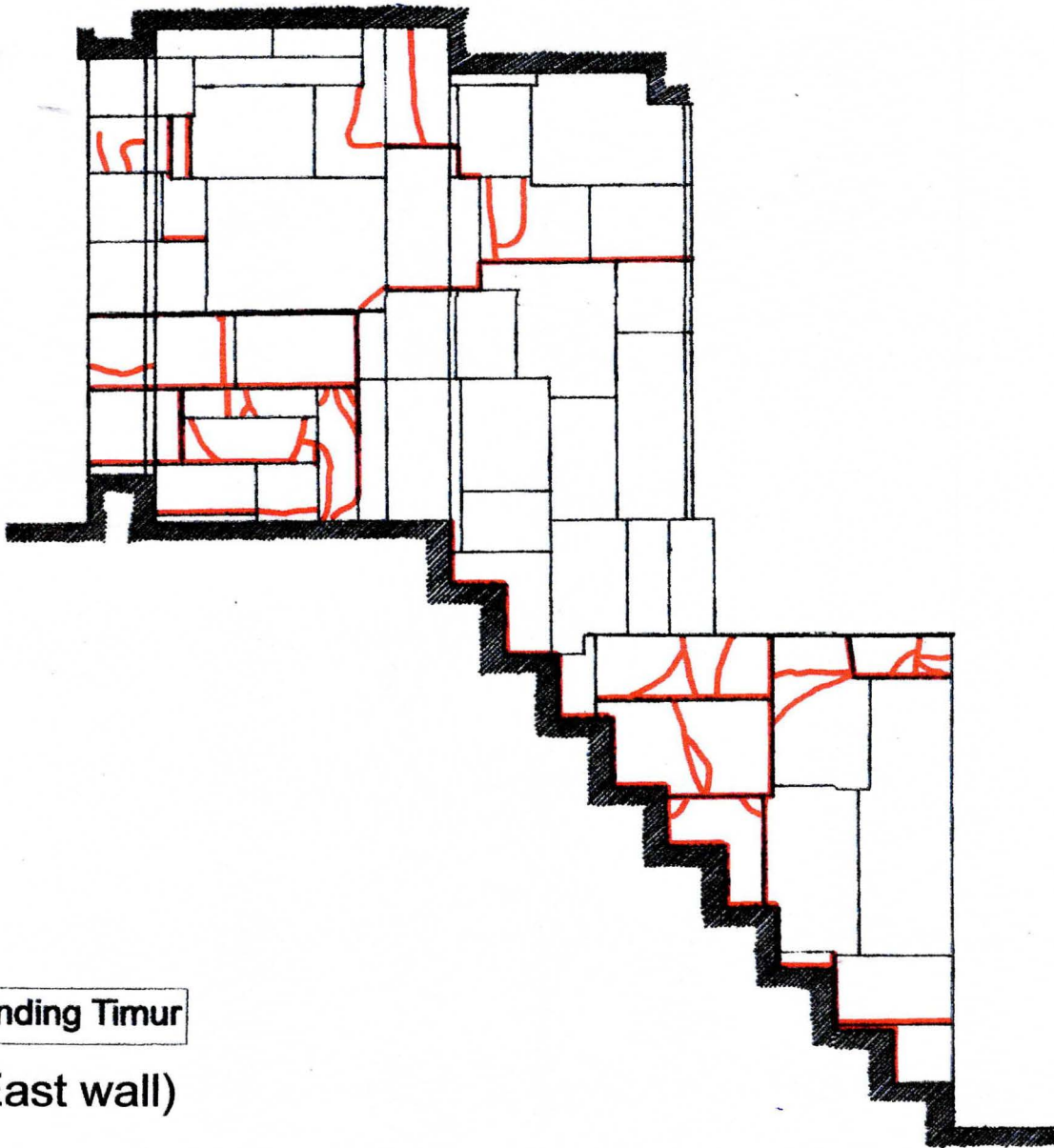

Dinding Timur
(East wall)

Candi Siwa
Lorong Bilik Selatan
(south chamber path of Siwa temple)

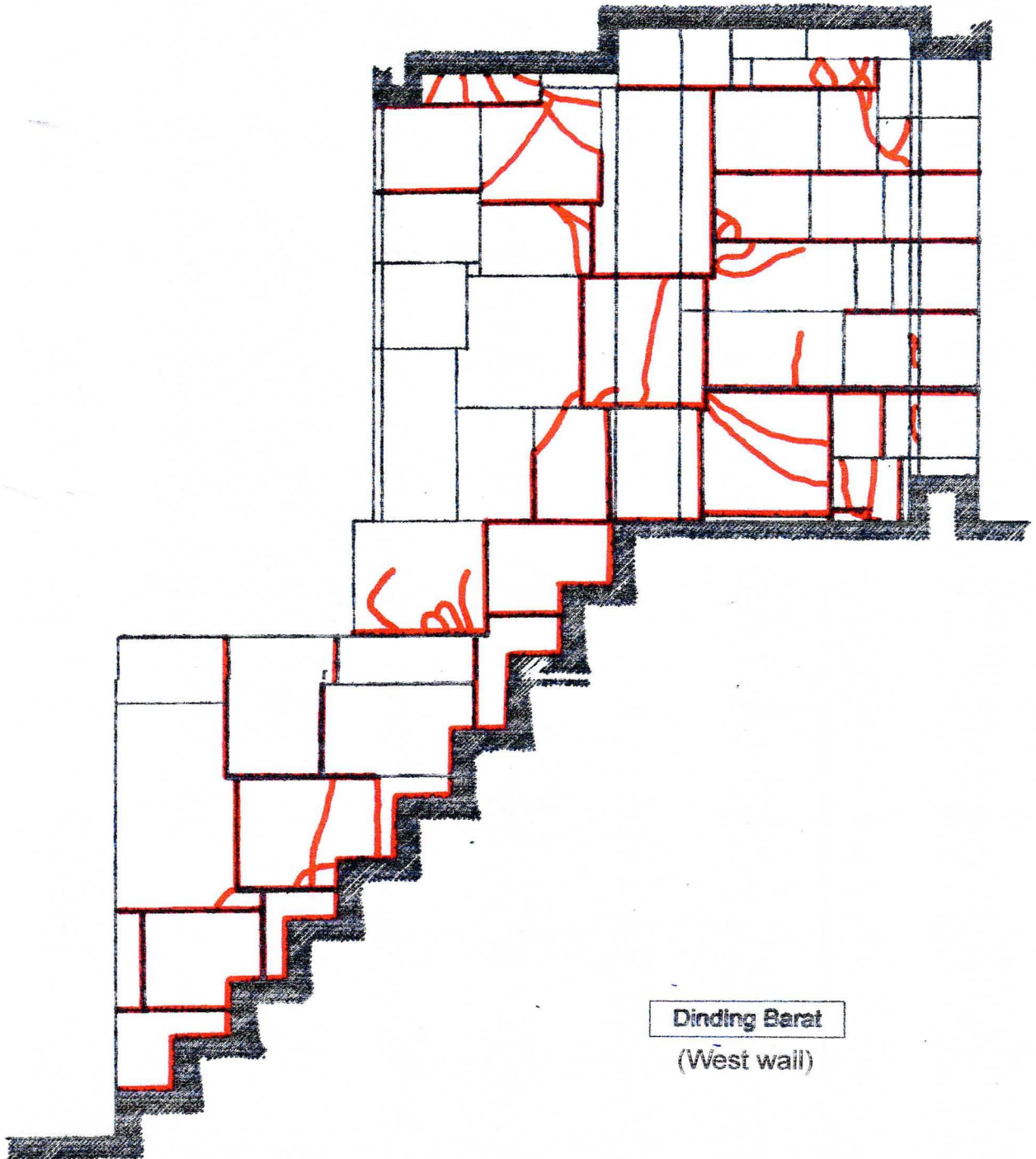

Candi Siwa
Lorong Bilik Barat
(West chamber path of Siwa temple)

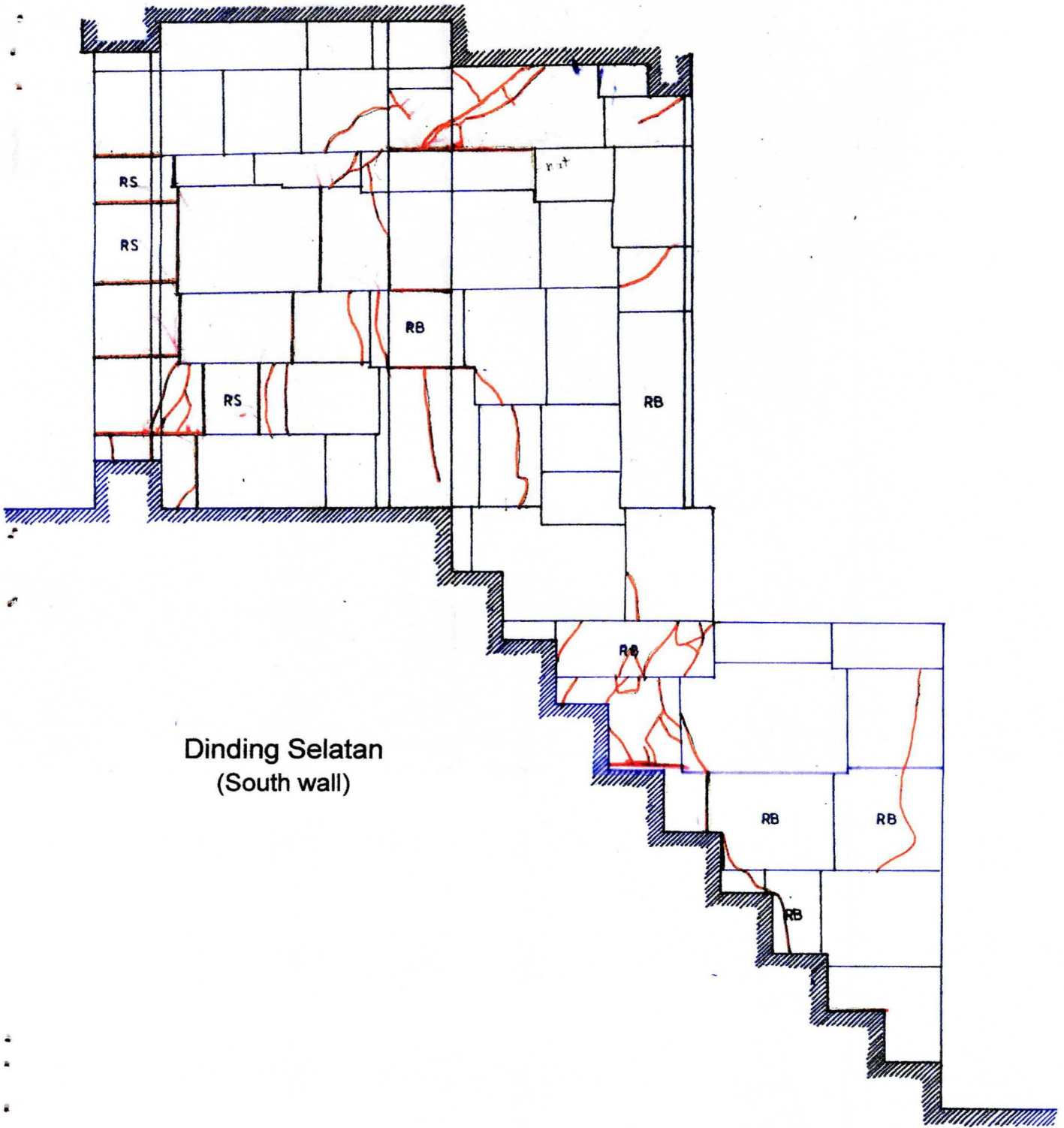

Candi Siwa
Lorong Bilik Barat
(West chamber path of Siwa temple)

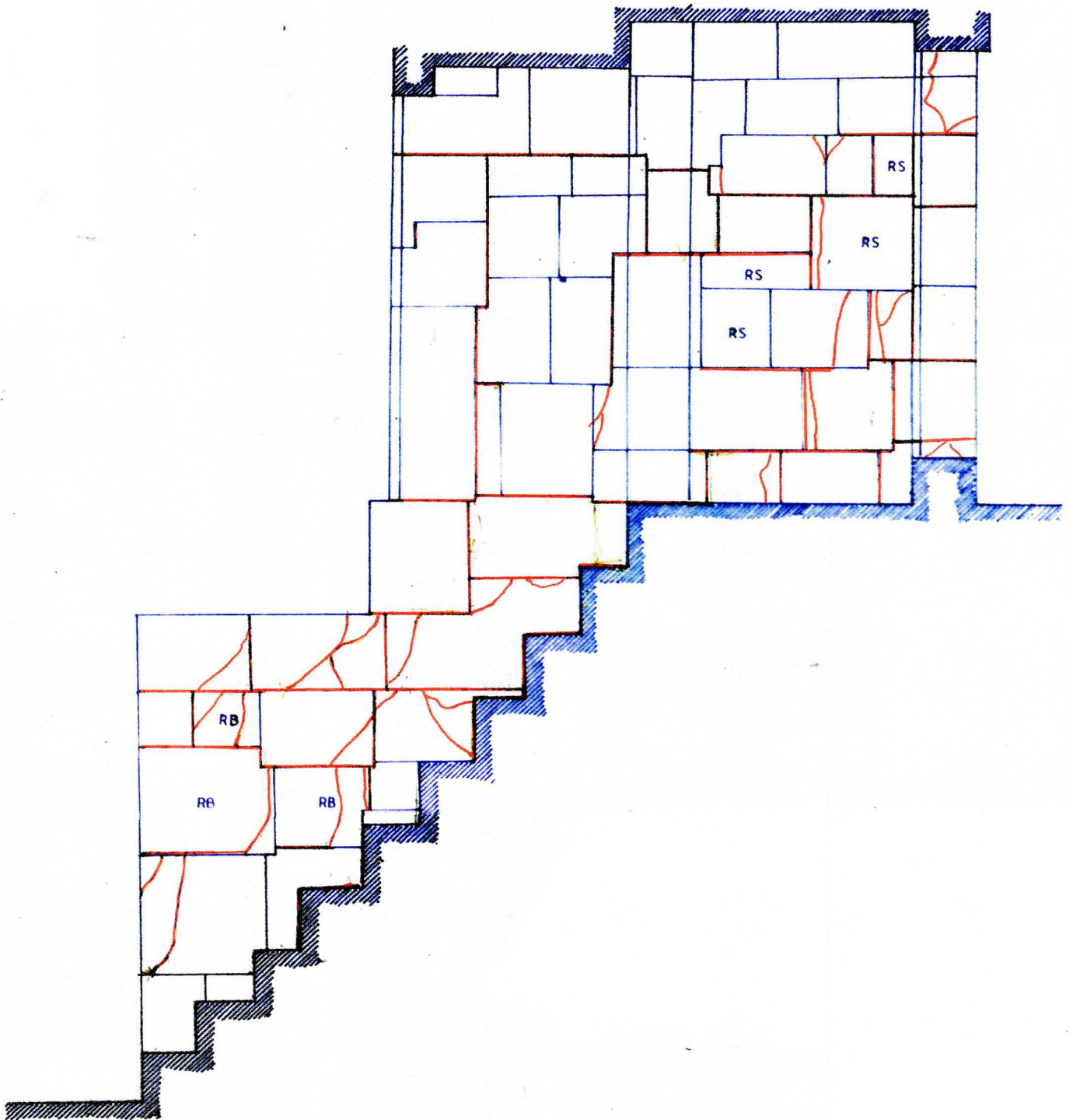

Dinding Utara
(North wall)

Candi Siwa

Lorong Bilik Utara

(North chamber path of Siwa temple)

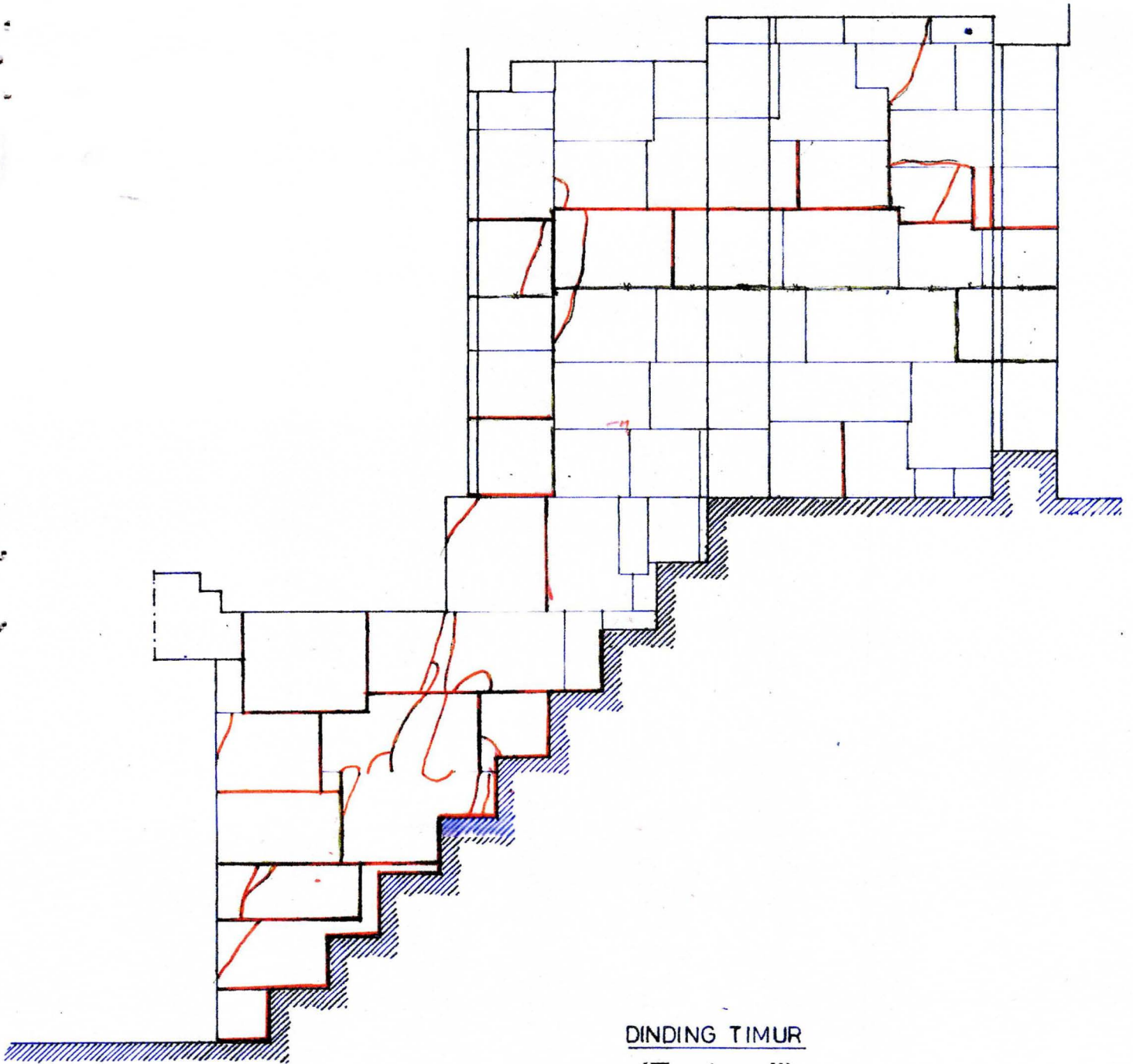

DINDING TIMUR
(East wall)

Candi Siwa

Lorong Bilik Utara

(North chamber path of Siwa temple)

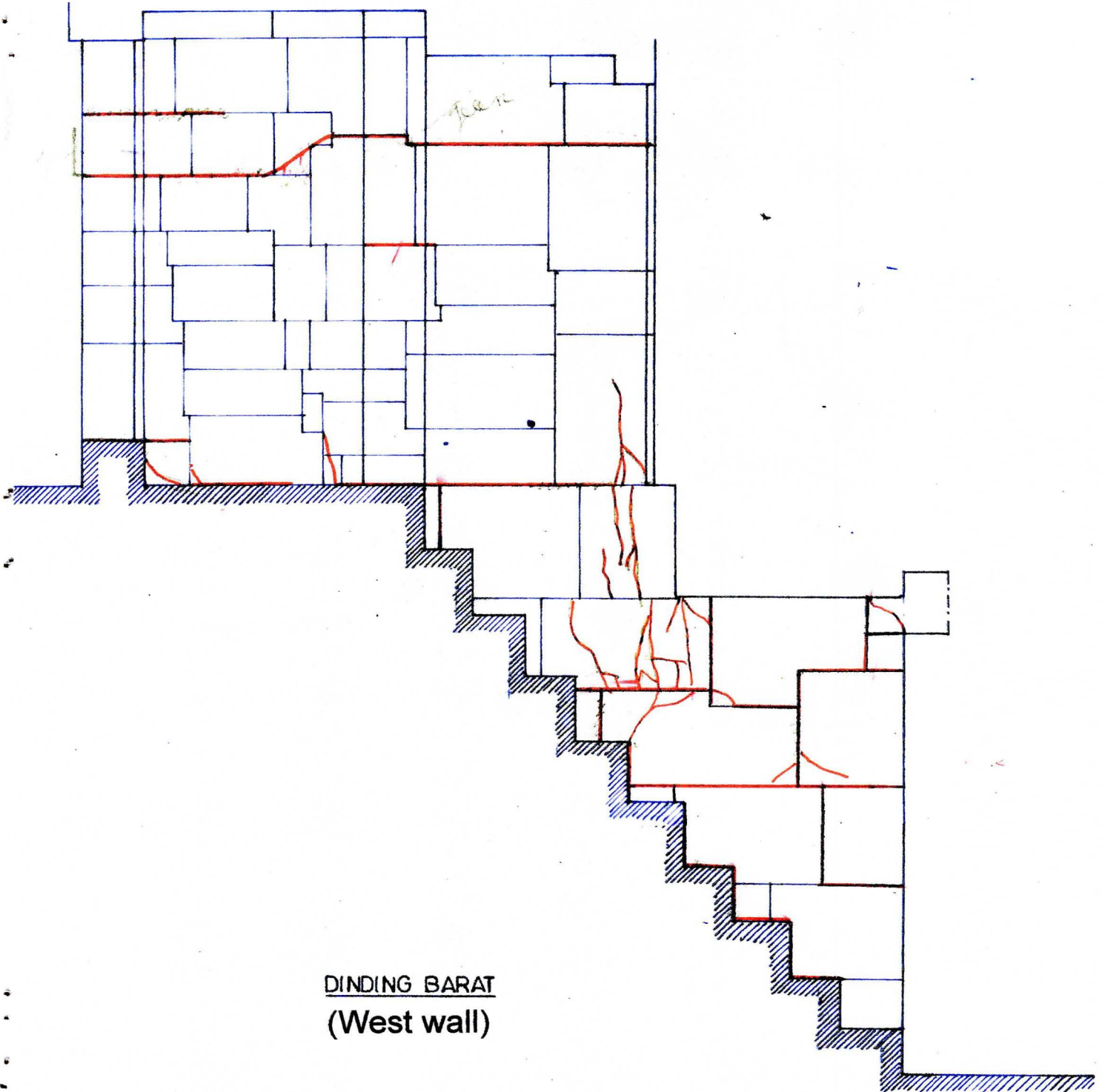

DINDING BARAT
(West wall)

Candi Siwa

Bilik Utama

(Main chamber of Siwa temple)

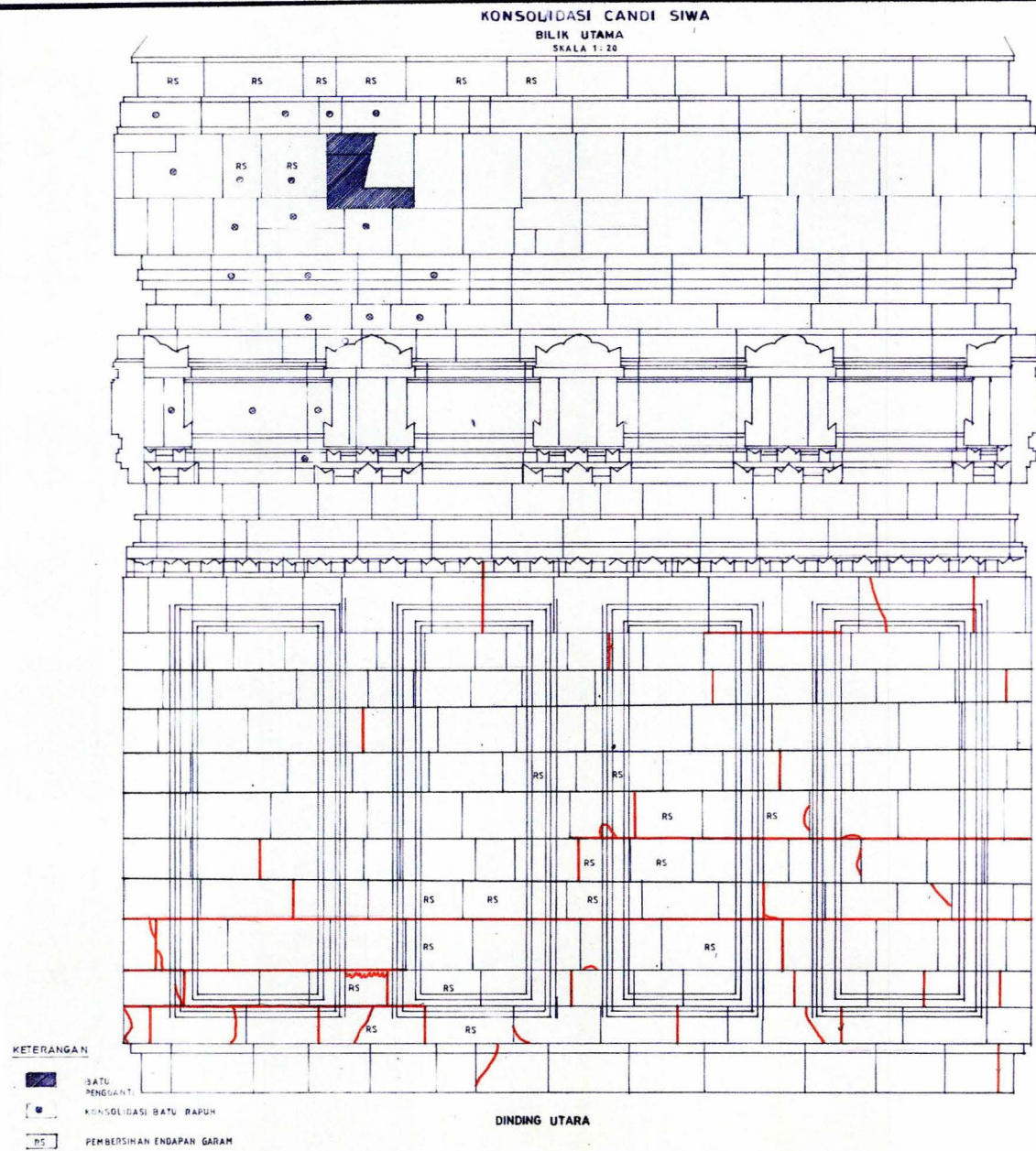

Dinding Utara

(North wall)

Candi Siwa
Bilik Utama
(Main chamber of Siwa temple)

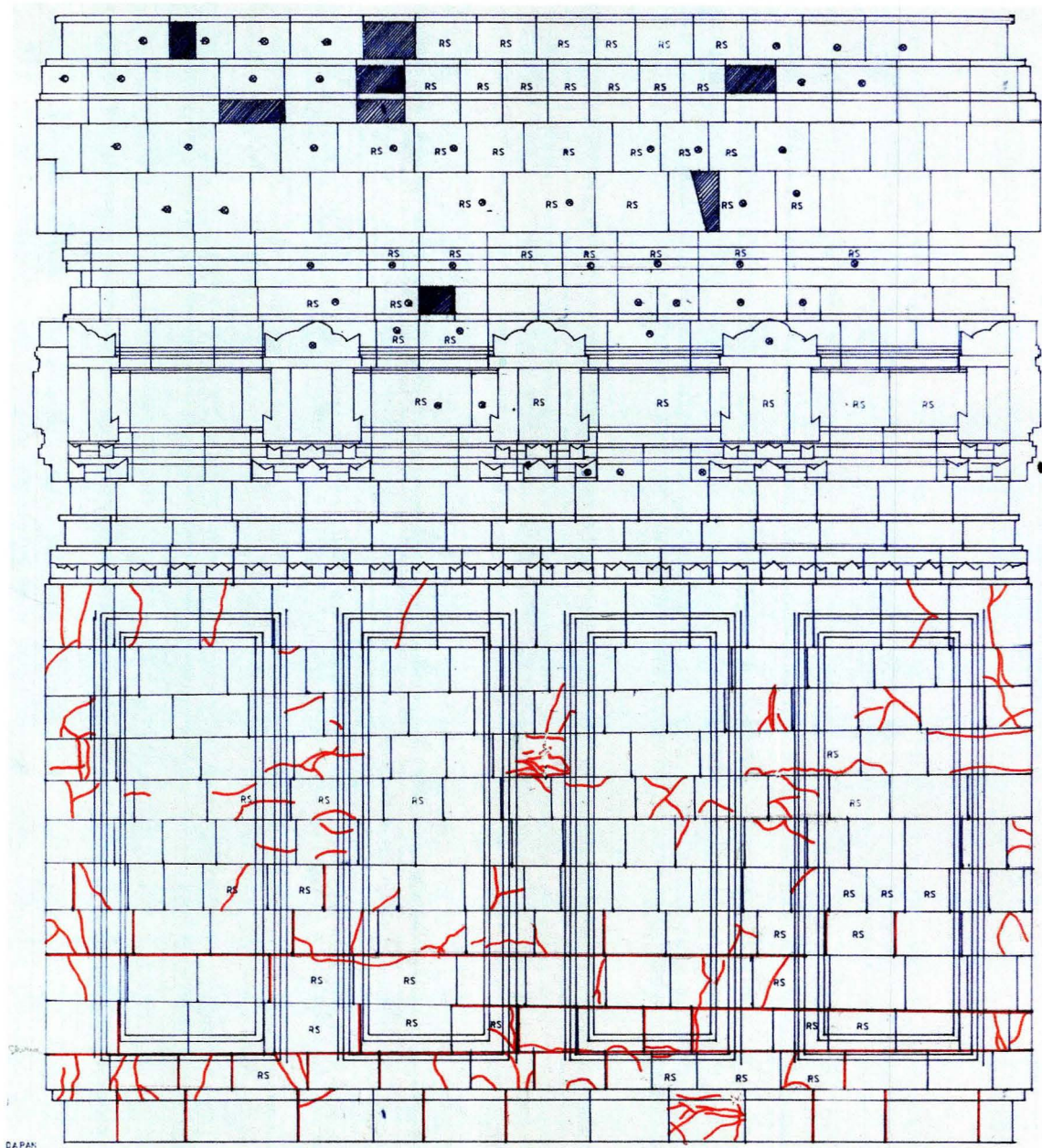

Dinding Barat
(West Wall)

Candi Siwa Bilik Selatan

(South chamber of Siwa Temple)

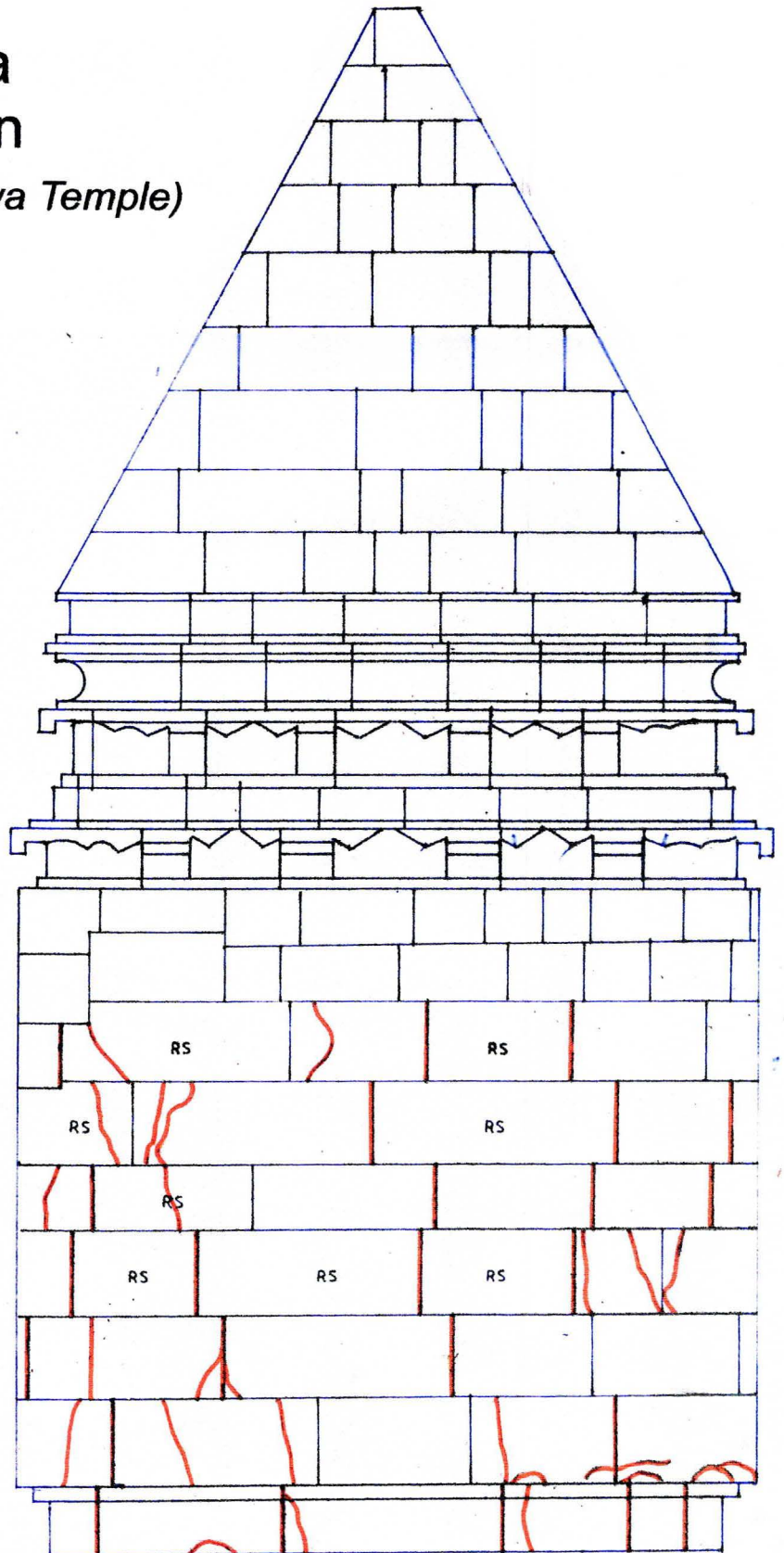

DINDING TIMUR

(East Wall)

Candi Siwa Bilik Selatan

(South chamber of Siwa Temple)

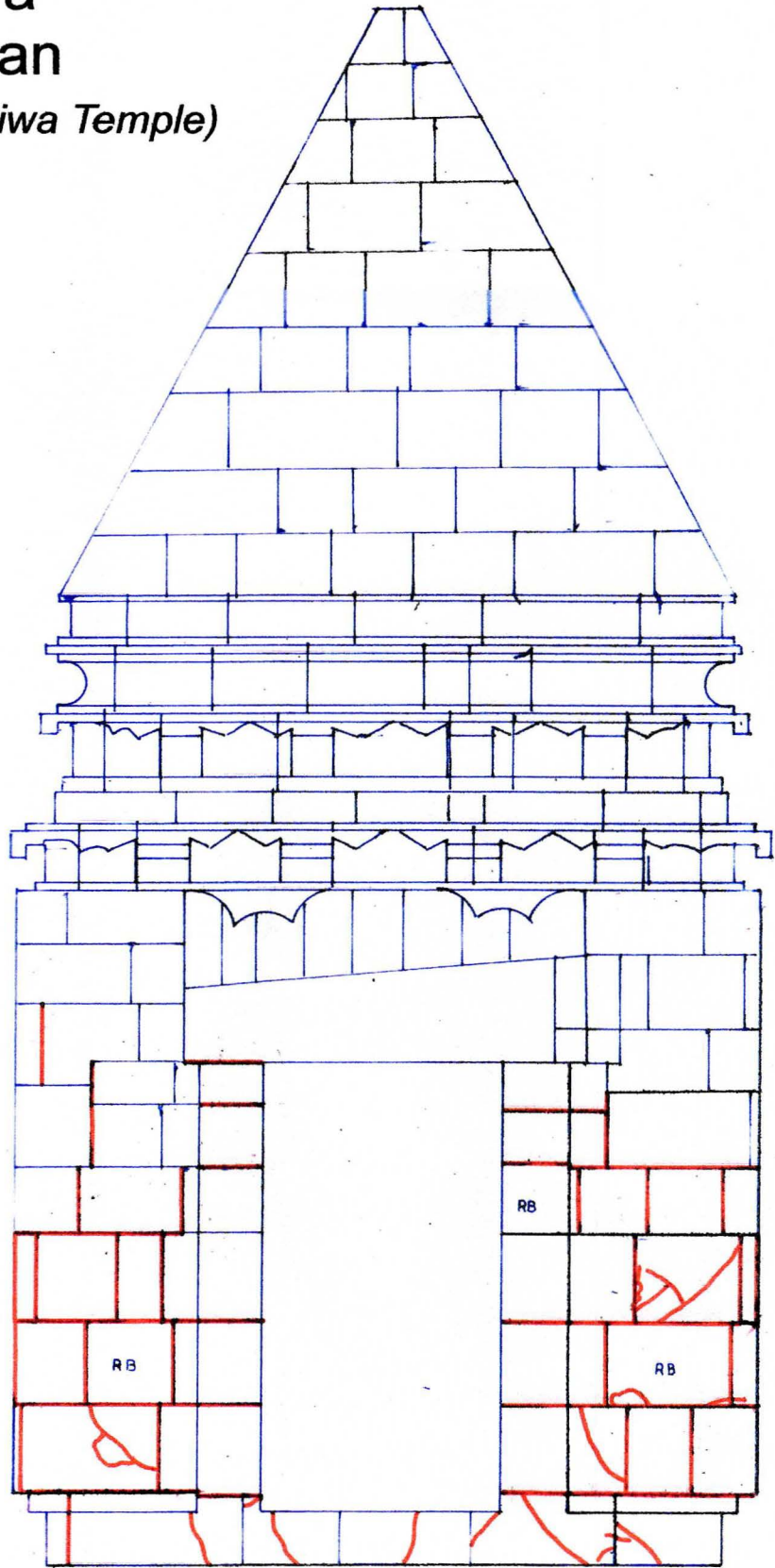

DINDING SELATAN
(South wall)

Candi Siwa Bilik Selatan

(South chamber of Siwa Temple)

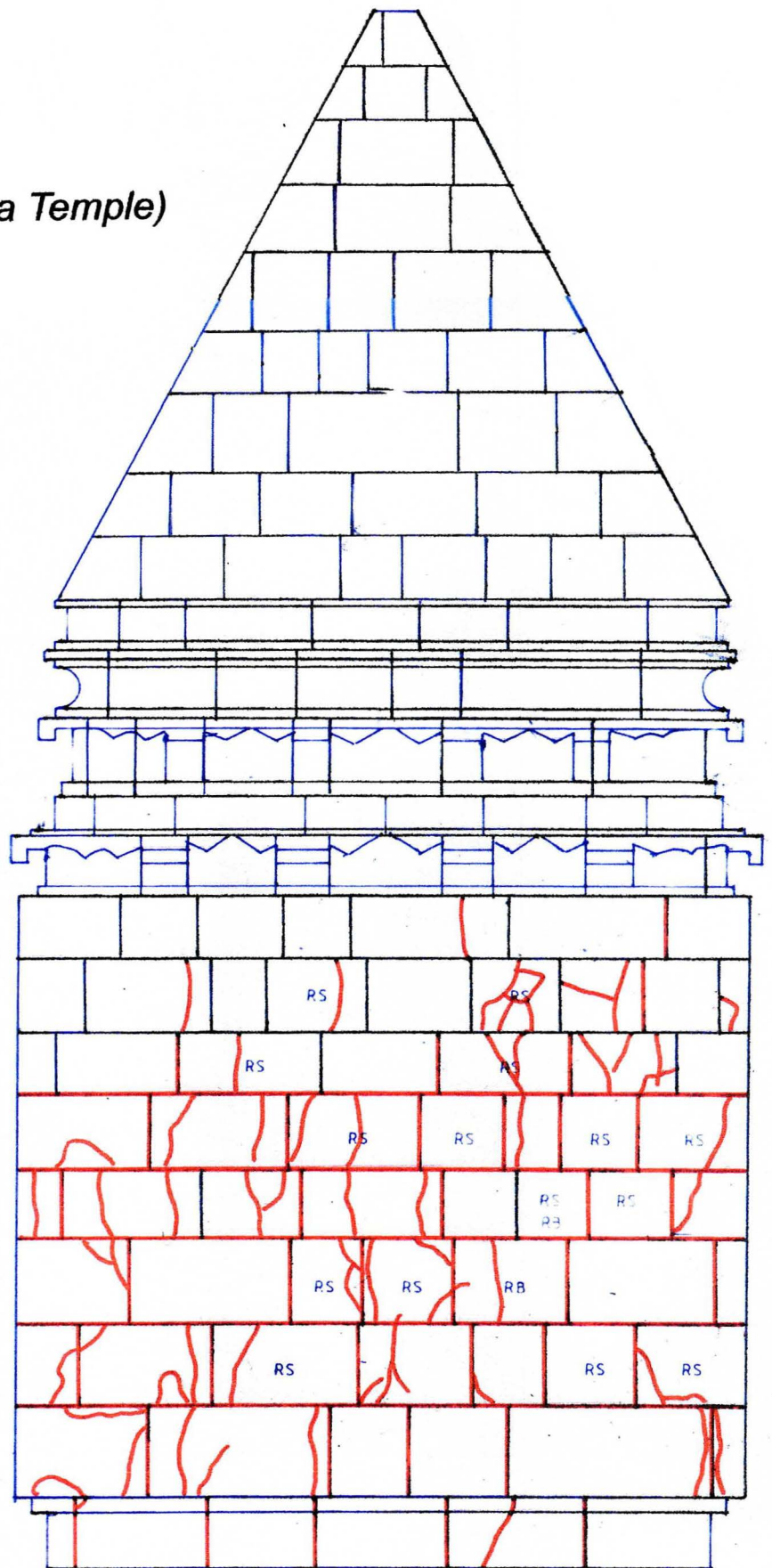

DINDING BARAT
(West wall)

Candi Siwa Bilik Selatan

(South chamber of Siwa Temple)

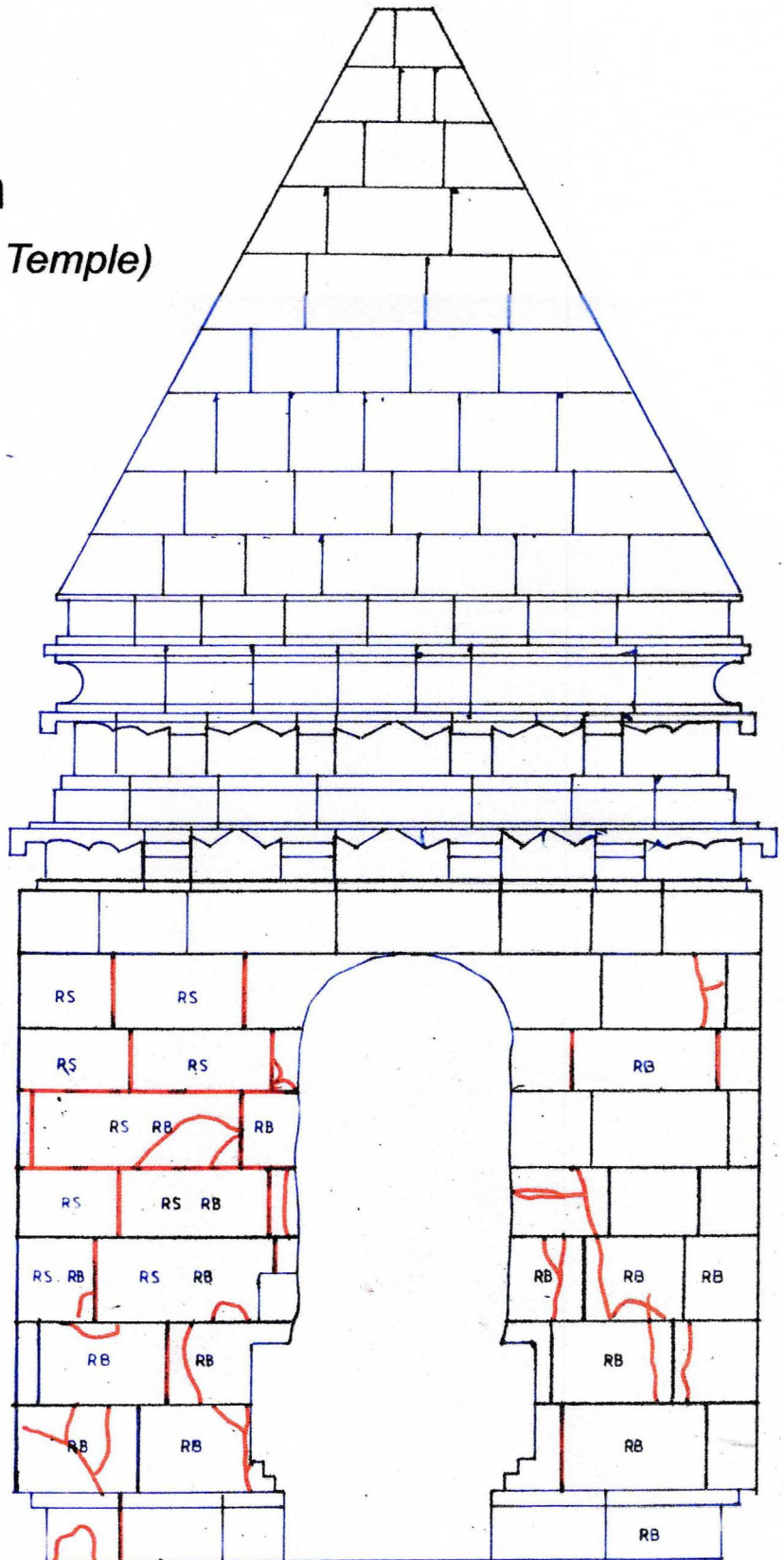

DINDING UTARA
(North wall)

Candi Siwa bilik barat

(West chamber of Siwa temple)

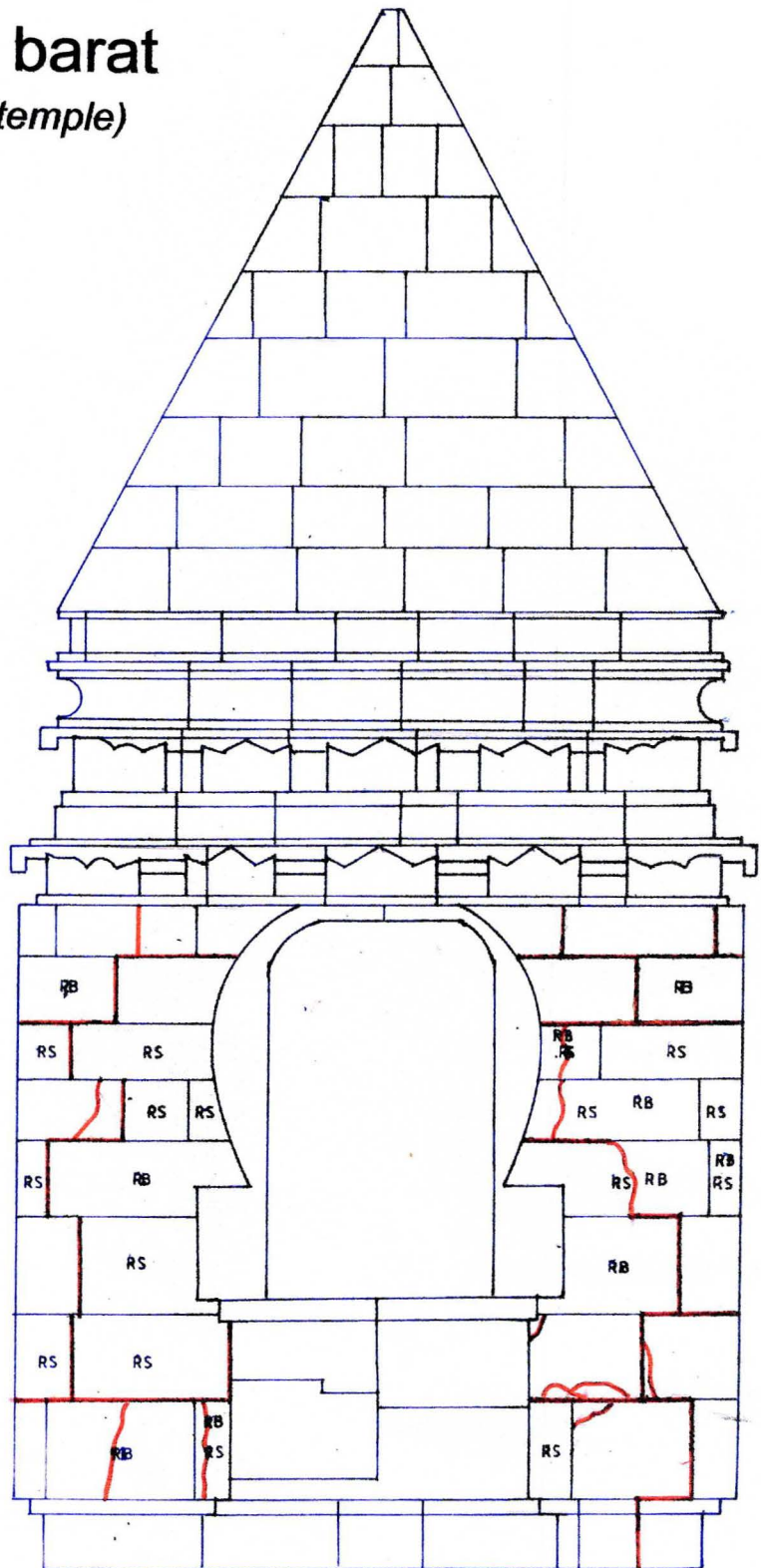

Dinding Timur

(East Wall)

Candi Siwa Bilik Barat
(West chamber of Siwa Temple)

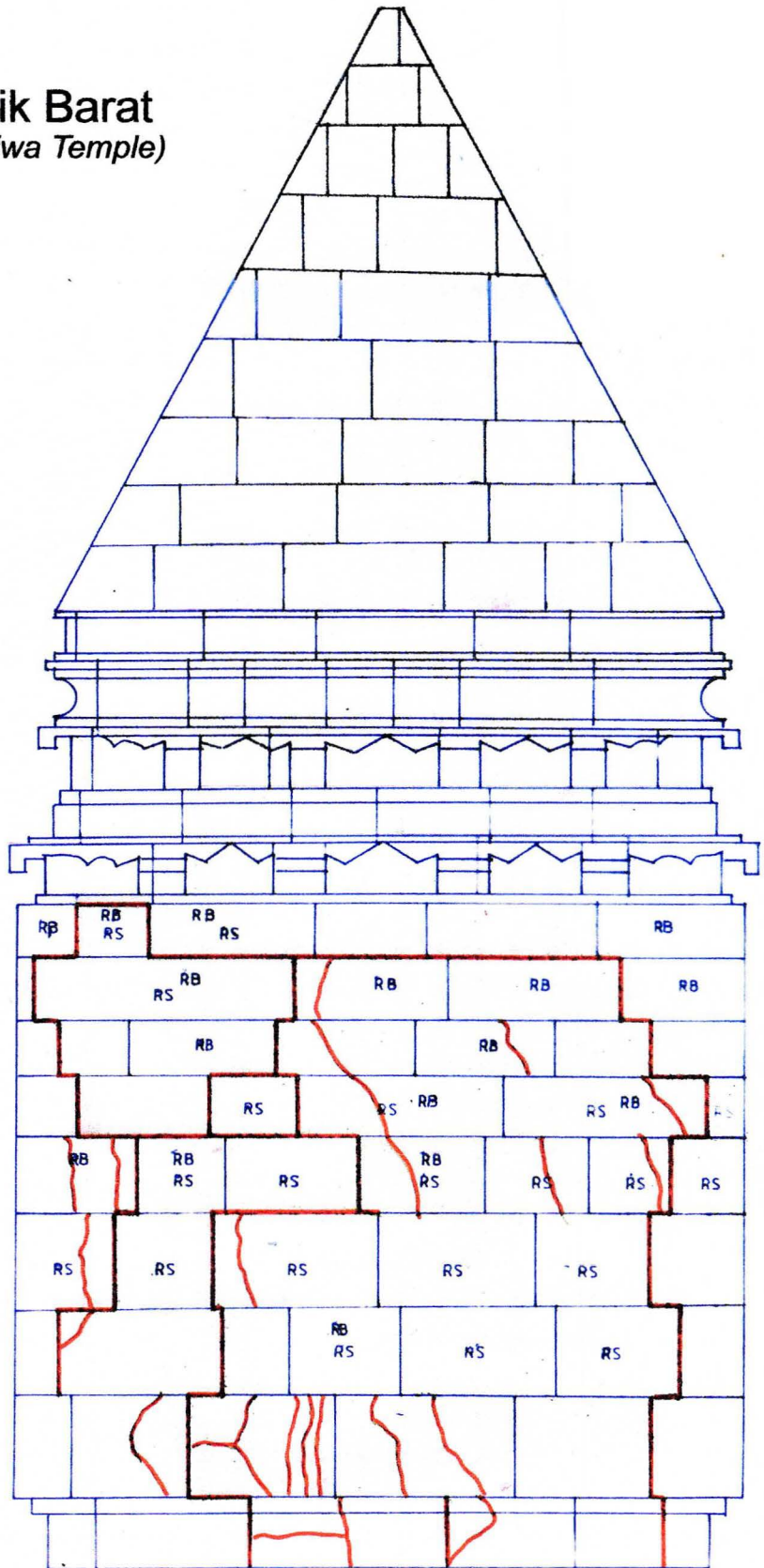

Dinding Selatan
(South wall)

Candi Siwa Bilik Barat

(West chamber of Siwa temple)

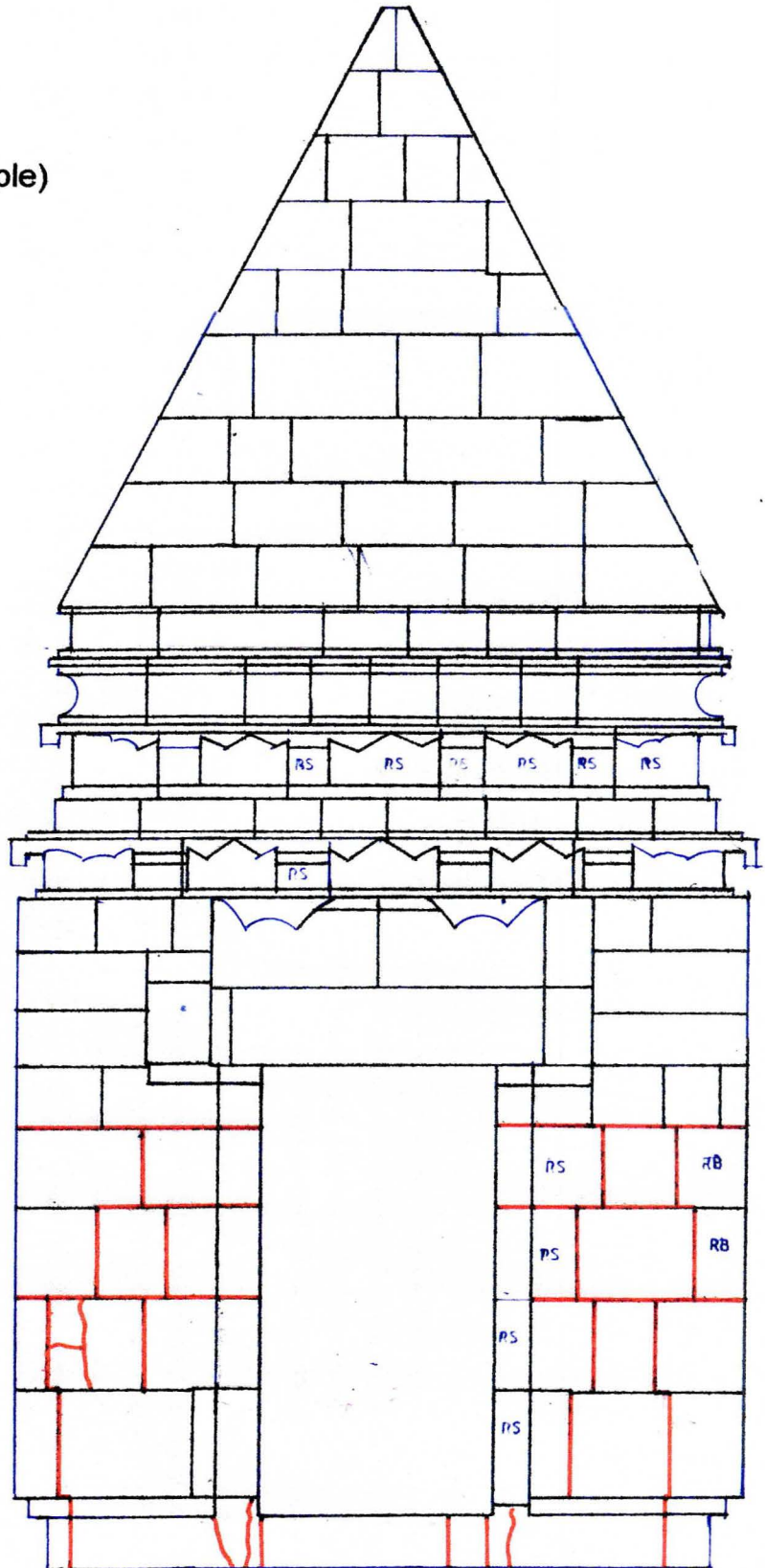

Dinding Barat
(West wall)

Candi Siwa Bilik Barat

(West chamber of Siwa temple)

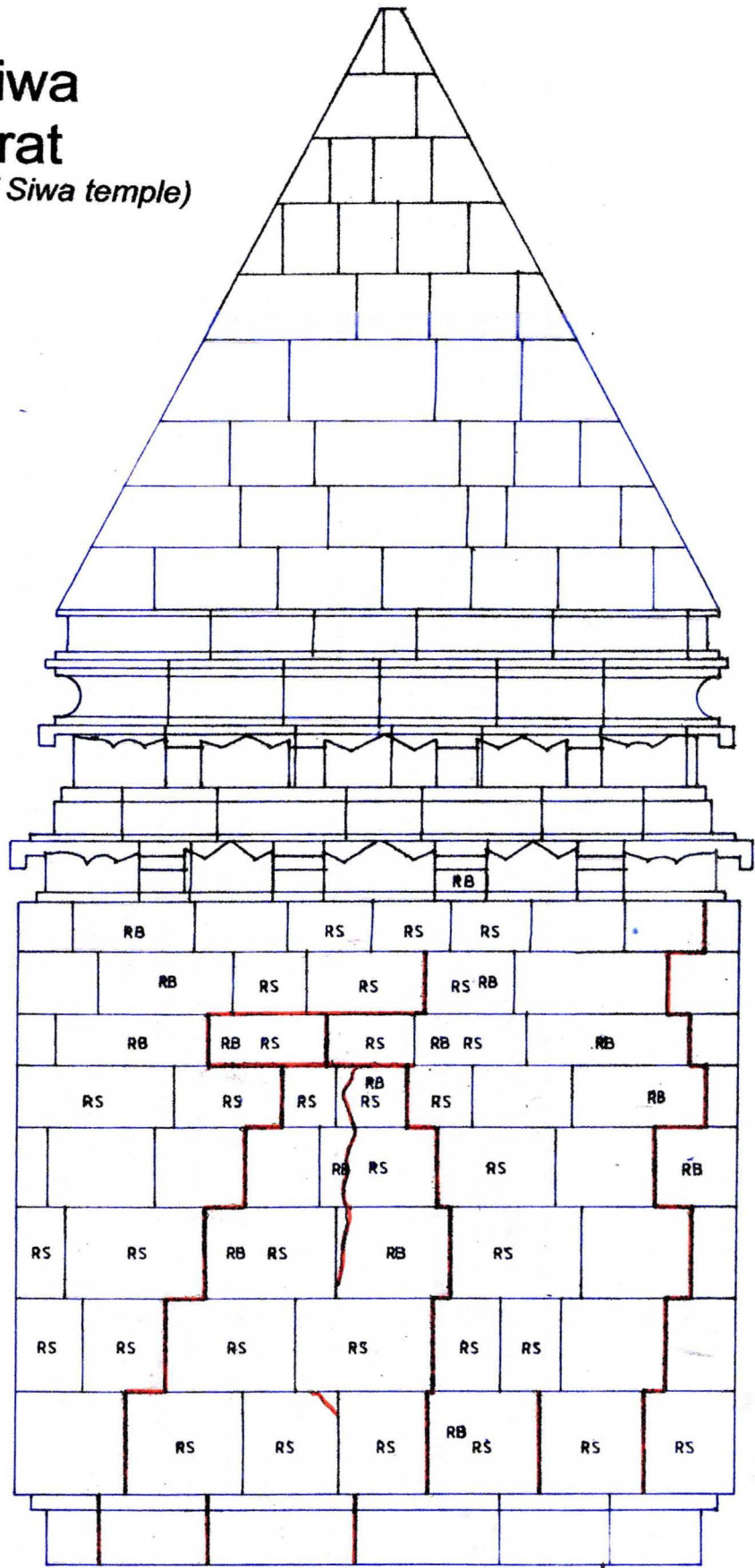

Dinding Utara
(North wall)

Candi Siwa Bilik Utara

(North chamber of Siwa Temple)

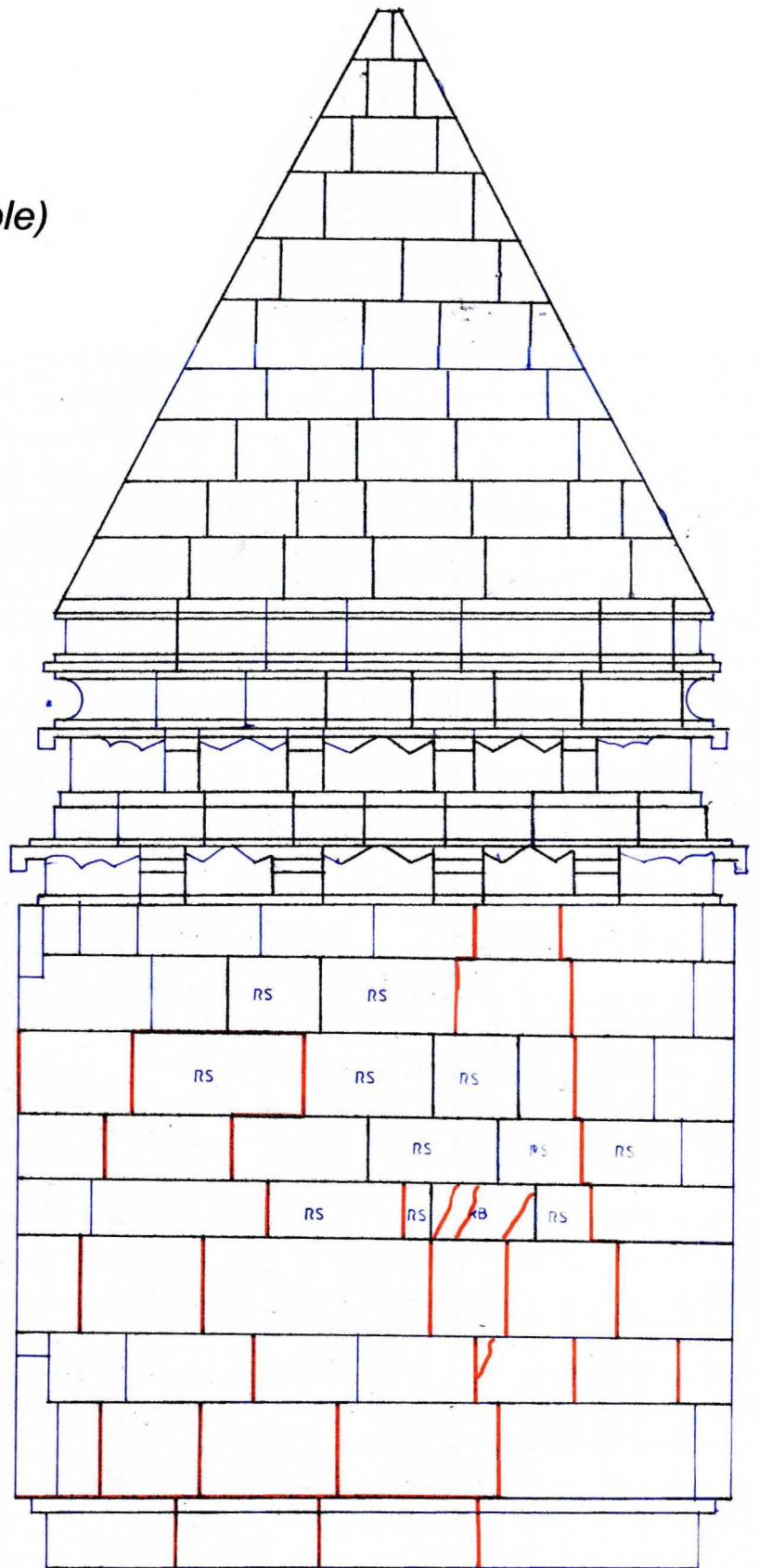

DINDING TIMUR
(East wall)

APPENDIX IV
CONSOLIDATION SYSTEM

Brahma Temple

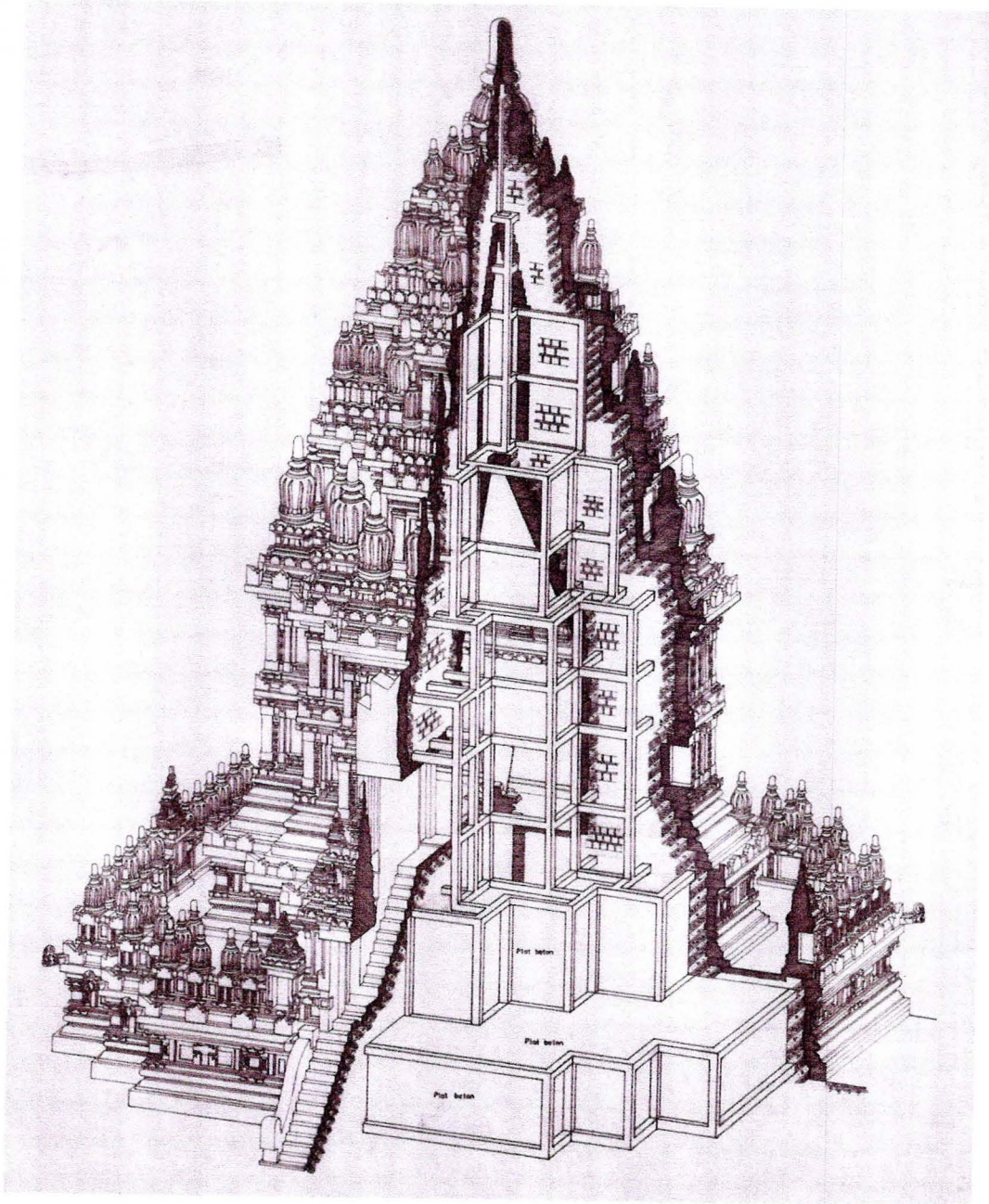

Isometric Framework of Concrete

Isometric Brahma

BATU LAPIS BAGUN BATRA PUNCAK
(LAPISAN BATU NO 84,85,86, 87,88,89,90,91,92
72,73,74,75,76,DAN 77).

PENAMPANG PQ
SKALA 1:50

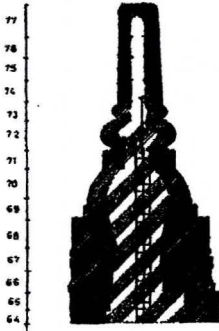

DENAH
SKALA 1:100

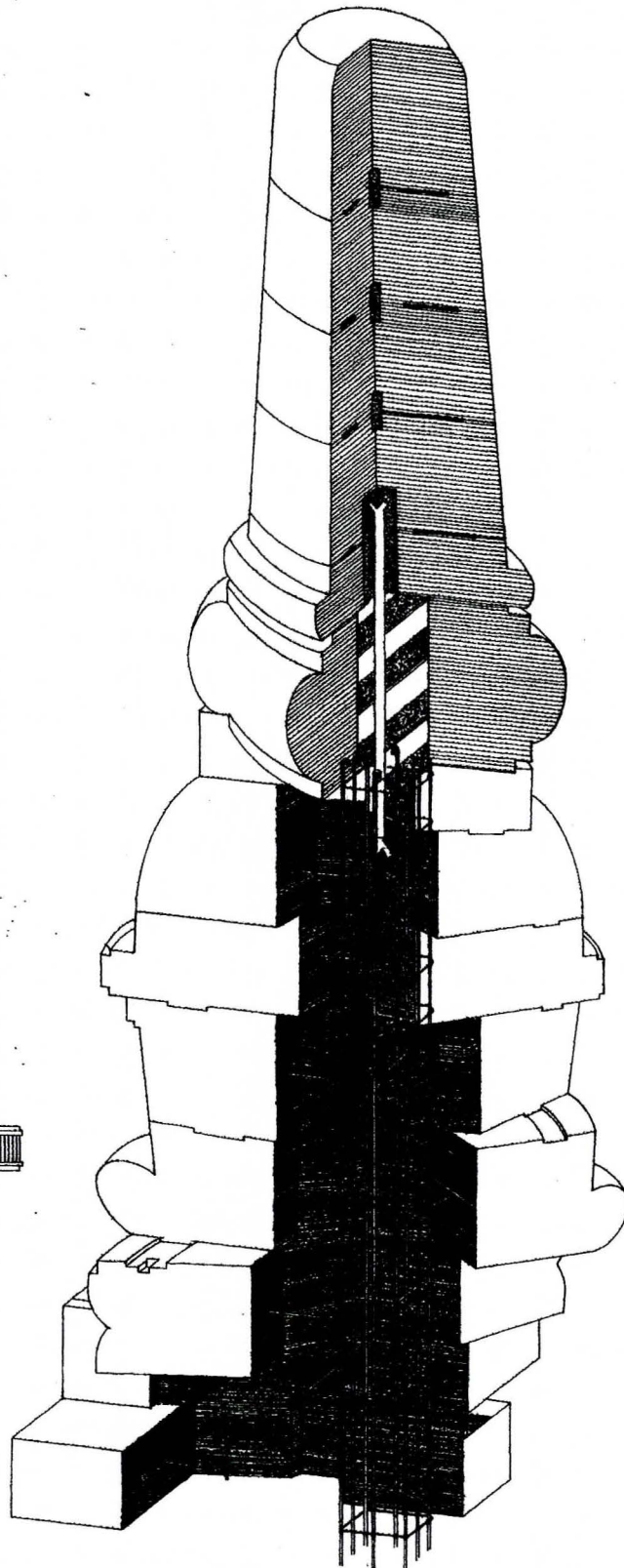
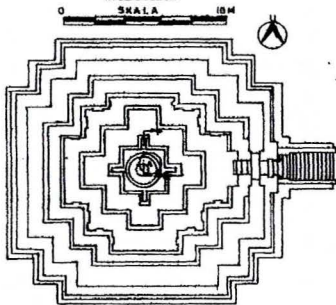

DETAIL : A

- Araldite dan mortar
- DF dan pasir
- Cor beton
- Batu terpotong
- Angkur (kuningan ø 3/8")
- Angkur (kuningan ø 1")

LAPORAN TRIWULAN KE IV

PROYEK

PEMUGARAN DAN PEMELIHARAAN PENINGGALAN SEJARAH DAN PURBAKALA DAERAH ISTIMEWA YOGYAKARTA

TAHUN ANGGARAN 1985-1986

UNIT

CANDI BRAHMA

LOKASI

DESA : KARANGASEH BOJONGHARJO

KECAMATAN : PRAMBANAN

KABUPATEN : SLEMAN

GAMBAR

ISOMETRISCH
PENGOLESAN ARALDITE DAN MORTAR

SKALA
1:10

TANGGAL
7 MEI 1986

UKURAN
50 x 62

LEMBAR

NO GAMBAR
1180349/02/86

DUKUR : PARWITO

DIGAMBAR : PARWITO

DIPERIKSA TA : [Signature]

DIREKTOR UNIT : [Signature]

DISEY KOLAN PUGAR : Drs. THAQ. SOENAR TO

DISEY. PM. PRO. : Drs. Y. TRIPUDJASTUTI

The restoration and maintenance of historical and archaeological heritage in Special District of Jogjakarta

**DIAN LARA JONGGRANG
CANDI BRAHMA
R detail PENULANGAN
TAP TK IV DAN KEMUNCAK**



IPANG A-B
Skala 1:50

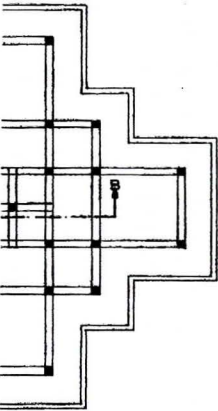

AH 1:50

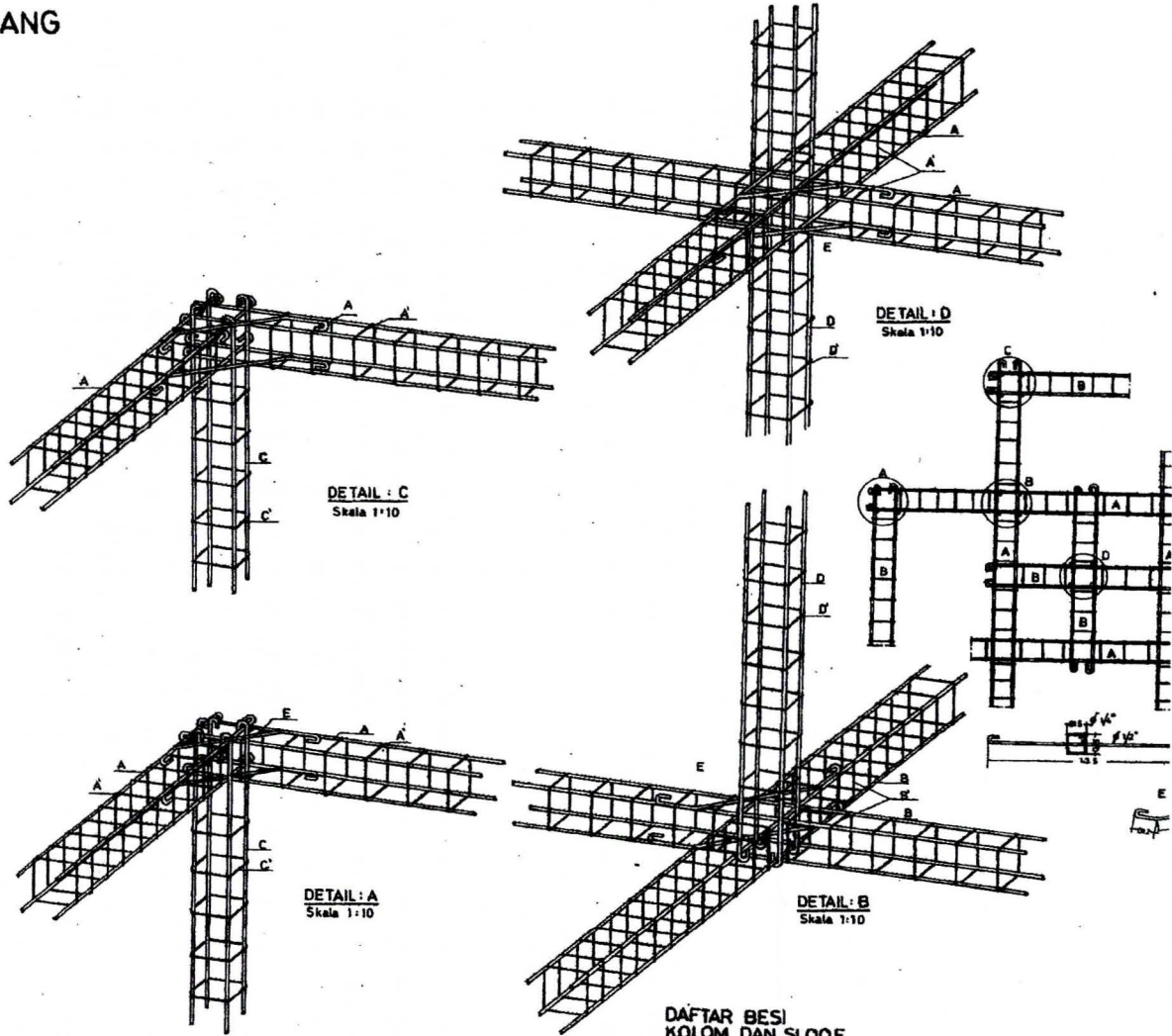

Erecting a Framework of Brahma

The detail of erecting a framework of roof level 4 and the peak

**DAFTAR BESI
KOLOM DAN SLOOF**

NO	KODE TILANGAN	DIAMETER BESI	JAYNA BESI DALAM M	BANYAK BATANG	KETERANGAN
1	A	Ø 1/2"	40	4	
	Z	Ø 1/4"	68	4	
2	B	Ø 1/2"	34	5	
	D	Ø 1/4"	30	5	
3	C	Ø 1/2"	26	2	
	A	Ø 1/4"	44	2	
4	D	Ø 1/2"	14	1	
	B	Ø 1/4"	24	2	
5	E	Ø 1/4"	28	3	

PROYEK PEM
PENINGGALAN
[Signature]
1/1/19

Candi Siwa
Potongan Tegak
(Up right of Siwa temple)

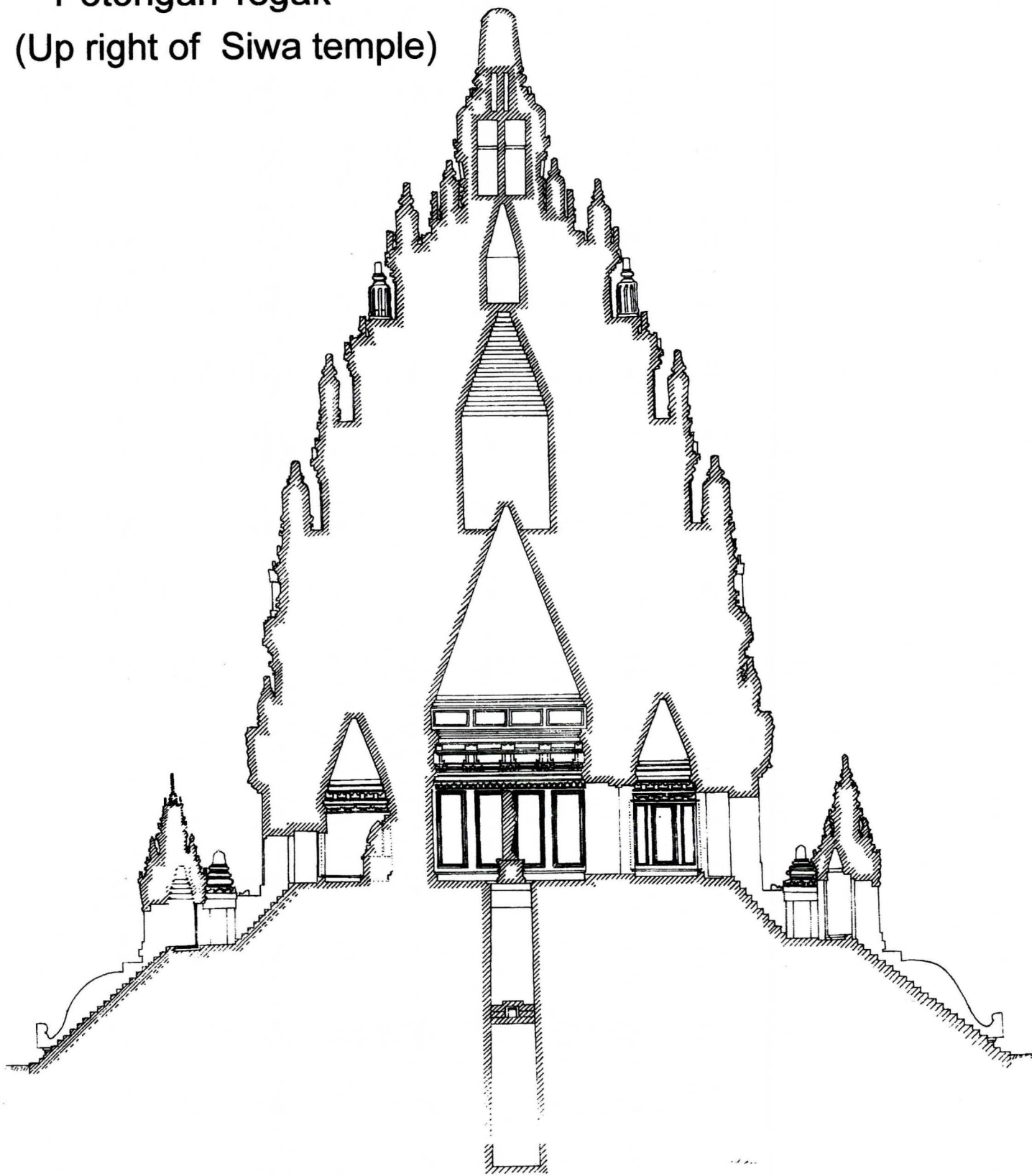

Wisnu Temple

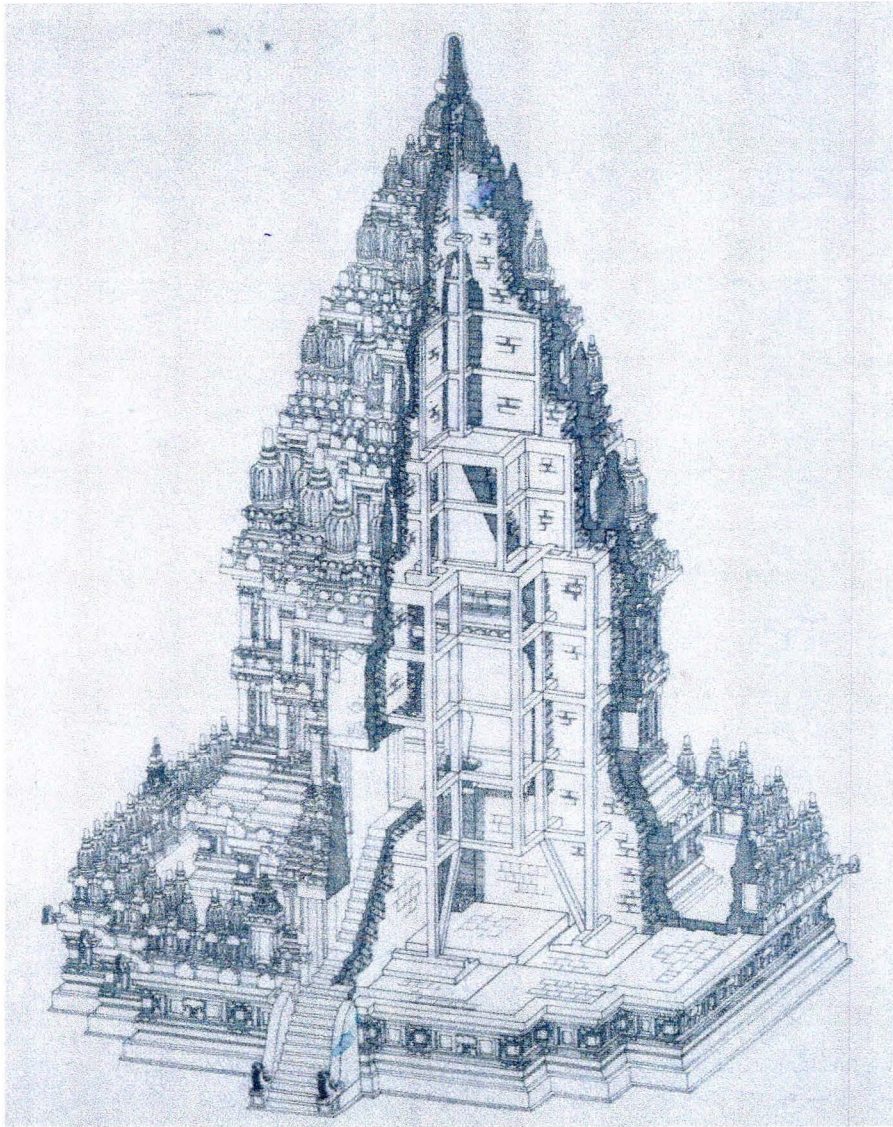

Isometric Framework of Concrete

Candi Wisnu

Rencana Pemasangan Batu Langkan

(The balustrade construction plan of Wisnu temple)

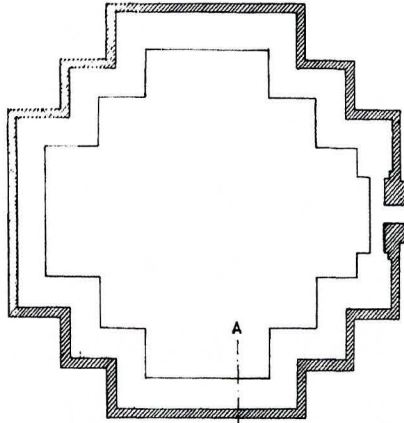

DENAH
SKALA 1:200

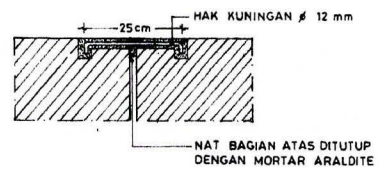

DETAIL A
SKALA 1:10

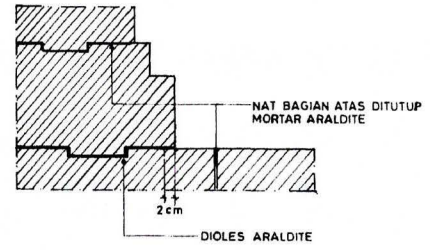

DETAIL B
SKALA 1:10

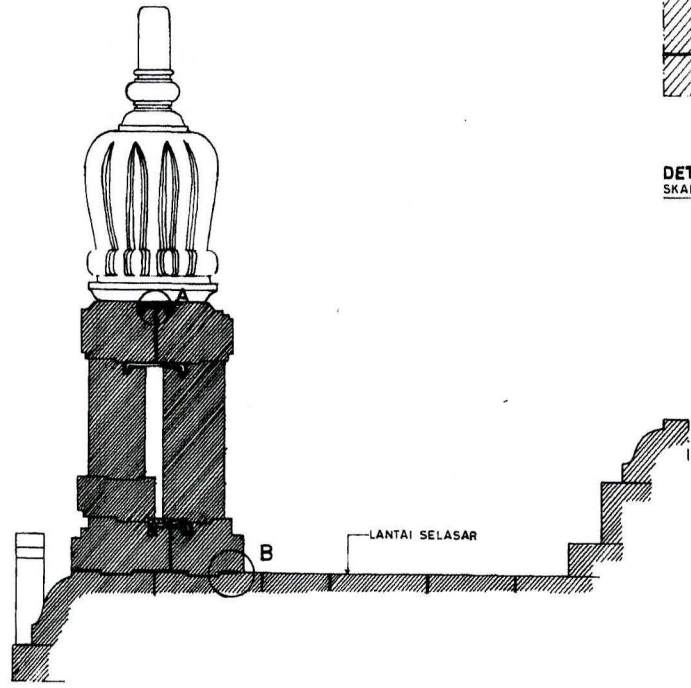

POTONGAN A A
SKALA 1:20

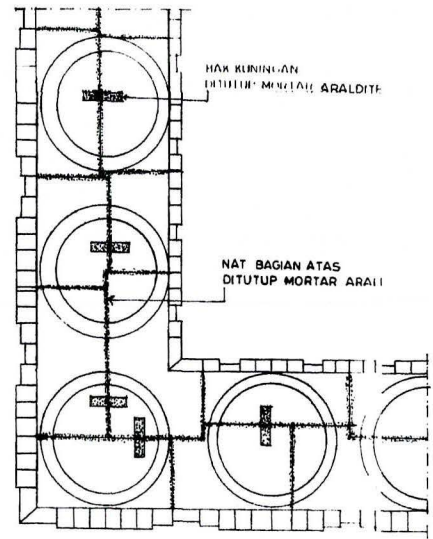

DETAIL DUDUK AMALAKA
SKALA 1:20

Candi Wisnu

(Wisnu Temple)

Susunan Kembali Batu Bingkai
Rata Duduk Amalaka A.U. V
Lapis 61-63

(The rearrangement of flat settled
Amalaka frame A.U.V. Layer 61-63)

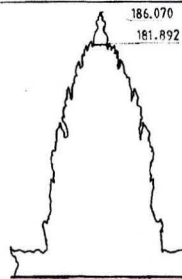
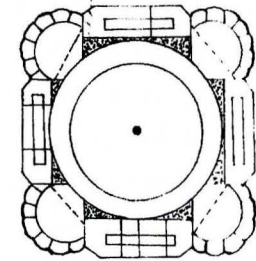
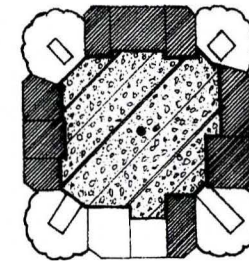
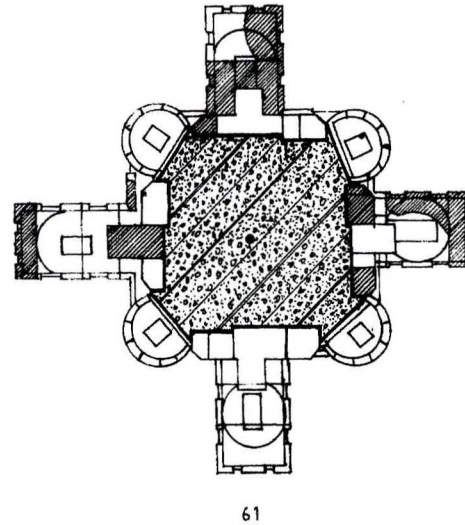
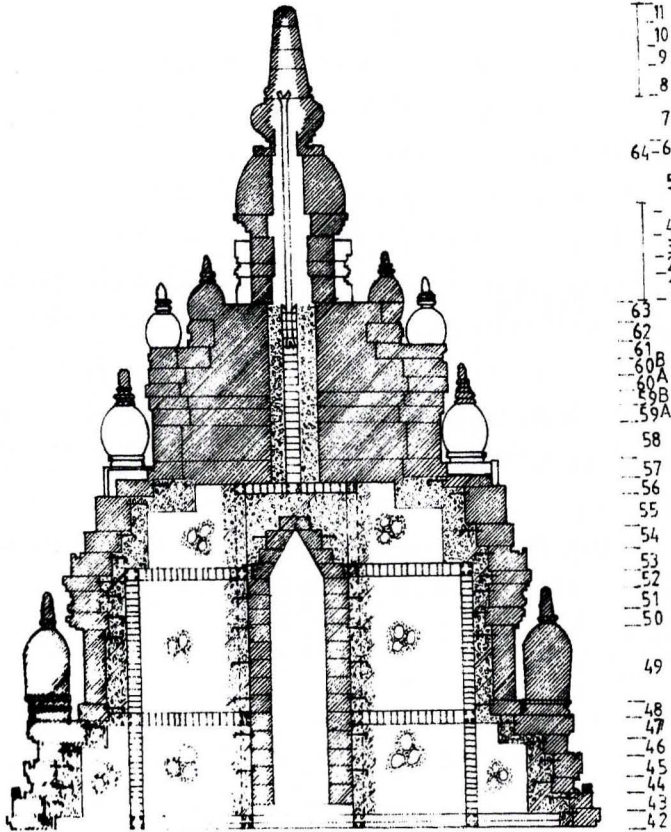

MT 153 - 463 01

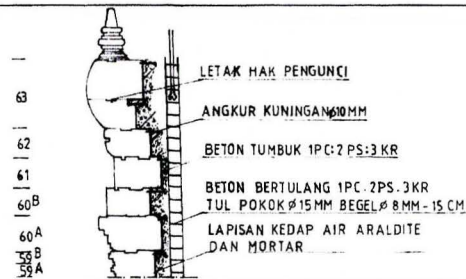

LETAK HAK PENGUNCI

ANGKUR KUNINGAN Ø 10 MM



BETON TUMBUK 1PC:2 PS:3 KR

BETON BERTULANG 1PC. 2PS. 3KR
TUL POKOK Ø 15 MM BEGEL Ø 8 MM - 15 CM

LAPISAN KEDAP AIR ARAALDITE
DAN MORTAR



NOTASI

-  BATU BARU / PENGGANTI
-  BATU LAMA / ASLI

Perpustakaan Dirjen
Jenderal Kebudayaan

930.1
TEC